



NI 43-101 Technical Report on Itafos Conda and Paris Hills Mineral Projects, Idaho, USA *for Itafos*

Effective Date: July 1, 2019

Authors:

Qualified Person	Professional Designation	Company	Title
Edward H. Minnes	P.E.	Golder Associates Inc.	Associate and Mining Practice Leader
Jerry DeWolfe	P.Geo.	Golder Associates Ltd.	Associate and Senior Geologist
Jennifer Simper	P.Geo.	Golder Associates Ltd.	Project Geologist
Mitchell J. Hart	P.E.	Arcadis	Principal Engineer
Dr. Francisco J. Sotillo	Q.P.	PerUsa EnviroMet, Inc.	President

Published: December 2019

NOTICE TO READERS: This National Instrument 43-101 Technical Report for ITAFOS was prepared and executed by the Qualified Persons named herein as Authors. This report contains the expressions of professional opinions of the Authors based on (i) information available at the time of preparation, (ii) data supplied by ITAFOS, and (iii) the assumptions, conditions, and qualifications set forth in this report. The quality of information, conclusions, and estimates contained herein are consistent with the stated levels of accuracy as well as the circumstances and constraints under which the mandate was performed. This report is intended to be used solely by ITAFOS, subject to the terms and conditions of its contract with Golder Associates, Inc. This contract permits ITAFOS to file this report as a Technical Report with Canadian securities regulators pursuant to National Instrument 43-101 - Standards of Disclosure for Mineral Projects. Except for the purposes legislated under Canadian securities law, any use of this report by any third party is at that party's sole risk.

Date & Signature Page

This Technical Report on the Itafos Conda and Paris Hills Mineral Projects is submitted to ITAFOS and is effective as of July 1, 2019.

Qualified Person	Responsible for Parts
Edward H. Minnes, P.E. Golder Associates Inc. <i>Signature on file</i> Date Signed: December 12, 2019	Items 1.1, 1.4, 1.5.2, 1.6.2, 2, 3, 4, 5, 6, 15, 16, 18, 19, 21, 22, 23, 24.1, 24.2, 25, 26.3 and 27
Jerry C. DeWolfe, P.Geo. Golder Associates Ltd. <i>Signature on file</i> Date Signed: December 12, 2019	Items 1.2, 1.3, 1.5.1, 1.6.1, 7 through 11, Item 12 (excluding Paris Hills data verification), 14, 24.3 and 26.1.
Mitchell J. Hart, P.E P-5517, State of Idaho Arcadis <i>Signature on file</i> Date Signed: December 9, 2019	Item 20
Dr. Francisco J. Sotillo, QP PerUsa EnviroMet, Inc. <i>Signature on file</i> Date Signed: December 6, 2019	Items 1.6.3, 13, 17, and 26.2
Jennifer N. Simper, P.Geo., Golder Associates Ltd. <i>Signature on file</i> Date Signed: December 12, 2019	Item 12

CERTIFICATE OF QUALIFIED PERSON EDWARD H. MINNES

I, Edward H. Minnes, state that:

- (a) I am an Associate and Mining Practice Leader at:
Golder Associates.

7245 W Alaska Drive, Suite 200

Lakewood, CO, 80226

- (b) This certificate applies to the technical report titled, "NI 43-101 Technical Report on Itafos Conda and Paris Hills Mineral Projects, Idaho, USA" with an effective date of: an effective date of: July 1, 2019 (the "Technical Report").
- (c) I am a "qualified person" for the purposes of National Instrument 43-101 (the "Instrument"). My qualifications as a qualified person are as follows. I am a graduate of Queens University with Bachelor of Science in Mining Engineering, in 1984. I am a professional engineer of the state of Missouri (License Number 023956), and Registered Member of the Society for Mining, Metallurgy and Exploration Inc. (SME Member Number 4044440RM). My relevant experience after graduation and over 33 years for the purpose of the Technical Report includes 13 years in operating open pit metal mines and 20 years in consulting with a focus on open pit mining.
- (d) My most recent personal inspection of each property described in the Technical Report occurred on October 10th, 2019 and was for a duration of 11 days.
- (e) I am responsible for Item(s) 1.1, 1.4, 1.5.2, 1.6.2, 2, 3, 4, 5, 6,15, 16, 18, 19, 21, 22, 23, 24.1, 24.2, 25, 26.3 and 27 of the Technical Report.
- (f) I am independent of the issuer as described in section 1.5 of the Instrument.
- (g) I have not had prior involvement with the property that is the subject of the Technical Report.
- (h) I have read National Instrument 43-101. The part of the Technical Report for which I am responsible has been prepared in compliance with this Instrument; and
- (i) At the effective date of the Technical Report, to the best of my knowledge, information, and belief, the parts of Technical Report for which I am responsible, contains all scientific and technical information that is required to be disclosed to make the Technical Report not misleading.

Dated at Lakewood, CO this 12 day of December, 2019

(signed and sealed)

"Edward H. Minnes"

Edward H. Minnes, P.E.

Golder Associates Inc.

CERTIFICATE OF QUALIFIED PERSON JERRY DEWOLFE, P.GEO.

I, Jerry C. DeWolfe, P.Geo., state that:

- (a) I am an Associate and Senior Geological Consultant at:
Golder Associates Ltd.

2800, 700 – 2nd Street SW

Calgary, Alberta, Canada, T2P 2W2
- (b) This certificate applies to the technical report titled “NI 43-101 Technical Report on Itafos Conda and Paris Hills Mineral Projects, Idaho, USA” with an effective date of: July 1, 2019 (the “Technical Report”).
- (c) I am a “qualified person” for the purposes of National Instrument 43-101 (the “Instrument”). My qualifications as a qualified person are as follows. I am a graduate of Laurentian University, Sudbury, Ontario (M.Sc. Geology, 2006) and Saint Mary’s University, Halifax, Nova Scotia (B.Sc. with honors in Geology, 2000), and I am a member in good standing of the Association of Professional Engineers and Geoscientists of Alberta (APEGA), the Association of Professional Engineers and Geoscientists of British Columbia (APEGBC), and the Association of Professional Geoscientists of Ontario (APGO). My relevant experience after graduation and over 19 years for the purpose of the Technical Report includes exploration, mine geology and resource estimation of phosphate, potash, evaporites, coal and other stratigraphically controlled deposits.
- (d) My most recent personal inspection of each property described in the Technical Report occurred on April 15 through 18 2019 (Rasmussen Valley Mine, Lanes Creek Mine and Paris Hills) and September 16 through 18 2019 (Husky1 Project and North Dry Ridge Project) and was for a duration of 4 and 3 days respectively.
- (e) I am responsible for Items 1.2, 1.3, 1.5.1, 1.6.1, 7 through 11, Item 12 (excluding Paris Hills data verification), 14, 24.3 and 26.1 of the Technical Report.
- (f) I am independent of the issuer as described in section 1.5 of the Instrument.
- (g) I have not had prior involvement with the property that is the subject of the Technical Report.
- (h) I have read National Instrument 43-101. The part of the Technical Report for which I am responsible has been prepared in compliance with this Instrument; and
- (i) At the effective date of the Technical Report, to the best of my knowledge, information, and belief, the parts of Technical Report for which I am responsible, contains all scientific and technical information that is required to be disclosed to make the Technical Report not misleading.

Dated at Calgary, Alberta this 12 day of December 2019.

(signed and sealed)

"Jerry C. DeWolfe"

Jerry C. DeWolfe, P.Geo.

Golder Associates Ltd.

CERTIFICATE OF QUALIFIED PERSON JENNIFER N. SIMPER, P.GEO.

I, Jennifer N. Simper, P.Geo., state that:

- (a) I am a Senior Project Geologist at:
Golder Associates Ltd.

2800, 700 – 2nd Street SW

Calgary, Alberta, Canada, T2P 2W2
- (b) This certificate applies to the technical report titled “NI 43-101 Technical Report on Itafos Conda and Paris Hills Mineral Projects, Idaho, USA” with an effective date of: July 1, 2019 (the “Technical Report”).
- (c) I am a “qualified person” for the purposes of National Instrument 43-101 (the “Instrument”). My qualifications as a qualified person are as follows. I am a graduate of the University of Calgary, (B.Sc. in Geology, 2006), and I am a member in good standing of the Association of Professional Engineers and Geoscientists of Alberta (APEGA). My relevant experience after graduation and over 13 years for the purpose of the Technical Report includes exploration, mine geology and resource estimation of phosphate, evaporites, coal and other stratigraphically controlled deposits.
- (d) I am responsible for Item 12 (Paris Hills data verification) of the Technical Report.
- (e) I am independent of the issuer as described in section 1.5 of the Instrument.
- (f) I have not had prior involvement with the property that is the subject of the Technical Report.
- (g) I have read National Instrument 43-101. The part of the Technical Report for which I am responsible has been prepared in compliance with this Instrument; and
- (h) At the effective date of the Technical Report, to the best of my knowledge, information, and belief, the parts of Technical Report for which I am responsible, contains all scientific and technical information that is required to be disclosed to make the Technical Report not misleading.

Dated at Calgary, Alberta this 12 day of December 2019.

(signed and sealed)

"Jennifer N. Simper"

Jennifer N. Simper, P.Geo.

Golder Associates Ltd.

CERTIFICATE OF QUALIFIED PERSON – Mitchell J. Hart, P.E.

I, Mitchell J. Hart, P.E., state that:

- (a) I am a Principal Engineer at:Arcadis US, Inc.
95 East Hooper Avenue
Soda Springs, Idaho 83276
- (b) This certificate applies to the technical report titled NI 43-101 Technical Report on Itafos Conda and Paris Hills Mineral Projects, Idaho, USA with an effective date of: July 1, 2019 (the "Technical Report").
- (c) I am a "qualified person" for the purposes of National Instrument 43-101 (the "Instrument"). My qualifications as a qualified person are as follows. I am a graduate of the University of Utah with a Bachelor of Science degree in Mining Engineering (1981). I am a licensed/registered professional engineer (PE) with the State of Idaho, License No. P-5517. I am a member of the Society of Mining, Metallurgy and Exploration (SME), Member No. 01351130. My relevant experience after graduation and over 38 years for the purpose of the Technical Report includes mine: permitting, exploration, development, operations, reclamation and closure as well as historic / legacy mine remediation working for the following companies – Shell Mining, Monsanto, Terra Systems/ Mountain Island Energy, Agrium, Great Ecology, GHD and H2H Resources, PLLC and Arcadis.
- (d) My most recent personal inspection of each property described in the Technical Report occurred on March 11, 2019 and April 18, 2019 and was for a duration of a portion of a day each.
- (e) I am responsible for Item 20 of the Technical Report.
- (f) I am independent of the issuer as described in Section 1.5 of the Instrument.
- (g) My prior involvement with the property that is the subject of the Technical Report is as follows: Having worked in the "Phosphate Patch" of southeast Idaho for more than 33 years, I am quite familiar with the majority of past, present and future phosphate properties, mines and resources. As a former employee of Agrium, I was involved in – the acquisition of the Lanes Creek Mine and the early stages of its permitting and the early stages of permitting of the Rasmussen Valley, Husky 1 and North Dry Ridge Mines.
- (h) I have read National Instrument 43-101. The parts of the Technical report for which I am responsible have been prepared in compliance with this Instrument; and
- (i) At the effective date of the Technical Report, to the best of my knowledge, information, and belief, the parts of the Technical Report for which I am responsible, contains all scientific and technical information that is required to be disclosed to make the Technical Report not misleading.

Dated at Soda Springs, Idaho this 9 day of December 2019.

(signed and sealed)

"Mitchell J. Hart"

Mitchell J. Hart, PE

P-5517, State of Idaho

Arcadis

CERTIFICATE OF QUALIFIED PERSON FRANCISCO J. SOTILLO, QP

I, Dr. Francisco J. Sotillo, QP, state that:

(a) I am President at:

PerUsa EnviroMet, Inc.

228 Pinellas Street

Lakeland, Florida 33803-4832

USA

- (b) This certificate applies to the technical report titled NI 43-101 Technical Report on Itafos Conda and Paris Hills Mineral Projects, Idaho, USA with an effective date of: July 1, 2019 (the "Technical Report").
- (c) I am a "qualified person" for the purposes of National Instrument 43-101 (the "Instrument"). My qualifications as a qualified person are as follows. I am a graduate of the National University of Engineering, Lima, Peru, with a BS in Metallurgy (1977), the University of California at Berkeley with a MS of Engineering in Materials Science and Mineral Engineering (1985), and a PhD. of Engineering in Materials Science and Mineral Engineering (1995); and member of the Member of the Professional Institute of Engineers of Peru, CIP No.: 23688 (1983), Member of the Society of Mining, Metallurgy and Exploration, Inc., Member No. 03037370; Member of the Mining and Metallurgical Society of America as a QP Member in Metallurgy/Processing, Member No.: 01473QP (2014). My relevant experience after graduation and over 42 years for the purpose of the Technical Report includes starting as a foreman at a mining company, and being now a recognized expert in the beneficiation of phosphate ores. I have worked as a Metallurgical Consultant for KEMWorks Technology, Inc., Pegasus TSI, Inc., Mosaic Company, Agrium Company, JR Simplot Phosphate Ltd., PCS Phosphates, CF Industries, Cargill Fertilizer, among many other clients. I am author of more than 40 publications on phosphate, sulfides, coal, and metallic ores. Since 2008, I am President of PerUsa EnviroMet, Inc..
- (d) My most recent personal inspection of each property described in the Technical Report occurred on June 18, 2019 and was for a duration of one day.
- (e) I am responsible for Items 1.6.3, 13, 17, and 26.2 of the Technical Report.
- (f) I am independent of the issuer as described in section 1.5 of the Instrument.
- (g) I have not had prior involvement with the property that is the subject of the Technical Report.
- (h) I have read National Instrument 43-101. The parts of the Technical report for whom I am responsible have been prepared in compliance with this Instrument; and
- (i) At the effective date of the Technical Report, to the best of my knowledge, information, and belief, the parts of the Technical Report for which I am responsible, contains all scientific and technical information that is required to be disclosed to make the Technical Report not misleading.

Dated at Lakeland, Florida, USA this 6 day of December 2019.

(signed and sealed)

"Dr. Francisco J. Sotillo"

Dr. Francisco J. Sotillo, QP

PerUsa EnviroMet, Inc.

Table of Contents

1.0	SUMMARY	1-1
1.1	Property Description and Ownership	1-1
1.2	Geology and Mineralization	1-3
1.3	Exploration Status	1-4
1.4	Development and Operations Status	1-5
1.5	Mineral Resource and Mineral Reserve Estimates.....	1-7
1.6	QP’s Conclusions and Recommendations.....	1-12
2.0	INTRODUCTION	2-1
2.1	Itafos.....	2-1
2.2	Sources of Information	2-3
2.3	Personal Inspection Details.....	2-3
3.0	RELIANCE ON OTHER EXPERTS	3-1
3.1	Legal, Political, Environmental, or Tax Matters	3-1
3.2	Fertilizer Markets and Phosphate Rock Pricing.....	3-3
4.0	PROPERTY DESCRIPTION AND LOCATION	4-1
4.1	Locations and Areas	4-1
4.2	Mineral Tenure, Surface, and Other Rights	4-7
4.3	Environmental Liabilities	4-9
4.4	Permits	4-10
4.5	Significant Factors or Risks Affecting Access, Title, Right or, Ability to Work on the Property	4-12
5.0	ACCESSIBILITY, CLIMATE, LOCAL RESOURCES INFRASTRUCTURE, AND PHYSIOGRAPHY	5-1
5.1	Topography, Elevation, and Vegetation.....	5-1
5.2	Accessibility.....	5-2
5.3	Climate	5-8
5.4	Sufficiency of Surface Rights, Site, and Local Resources.....	5-8
6.0	HISTORY	6-1

6.1	Prior Ownership and Ownership Changes.....	6-1
6.2	Exploration and Development History.....	6-4
6.3	Historical Mineral Resource and Mineral Reserve Estimates.....	6-8
6.4	Production from the Property	6-9
7.0	GEOLOGICAL SETTING AND MINERALIZATION.....	7-1
7.1	Regional Geology.....	7-1
7.2	Itafos Conda Projects Geology	7-6
7.3	Paris Hills Project Geology.....	7-13
8.0	DEPOSIT TYPES.....	8-1
9.0	EXPLORATION.....	9-1
9.1	RVM and LCM Grade Control Trench Samples.....	9-1
9.2	NDR Exploration Trench Samples	9-2
9.3	PH Exploration Trench and Adit Samples.....	9-2
9.4	Wireline Geophysical Logs.....	9-3
9.5	PH Project Seismic Surveys	9-4
9.6	Regional and Deposit Scale Geological Mapping.....	9-4
10.0	DRILLING.....	10-1
10.1	Drilling Methods	10-1
10.2	Impacts of Drilling on the Accuracy and Reliability of the Results.....	10-13
10.3	Relationship Between Drill Intercept Angles and Bed Contacts	10-15
11.0	SAMPLE PREPARATION, ANALYSES, AND SECURITY	11-1
11.1	Itafos Conda Projects Sample Preparation.....	11-1
11.2	PH Project Sample Preparation	11-3
11.3	QP Statement on the Adequacy of Sample Preparation, Security and Analytical Procedures	11-6
12.0	DATA VERIFICATION	12-1
12.1	Data Verification Procedures	12-1
12.2	Limitations on Data Verification	12-7
12.3	QP's Statement on Adequacy of Data	12-7
13.0	MINERAL PROCESSING AND METALLURGICAL TESTING	13-1

13.1	Phosphate Ore Feed Preparation	13-1
13.2	Summary of Phosphate Ore and Products Characterization Studies.....	13-2
13.2.1	Wash Plant Feed – Head.....	13-3
13.2.2	Wash Plant Feed – Screen Assays	13-3
13.2.3	Wash Plant Feed – Mineralogy.....	13-7
13.2.4	Wash Plant Beneficiation Product Characterization	13-8
13.2.5	Wash Plant Tailings Characterization	13-9
13.3	Wash Plant Scrubbing Unit Operation	13-10
13.4	Sizing and Classification Unit Operations	13-11
13.5	Crushing and Grinding Unit Operations	13-12
13.6	Dewatering Unit Operations.....	13-14
13.7	Metallurgical Balance	13-14
13.8	Summary and Conclusions	13-15
14.0	MINERAL RESOURCE ESTIMATES.....	14-1
14.1	Basis for Mineral Resource Estimate.....	14-1
14.2	Key Assumptions, Parameters and Methods Used to Estimate the Mineral Resources	14-2
14.3	Mineral Resource Estimation	14-9
15.0	MINERAL RESERVE ESTIMATES	15-1
16.0	MINING METHODS	16-1
16.1	Geotechnical	16-1
16.2	Pit Design.....	16-2
16.3	Production Schedule	16-8
17.0	RECOVERY METHODS	17-1
17.1	Wash Plant Description.....	17-1
17.2	Materials and Water Distributions	17-7
17.3	Process Control and Wash Plant Sampling.....	17-7
17.4	Performance.....	17-8
17.5	Wash Plant Upgrades for Processing H1 and NDR Ores.....	17-9
18.0	PROJECT INFRASTRUCTURE	18-1

19.0 MARKET STUDIES AND CONTRACTS	19-1
19.1 CRU Market Study	19-1
19.2 Gross Margins Available for Mined Phosphate Ores	19-6
19.3 Material Contracts	19-9
20.0 ENVIRONMENTAL STUDIES, PERMITTING, AND SOCIAL OR COMMUNITY IMPACT	20-1
20.1 Environmental Studies	20-1
20.2 Overburden Disposal, Tailings Disposal, Water Management, and Site Monitoring	20-4
21.0 CAPITAL AND OPERATING COSTS	21-1
22.0 ECONOMIC ANALYSIS	22-1
23.0 ADJACENT PROPERTIES.....	23-1
24.0 OTHER RELEVANT DATA AND INFORMATION.....	24-1
24.1 H1 and NDR Preliminary Economic Assessment (Mining).....	24-1
24.2 Itafos Conda Phosphate Plant	24-7
24.3 Exploration Targets	24-10
25.0 INTERPRETATION AND CONCLUSIONS	25-1
25.1 Geology and Mineral Resource Estimates.....	25-1
25.2 Mining and Mineral Reserve Estimates	25-3
26.0 RECOMMENDATIONS	26-1
26.1 Geology and Mineral Resource Estimation Recommendations	26-1
26.2 Metallurgy Recommendations	26-2
26.3 Mining.....	26-3
27.0 REFERENCES.....	27-1
27.1 Acronyms and Abbreviations	27-1
27.2 Works Sited.....	27-5

TABLES

- Table 1-1: Summary of Available Drilling Data by Project
- Table 1-2: Summary of Estimated Mineral Resources – Effective Date July 1, 2019
- Table 1-3: Summary of Estimated Mineral Reserves by Mine and Classification – Effective Date July 1, 2019
- Table 2-1: Site Visit Details
- Table 3-1: Sources of Information
- Table 4-1: Location and Acreage: Itafos Conda and Paris Hills Projects
- Table 4-2: Mineral Tenure, Surface, and Other Rights for Itafos Conda and Paris Hills Projects
- Table 4-3: Current Environmental Liabilities by Project
- Table 4-4: Permits Acquired and to be Acquired for Itafos Mines and Projects
- Table 6-1: Historical Mineral Resource and Reserves Estimates for Itafos Conda Projects
- Table 7-1: Conda Projects Mineralized Zone Average Thicknesses
- Table 7-2: Paris Hills Project Mineralized Zone Average Thicknesses
- Table 9-1: Summary of Drill Holes with Available Wireline Gamma Logs by Project
- Table 10-1: Drilling Data Summary by Itafos Conda Project
- Table 10-2: Drilling Data Summary for the Paris Hills Project
- Table 12-1: Collar Elevation versus Topographic Elevation Summary Statistics
- Table 13-1: Wash Plant Feed – Chemical Analysis (2018-2019)
- Table 13-2: Screen Analysis and Screen Assay of the Wash Plant Feed of June 19, 2019
- Table 13-3: Particle Liberation Data of North Rasmussen Ridge Mine
- Table 13-4: Beneficiation Product of the Wash Plant – Chemical Analysis (2018-2019)
- Table 13-5: Tailings of the Wash Plant – Chemical Analysis and Physical Parameters (2018-2019)
- Table 13-6: Metallurgical Balance of the Wash Plant (2018-2019)
- Table 14-1: Itafos Conda Projects Model Bed Names
- Table 14-2: PH Project Model Bed Names
- Table 14-3: Block Model Spatial Extents and Block Size Parameters for Each Model
- Table 14-4: Itafos Conda projects Block Model Parameters
- Table 14-5: PH Block Model Parameters
- Table 14-6: Itafos Conda Projects Resource Pit Shell Cost Parameters
- Table 14-7: Paris Hills (PH) Resource Constraint Cost Parameters
- Table 14-8: Mineral Resource Categorization Criteria by Project
- Table 14-9: Summary of Estimated Mineral Resources – Effective Date July 1, 2019

Table 15-1: Modifying Factors for Determining Geological Model Block Values (As of July 1, 2019)
Table 15-2: Estimated Mineral Reserves - Effective Date July 1, 2019
Table 16-1: RVM and LCM Geotechnical Parameters
Table 16-2: Mine Production Schedule to Wooley Valley Tipple ^a
Table 17-1: H1 Composite 1 and Composite 1+2, >20% P ₂ O ₅
Table 17-2: Chemical Analysis of Rasmussen Valley Mine LOI#2 and LOI#3 Model for H1 and Composites
Table 17-3: Screen Assay of H1 Composite 1, >20% P ₂ O ₅ ¹
Table 17-4: Screen Assay of H1 Composite 1+2 >20% P ₂ O ₅
Table 17-5: Screen Assay of Blend Feed of RVM as H1 Phosphate Ore Model ⁴
Table 17-6: Apatite Liberation Studies for H1 Composite 1, >20% P ₂ O ₅
Table 17-7: Apatite Liberation Studies for H1 Composite 1+2, >20% P ₂ O ₅
Table 17-8: Metallurgical Balance for H1 without Flotation
Table 17-9: Metallurgical Balance for H1 with Flotation
Table 17-10: CAPEX Estimates +/-50% Level
Table 19-1: Forecast Prices for MAP and SPA (Real 2019\$ terms)
Table 19-2: Estimated Gross Margins Available for LCM/RVM Phosphate Ore in 2019 and 2025 (real 2019\$ terms)
Table 19-3: Estimated Gross Margins Available for LCM/RVM Phosphate Ore from 2019 to 2025 (real 2019\$ terms)
Table 21-1: Summary of Economic Assumptions
Table 21-2: Mean Operating Cost (US\$)
Table 22-1: DCF Forecast (real 2019\$ terms)
Table 22-2: Economic Analysis – Comparison of Transfer Prices with Gross Margins Available (real 2019\$ terms)
Table 22-3: Operating Cost Sensitivity Analysis (real 2019\$ terms)
Table 22-4: Grade Sensitivity Analysis (real 2019\$ terms)
Table 24-1: Preliminary Economic Assumptions
Table 24-2: H1 and NDR Geotechnical Parameters
Table 24-3: Mine Plan Statistics and Economic Analysis

FIGURES

Figure 2-1: Property Location Map

Figure 4-1: Rasmussen Valley and Lanes Creek Mine Property Map

Figure 4-2: Husky 1 Property Map

Figure 4-3: North Dry Ridge Property Map

Figure 4-4: Paris Hills Property Map

Figure 5-1: Itafos Conda Project Locations Map

Figure 5-2: Rasmussen Valley Mine and Lanes Creek Mine Projects Location Map

Figure 5-3: North Dry Ridge Location Map

Figure 5-4: Husky 1 Property Location Map

Figure 5-5: Paris Hills Location Map

Figure 7-1: Regional Geology Map

Figure 7-2: Typical Regional Stratigraphic Column

Figure 7-3: Rasmussen Valley Mine and Lanes Creek Mine Local Geology Map

Figure 7-4: Regional Cross Section, Snowdrift Anticline

Figure 7-5: North Dry Ridge Property Local Geology Map

Figure 7-6: Regional Cross Section, North Dry Valley Anticline, North Dry Ridge

Figure 7-7: Husky 1 Property Local Geology Map

Figure 7-8: Regional Cross Sections, North Dry Valley Anticline, H1

Figure 7-9: Paris Hills Local Geology Map

Figure 7-10: Regional Cross Sections – Paris Hills

Figure 10-1: Rasmussen Valley Mine and Lanes Creek Mine Drill Hole Location Map

Figure 10-2: North Dry Ridge Drill Hole Location Map

Figure 10-3: Husky 1 Drill Hole Location Map

Figure 10-4: Rasmussen Valley Mine Representative Cross Section

Figure 10-5: Lanes Creek Mine Representative Cross Section

Figure 10-6: North Dry Ridge Project Representative Cross Section

Figure 10-7: Husky 1 Project Representative Cross Section

Figure 10-8: Paris Hills Drill Hole Location Map

Figure 10-9: Paris Hills Project Representative Cross Section

Figure 13-1: Rollover, Belt Conveyors, Stackers, and Stockpiles

Figure 13-2: P_2O_5 , MgO , Al_2O_3 , Fe_2O_3 , CaO , and SiO_2 Grades as a Function of Particle Size for the Wash Plant Feed – June 19, 2019

Figure 13-3: Distribution of P_2O_5 , MgO , Al_2O_3 , Fe_2O_3 , CaO , and SiO_2 as a Function of Particle Size for the Wash Plant Feed – June 19, 2019

Figure 13-4: Cumulative Distribution of P_2O_5 , MgO , Al_2O_3 , Fe_2O_3 , CaO , and SiO_2 as a Function of Particle Size for the Wash Plant Feed – June 19, 2019

Figure 16-1: Double-Lane Design for 100-ton Class Haul Truck (Golder, 2019)

Figure 16-2: Single-Lane Design for 100-ton Class Haul Truck (Golder, 2019)

Figure 16-3: Rasmussen Valley Mine Ultimate Pit Design (Golder, 2019)

Figure 16-4: Lanes Creek Mine Ultimate Pit Design

Figure 16-5: Annual Production Schedule from RVM, LCM and Mine and Tipple Stockpiles Loaded at WV Tipple

Figure 16-6: Combined CPP Wash Plant Feed Schedule (Mine Production with Plant Stockpile) (Golder, 2019)

Figure 16-7: RVM 2019 Status (Golder, 2019)

Figure 16-8: Rasmussen Valley Mine 2020 Status (Golder, 2019)

Figure 16-9: Rasmussen Valley Mine 2021 Status (Golder, 2019)

Figure 16-10: Rasmussen Valley Mine 2022 Status (Golder, 2019)

Figure 16-11 Rasmussen Valley Mine 2023 Status (Golder, 2019)

Figure 16-12: Rasmussen Valley Mine 2024 Status (Golder, 2019)

Figure 16-13: Rasmussen Valley Mine 2025 Status (Golder, 2019)

Figure 16-14: Rasmussen Valley Mine 2026 Status (Golder, 2019)

Figure 16-15: Lanes Creek Mine 2019 Status (Golder, 2019)

Figure 16-16: Lanes Creek Mine 2020 Status (Golder, 2019)

Figure 17-1: Wash Plant Flowsheet

Figure 17-2: Materials and Water Balance – Conda Wash Plant Flowsheet

Figure 17-3: Potential Modified Flowsheet

Figure 18-1: Existing and Planned Infrastructure Map

Figure 19-1: Net-back MAP and Realized SPA Price Forecasts for 2019 – 2045 (\$/short ton, real 2019\$ terms)

Figure 23-1: Adjacent Properties Map

Figure 24-1: Preliminary NDR Ultimate Pit Design (Golder, 2019)

Figure 24-2: Preliminary H1 Ultimate Pit Design (Golder, 2019)

Figure 24-3: Preliminary H1 and NDR Mill Feed Schedule

1.0 SUMMARY

This Technical Report was prepared for Itafos, a vertically integrated phosphate fertilizers and specialty products company incorporated in the Cayman Islands and publicly traded on the TSX Venture Exchange (TSX-V: IFOS). Itafos owns Itafos Conda which includes the Conda Phosphate Plant (CPP) and associated mining operations located near Soda Springs, Idaho (ID). The CPP produces approximately 550 kt per year of monoammonium phosphate (MAP), MAP with micronutrients (MAP +), superphosphoric acid (SPA), merchant grade phosphoric acid (MGA) and specialty products including ammonium polyphosphate (APP). The CPP also includes a wash plant that treats mined phosphate ores delivered by rail to produce the phosphate rock feedstock required by the chemical plant. All ore delivered to the CPP is produced from Itafos' captive mines in southeastern ID, USA.

Itafos engaged Golder to compile this National Instrument (NI) 43-101 Technical Report (TR) on its ID mineral projects that are in operation or under development. The mines and projects are owned by its wholly owned subsidiaries, Itafos Conda LLC (Itafos Conda) and Paris Hills Agricom Inc. (PHA). Itafos Conda LLC operates the Rasmussen Valley Mine (RVM) and the Lanes Creek Mine (LCM) and is developing the nearby Husky 1 (H1) Project and North Dry Ridge (NDR) Project. Mined phosphate ore is and will continue to be delivered from these mines and projects to rail loadouts and transported via the Union Pacific Railroad (UPRR) to the CPP.

PHA is conducting further studies at the Paris Hills (PH) Project, which is located near Bloomington, ID. Paris Hills is being studied as a potential long-term future source of underground mined phosphate rock for the CPP.

1.1 Property Description and Ownership

Project Description and Location

The Property consists of the four Itafos Conda projects with a total area of 2,840 acres, and the PH Project with an area of 2,500 acres. The projects are located in Caribou County and Bear Lake County, ID, respectively. Itafos' title to the projects are leases from private, state and federal surface and mineral owners. Annual surface rental payments are required to maintain the leases and production royalties are paid on ore delivered from each lease to the CPP or rail loadout depending on the terms of each lease. Royalty rates are based on federal regulations. Currently the federal leases expire in 2035 at RVM, 2036 at H1, and 2023 at NDR. State leases expire in 2023 at NDR and at PH. Private leases at PH expire in 2021, 2022, 2028, and 2032. Itafos expects to extend all leases that are needed for production or development in the ordinary course of its business.

Current asset retirement obligations are estimated to be \$4.8 Million at LCM and \$52.0 Million at RVM for reclamation of the active mining operations.

The location of known phosphate mineralization at the projects is within the Upper and Lower Zones of the Meade Peak Member of the Phosphoria Formation. Mine workings and all other mine development structures exist at the RVM and LCM for annual ore production of approximately 2.2 Million dry short tons. The H1 and NDR projects are in the intermediate development stage of planning and permitting. PH is a longer-term development project undergoing further technical studies. The UPRR currently provides service from the Itafos rail loadout at the Wooley Valley Tipple (WV Tipple) located near RVM to the CPP.

Itafos has obtained all permits needed for operations at RVM and LCM. Itafos must acquire all permits required to develop and mine H1 and NDR including federal, state and county permits. In addition to the federal National Environmental Policy Act (NEPA) Environmental Impact Statement (EIS) process, special use permits (SUP) may be required from federal, state and county authorities, and may include but not be limited to air permit, stormwater general permit, permit to construct a drinking water system, septic system permit, stream alteration permit, and

wetlands [US Army Corp of Engineers (USACE) 404 Permit] permit. No permits are currently required for the engineering studies planned at PH.

Accessibility, Climate, Local Resources, Infrastructure, and Physiography

Access to the each of the projects is via local roads connected to state and federal highways. The Itafos Conda Projects are located about 15 miles northeast of the town of Soda Springs, ID. Soda Springs is 60 miles east of Pocatello, ID, and 175 miles north of Salt Lake City, Utah. PH is about 140 miles north of Salt Lake City, Utah and 40 miles south of Soda Springs, ID. It is just to the west of the towns of Bloomington and Paris, ID.

Southeastern ID has a temperate dry continental climate with warm summers and cold winters. Winter temperatures may fall below freezing from November through May especially in elevations above 6,500 feet. Total snowfall in the region will reach over 100 inches per year. The freezing temperatures restrict rail operations from RVM and LCM to the CPP to about April through November of each year. Except for periodic interruptions during extreme winter weather, the operating season is year-round for the mining and overburden stripping operations. Ore is shipped to and stockpiled at the CPP in the months when the rail line is operating.

Itafos controls sufficient surface rights through its leases and agreements with adjacent property owners to conduct all mining operations at RVM and LCM. At H1 and NDR, Itafos is in negotiations with owners of previously mined adjacent properties to conduct mining on those properties and backfill waste into the existing pits there. Water, power and labor required to conduct mining operations are available locally. No tailings are generated or stored at the projects. All overburden rock mined is disposed of in permitted storage areas and as backfill into mined-out pits. No processing is conducted or planned at the projects and no tailings are or are planned to be stored at any project. All RVM and LCM mined ores are loaded at the existing WV Tipple and shipped via an existing UPRR rail line for processing and consumption at the CPP. All tailings storage occurs at the CPP. As currently planned, the H1, NDR and PH projects will also ship mined ores via rail (H1 and NDR) or truck PH to the CPP for processing and tailings storage.

The topography, elevation and vegetation at the projects reflect the mountainous terrain that is typical of southeastern ID. The Itafos Conda projects are located in the Peale Mountains, which consist of several ranges, ridges and intermontane valleys. At RVM and LCM, elevations typically vary from 6,700 feet above mean sea level (AMSL) to nearly 7,600 feet AMSL at local highs, and at H1 and NDR from 7,700 feet AMSL to nearly 8,900 feet AMSL. The topography changes rapidly from the valley floors to the ridge tops and in steeply incised canyons draining higher elevations. PH is located in the foothills of the Bear River Range with topography rising rapidly from about 6,000 feet AMSL in the Bear Lake Valley to the highest elevations on the site of nearly 7,000 feet AMSL. Vegetation is similar at all projects and is primarily sagebrush rangeland at higher elevations with shrubland on ridge flanks and lower elevations. Aspen and mixed aspen conifer forest exists near drainages. Wetlands occur at lower elevations near existing creeks and streams.

History

At the Itafos Conda projects Itafos acquired its leases from Agrium. Agrium and a predecessor had produced relatively small quantities of phosphate ore from LCM. RVM was developed by Agrium and Itafos as a greenfield project. There has been no material historical development or production from the H1 or NDR projects.

Itafos acquired the PH Project with its acquisition on July 18, 2017 of Stonegate Agricom, Ltd. and its wholly owned subsidiary PHA. Phosphate exploration occurred within the PH Project boundary reportedly as early as

1908. Three small-scale underground mines were established in the PH area in 1917 and 1930. Relatively small quantities of ore were produced from these developments, which were each in operation for less than five years.

In the early and mid-1970s, Earth Sciences Inc. (ESI) acquired leases over the project area that included the three early mines and explored for vanadium and phosphate. This work included drilling and sampling and underground development and bulk sampling. In 2007, RMP Resources, Inc. (RMP) acquired the leases from ESI and continued exploration work within the PH area.

In 2009, PHA acquired the ESI leases and leased additional tracts that altogether comprise the current PH Project area. PHA continued significant exploration work and conducted environmental and technical studies that were reported on in the NI 43-101 technical report filed on SEDAR by Stonegate Agricom Ltd. dated July 8, 2013, titled "Amended and Restated NI 43-101 Technical Report, Paris Hills Phosphate Project, Bloomington, ID, USA," with an Effective Date of January 18, 2013. This 2013 Technical Report is no longer current and is replaced by this Report.

Since its acquisition of Stonegate Agricom Ltd., Itafos has continued technical studies at the PH Project. Except for the historical development and production from the small-scale mines, no material mine development or production has occurred at the PH Project.

1.2 Geology and Mineralization

The phosphate mineralization presented in this TR is sedimentary in nature, occurring in a conformable sequence of alternating phosphatic and weakly- to non-phosphatic shale, mudstone, carbonate, and chert beds within the Meade Peak Member of the Permian Phosphoria Formation.

The phosphate mineralization encountered in the Meade Peak Member is stratigraphic in nature and the deposit type is considered a typical example of a marine sedimentary phosphate deposit. The phosphate mineralization occurred during the primary depositional processes and there are no known secondary phases of phosphate mineralization or enrichment identified in the deposits.

The beds of the Meade Peak Member were deposited within a marine sedimentary basin within the Phosphoria Sea that marked the western margin of the North American craton approximately 250 Million years ago. Depositional processes during the period that the Meade Peak Member was being deposited resulted in alternating beds of phosphatic shale and mudstone with layers of non-phosphatic shale, carbonate, and chert beds.

The phosphate mineralization within the Meade Peak Member consists of apatite pellets, oolites, and sand grains, some of which are further cemented together into clusters of pellets and grains in an apatite cement; the apatite within the Meade Peak Member is entirely in the form of carbonate fluorapatite (Altschuler, Z. S. V. , 1958).

Individual beds of the Meade Peak Member are laterally continuous over significant distances, with some beds commonly found distributed over tens of thousands of square miles within the Western Phosphate Field (Sheldon 1989); however, the thickness and geometry of the beds has been locally impacted on a deposit scale by both primary depositional variability as well as post-depositional structural modification due to both regional and deposit scale faulting and folding.

1.3 Exploration Status

Exploration programs described in this TR have taken the stratigraphic nature of the mineralization into account and drill hole spacing, sampling methodology and grade analyses have been designed to evaluate the structural and grade continuity of the targeted phosphatic beds at the deposit scale.

The Itafos Conda projects have primarily been drilled using reverse circulation (RC) drilling methods, supplemented in special cases by a small number of core holes drilled for geotechnical, metallurgical, and other purposes. Drilling has been performed by several different independent drilling contractors over the various campaigns on the four projects.

The PH Project area has been drilled with the use of RC and core drilling; core holes are either drilled to HQ or PQ size. Drilling was contracted to Major Drilling Group International, Inc (Major).

RC chips and drill cores were visually logged by Itafos Conda and PHA geologists for the purpose of collecting downhole lithology, structure, recovery, rock quality designation (RQD) and other geological and physical observations and properties. Wireline geophysical natural gamma logs were performed on most drill holes for the five projects.

Visual descriptive logs and gamma logs were used by the Itafos Conda and PHA geologists to assign beds to the drill hole data for the purpose of identifying sample intervals for grade analyses. Samples from the Itafos Conda projects were submitted for grade analyses at the onsite CPP laboratory, while samples for the PH Project were submitted to a series of independent commercial laboratories. Elements analyzed, analytical procedures, and Quality Assurance/Quality Control (QAQC) measures varied across the exploration campaigns on the individual projects as well as from project to project.

A summary table of drilling data by project is presented in Table 1-1.

Table 1-1: Summary of Available Drilling Data by Project

Project	Total Drill Holes	Drill Holes With Available Data				
		Collar Surveys	Downhole Surveys	Downhole Lithology Records	Raw Assay Data	Geophysical Wireline Logs
RVM	210	210	0	210	198	210
LCM	48	48	2	48	48	46
NDR	253	253	0	253	212	253
H1	235	235	0	235	192	235
SMCM*	66	66	0	66	66	0
PH**	65	65	40	65	45	48

Notes:

* - The South Maybe Canyon Mine is a previously mined adjacent property to the H1 Project. Wireline log data was not available for the 66 drill holes from the South Maybe Canyon Mine (SMCM) area included in the H1 model.

** - Wireline log data was not available for the 11 ESI drill holes included in the PH model nor for 6 of the 9 PHA drill holes that were used for structure modeling only.

Non-drilling exploration data evaluated as part of the current study on the 5 projects included:

- Itafos Conda grade control trench samples and analytical results from RVM and LCM.
- Surface exploration trench samples and analytical results from NDR.
- Surface exploration and adit samples from PH.
- Downhole wireline geophysical logs performed on the majority of the Conda drill holes.
- Surface seismic surveys at PH.
- Regional and deposit scale geological mapping.

It is the Golder QP's opinion that the sample preparation, security, and analytical procedures applied by Conda and its predecessors at the Itafos Conda projects and the PH Project are reasonable for establishing an analytical database for use in grade modeling and estimation of Mineral Resource estimates as summarized in this TR.

The Golder QP has verified the data provided and reviewed, including collar survey, downhole geological data and observations, wireline gamma logs, sampling, analytical, and other test data underlying the information or opinions presented in this TR. The QP, by way of the data verification process described in Item 12, has used only that data that were deemed by the QP to have been: 1) generated with reasonable industry standard procedures; 2) accurately transcribed from the original sources; and 3) suitable to be used for preparing geological models and Mineral Resource estimates. Data that could not be verified by the QP were not used in the development of the geological models or Mineral Resource estimates presented in this TR.

1.4 Development and Operations Status

RVM and LCM Operations

Itafos currently mines phosphate ore at RVM and LCM using open pit mining methods. The open pit mining methods include mine development, phase development and production. The mine development phase includes drainage, water control and primary access. Phase development includes establishing access to the upper benches and removal of topsoil for storage and future reuse. Phase development may only be accomplished during the drier months, so preparation of a new phase is typically done in the year prior it is required for production. The mining excavations generally follow steeply dipping phosphate ore beds, which outcrop along the side slopes of valleys. This results in relatively long and narrow ultimate pits which are subdivided into phases along strike of the deposit. Mining is performed using truck and shovel methods with strict controls to place selenium-bearing material back into previously mined pits. Blasting is limited to the harder limestone. Itafos Conda utilizes dozers with specially designed "wings" that can be extended from the dozer blade to separate the steeply dipping phosphate bed layers to minimize dilution and maximize recovery. Phosphate ore is trucked to the WV Tipple where it is stockpiled by ore type, blended and reclaimed via a tipple for train loading. Itafos Conda has engaged Kiewit Corporation (Kiewit) to perform all mining activities and operation of the WV Tipple.

Itafos Conda currently operates two open pit mining operations; RVM and LCM. LCM is near depletion and will finish production by mid-2020. The first phase of RVM has been developed and is currently supplying ore; all ore will be sourced from RVM when LCM is depleted. Itafos Conda is currently utilizing an adjacent property, Bayer's

previously mined South Rasmussen Mine (SRM) pit for the overburden generated from the opening phase of RVM and backfilling previous phases at the LCM.

Golder has developed a pre-feasibility study (PFS) that includes a life-of-mine plan (LOMP) for LCM and RVM to provide the CPP's annual P₂O₅ requirements from mid-2019 through mid-2026. The LOMP provides approximately 2.2 Million short tons (Mt) of wet ore annually or 2.0 Mt dry ore at an average dry grade of 26.6% P₂O₅ from LCM, RVM, and all existing stockpiles as of July 1, 2019.

The CPP is the exclusive market for the phosphate ores mined and loaded from RVM and LCM, and the CPP plans to continue to take and consume all production from its operating mines and mineral projects as raw feedstock for fertilizer production. Although other chemical plants exist in southeastern Idaho, all of the plant owners are Itafos competitors who also own captive phosphate mines. For this reason, there is no open commodities market in southeastern Idaho for phosphate ores from the Itafos mineral projects.

Environmental conditions at RVM and LCM are imposed through the existing mining permits. An industry-wide condition on SE ID mines is to mitigate the impacts of selenium released from overburden. Current best practices are planned and approved at RVM and LCM, that include primarily transporting selenium-bearing overburden into previously mined pits to prevent discharges. Also, the LOMP for RVM has identified periods where it will be necessary to temporarily store overburden outside the pit boundary. Non-selenium bearing overburden will be stockpiled in designated storage areas, re-handled and placed in the final pit void to comply with regulations.

The RVM and LCM mining operations are vertically integrated cost centers, and state and federal income taxes are not paid directly by nor allocated to the operations.

Based on the PFS, from mid-2019 the expected life of production from LCM is one year and from RVM is through mid-2026. Mine reclamation activities will continue after production ceases at both mines until mine closure.

RVM and LCM are existing operations and outstanding capital investment is primarily working capital, which in the PFS economic analysis is valued at about \$63 Million. Additional investment capital to continue RVM and LCM is estimated to be about \$1.7 Million required in 2021 and 2022. The payback period of working capital and additional capital is less than six years; i.e., by mid-2026.

Development Projects

Future contemplated mining activities include the evaluation and potential development of the H1 and NDR mineral projects as open pit mines and the PH project as a potential underground mine. All tonnage produced from these projects is planned for exclusive supply to the CPP.

H1 and NDR Projects

This report includes the results of a preliminary economic assessment (PEA) of the H1 and NDR mineral resources for delivering potential feedstock for the CPP. The results of the PEA indicate that assuming all permit requirements and development activities are completed by 2025, full production sufficient to meet the requirements of the CPP may occur by 2027 and continue through 2035, and at reduced levels until the end of 2037. Initial capital in 2019\$ is estimated to be about \$104 million with \$72 million in new facilities and development and \$32 million working capital. The imputed average transfer price required to recover all costs of production FOB WV Tipple plus a margin sufficient to yield a 12% pre-tax internal rate of return on all production and cover post-production final reclamation and closure costs is estimated to be \$222 per ton of P₂O₅ delivered. During full production years, the imputed transfer price per year varies from \$209/ton P₂O₅ to \$229/ton of P₂O₅

depending on production costs. Note that all tons reported in this Technical Report are in short tons unless stated otherwise. The imputed transfer prices estimated over the PEA period are well within the forecast GMAs from CPP fertilizer sales over the same period; therefore, indicating positive potential economics for CPP supply from the H1 and NDR phosphate mineral resources.

PH Project

The PH Project is considered to have reasonable potential for future underground mining operations. Originally conceived by Stonegate Agricom Ltd. as a potential supplier of washed phosphate rock to domestic and foreign commodity markets, Itafos is evaluating the project as a potential longer-term captive supply source to the CPP. This report presents current Mineral Resource estimates for the PH Project.

1.5 Mineral Resource and Mineral Reserve Estimates

Mineral Resource Estimate

The Mineral Resource estimates presented in this report were prepared under the supervision of Golder's QP in accordance with the definitions presented in NI 43-101 and the CIM Definition Standards. The estimates were based on geological and grade block models generated from all verified exploration and pre-production drill holes and analytical samples drilled by the Company to date for the five properties.

Data verification was performed under the supervision of the Golder QP while exploration data collection was performed under the supervision of Company personnel that also met the standard for QPs under the applicable definitions.

The Golder QP used the verified exploration and sample data to construct a computer-based geological block model of the in-situ phosphate deposit and surrounding rocks and a P₂O₅ grade model for each of the five projects. The geological models for the five projects were based on a structural interpretation of the deposits based on drilling intervals through the deposits and in the case of RVM and LCM, actual geological exposures in the pits. The grade models consisted of estimated grades within each geological block identified as in situ phosphate. The block model grades were interpolated from sample values of drill hole intercepts.

The Mineral Resources presented in this TR have been estimated by applying a series of physical and geological limits as well as high-level mining and economic constraints; the mining and economic constraints were limited only to a level sufficient to support reasonable prospects for future economic extraction of the estimated resources.

The Mineral Resource categorization applied by Golder has included the consideration of data reliability, spatial distribution, abundance of data, continuity of geology, and grade parameters. Golder performed a statistical and geostatistical analysis for evaluating the confidence of continuity of the geological units and grade parameters. The results of this analysis were applied to developing the Mineral Resource categorization criteria.

The categorized estimated Mineral Resources for RVM, LCM, NDR, H1, and PH are presented in Table 1-2. Mineral Resource categorization of Measured, Indicated, and Inferred Mineral Resources presented in Table 1-2 is in accordance with the CIM definition standards (CIMDS, 2014). The Effective Date of the Mineral Resource Estimate is July 1, 2019.

Although the Mineral Resources presented in this TR are believed to have a reasonable expectation of being extracted economically, they are not Mineral Reserves. Estimation of Mineral Reserves requires the application of

modifying factors and a minimum of a PFS. The modifying factors include, but are not restricted to, mining, processing, metallurgical, infrastructure, economic, marketing, legal, environmental, social, and governmental factors. To date, except as described in Item 15 of this report, studies that provide further insight into prospects for development and extraction of the Mineral Resources have not been completed to a minimum of a PFS

With respect to RVM and LCM, for which Mineral Reserves are reported in Item 16 of this TR, the Mineral Resources are inclusive of Mineral Reserves.

The Mineral Resources presented in this TR for H1 and NDR for which a PEA is presented in Item 24 of this TR, are not Mineral Reserves and do not reflect demonstrated economic viability.

For all projects, the reported Inferred Mineral Resources are considered too speculative geologically to have the economic considerations applied to them that would enable them to be categorized as Mineral Reserves.

There is no certainty that all or any part of this Mineral Resource will be converted into Mineral Reserve.

Table 1-2: Summary of Estimated Mineral Resources – Effective Date July 1, 2019

Project	Zone	Resource Classification	Volume (millions; bcf)	Short Tons (Millions, dry)	P ₂ O ₅ (wt.%)	MgO (wt.%)	Fe ₂ O ₃ (wt.%)	Al ₂ O ₃ (wt.%)
RVM	UPZ & LPZ Combined	Measured	197.5	13.0	26.6	0.90	0.86	2.33
		Indicated	27.0	2.0	26.2	0.63	0.90	2.46
		Inferred	2.5	0.2	25.7	0.59	0.92	2.48
LCM	UPZ & LPZ Combined	Measured	14.0	1.0	27.5	0.90	0.80	1.34
		Indicated	6.5	0.5	28.2	0.98	0.76	1.62
		Inferred	0.5	0.0	27.5	1.15	0.66	1.56
NDR	UPZ & LPZ Combined	Measured	95.0	6.5	26.9	0.82	-	2.38
		Indicated	19.0	1.5	27.0	0.91	-	2.32
		Inferred	2.0	0.1	26.8	0.94	-	2.39
H1	UPZ & LPZ Combined	Measured	314.5	21.0	24.3	0.98	0.82	2.09
		Indicated	128.0	8.5	24.7	0.98	0.84	2.13
		Inferred	10.5	0.5	24.3	0.89	0.82	2.04
PH	UPZ	Measured	320.5	26.0	22.9	0.89	0.80	1.15
		Indicated	492.0	40.0	22.3	0.86	0.81	1.06
		Inferred	93.0	7.5	22.0	0.89	0.75	0.99
	LPZ	Measured	157.5	13.0	30.9	0.26	0.51	1.02
		Indicated	223.5	18.0	29.5	0.59	0.49	0.81
		Inferred	49.0	4.0	30.1	0.63	0.46	0.77
Totals	UPZ & LPZ Combined	Measured	1,099.0	80.5	25.5	0.81	0.70	1.67
		Indicated	896.0	70.5	24.6	0.80	0.72	1.19
		Inferred	157.5	12.3	24.8	0.80	0.65	1.00

Notes:

1. RVM = Rasmussen Valley Mine; LCM = Lanes Creek Mine; NDR = North Dry Ridge Project; H1 = Husky 1 Project; PH = Paris Hills Project; UPZ = Upper Phosphate Zone; LPZ = Lower Phosphate Zone; bcf = bank cubic feet; wt.% = weight percent.
2. Mineral Resource categorization of Measured, Indicated and Inferred Mineral Resources presented in the summary table is in accordance with the CIM definition standards (CIMDS, 2014).
3. The Mineral Resources presented are reported on a dry in-situ basis. Masses for the four Itafos Conda projects have been converted from wet to dry basis using a 10% moisture factor. The PH Project masses were estimated in dry basis.
4. No recovery, dilution or other similar mining parameters have been applied.
5. Although the Mineral Resources presented in this TR are believed to have a reasonable expectation of being extracted economically, they are not Mineral Reserves. Estimation of Mineral Reserves requires the application of modifying factors and a minimum of a PFS. The modifying factors include, but are not restricted to, mining, processing, metallurgical, infrastructure, economic, marketing, legal, environmental, social, and governmental factors. To date, except as described in Item 15 of this report, studies that provide further insight into prospects for development and extraction of the Mineral Resources have not been completed to a minimum of a PFS.
6. With respect to RVM and LCM, for which Mineral Reserves are reported in Item 16 of this TR, the Mineral Resources are inclusive of Mineral Reserves.
7. The Mineral Resources presented in this TR for H1 and NDR for which a PEA is presented in Item 24 of this TR, are not Mineral Reserves and do not reflect demonstrated economic viability.
8. For all projects, the reported Inferred Mineral Resources are considered too speculative geologically to have the economic considerations applied to them that would enable them to be categorized as Mineral Reserves.
9. There is no certainty that all or any part of this Mineral Resource will be converted into Mineral Reserve.
10. Mineral Resource estimates are not precise calculations, being dependent on the interpretation of limited information on the location, shape and continuity of the occurrence and on the available sampling results. All figures are rounded to reflect the relative accuracy of the estimates.
11. The Mineral Resource estimates for the potentially surface mineable resources (RVM, LCM, NDR, and H1) were constrained by conceptual pit shells for the purpose of establishing reasonable prospects of eventual economic extraction based on potential mining, metallurgical and processing grade parameters identified by studies performed to date on the Project.
12. The Mineral Resource estimates for the potentially underground mineable resources at PH were constrained by property boundaries on north, south and east sides as well as depth, water and high-level economic considerations. A vertical limb on the west side of the property would require an alternative mining method and to date has not been drilled to the extent to support an estimate of geologic resources.
13. Key constraint inputs included reasonable assumptions for operating costs, CRU fertilizer product forecast prices and a 20% minimum P₂O₅ grade for the four Itafos Conda projects and the UPZ mineralization at the PH Project, based on current CPP specifications for all estimated resources except for the LPZ mineralization at PH. The LPZ at PH was defined using a 24% minimum P₂O₅ grade to allow for a head-grade of 30% P₂O₅, which is amenable to direct-shipping without the need for beneficiation.

Mineral Reserve Estimate

Golder produced a PFS for the remaining life of the RVM and LCM. The PFS included a LOMP including mine designs and mining sequences and annual estimates of waste and ore production based on Measured and Indicated Mineral Resource estimates for RVM and LCM. In determining annual production, the QP applied reasonable Modifying Factors of mining loss and dilution. Any Inferred Resources encountered in the sequencing were treated as overburden material. The mining sequence in LCM is scheduled to be completed by mid-2020 and the continued mining of RVM is scheduled to provide ore through the end of 2025. An existing stockpile inventory of 1.4 Mt dry was included in the economic analysis and Mineral Reserve estimates. Stockpile inventory varies as Itafos Conda typically does not ship ore from November through March. The mining schedule turns over the current stockpile early in the mining schedule but maintains the stockpile in a manner consistent with past practice.

The annual production estimates were used to determine annual estimates of operating and capital costs. All cost estimates were in real 2019\$ terms. Total capital costs were as described previously and consisted of working capital of about \$63 million in primarily stockpile inventory plus sustaining capital of about \$1.7 million. The annual operating cost estimates in the PFS also included annual estimates of concurrent and post-production or final reclamation costs until projected mine closure. The cost estimates were based on actual Itafos costs and mining contractor rates under an existing mine contracting services agreement with a nationally recognized mining contractor. The QP considers the cost estimates to be to a PFS standard and sufficient for an economic analysis required to support Mineral Reserve estimates for RVM and LCM.

For the economic analysis, a discounted cash flow (DCF) model was developed for the PFS. Because RVM and LCM are captive suppliers to the CPP, and there is no transparent mined phosphate rock commodities price market in southeastern Idaho, in the PFS Golder estimated mineral reserves for RCM and LCM based on an imputed transfer price for the LOMP phosphate ore produced and loaded at the WV Tipple. The annual transfer prices are equal to the estimated cost of production and loading from the RVM/LCM PFS plus a pre-income tax margin sufficient to return all capital invested, provide an Internal Rate of Return (IRR) of 7% on all capital invested and cover all costs of final reclamation after production ceases. The resulting transfer prices from the DCF model vary during full production years over the PFS period from \$173 to \$185/ton of P₂O₅ delivered FOB WV Tipple in real 2019\$ terms.

To determine whether the imputed transfer prices from the DCF analysis were economic, Golder estimated the CPP Gross Margins Available FOB WV Tipple (GMA) based on forecast MAP and SPA production provided by Itafos, and fertilizer product prices and estimated chemical plant costs stated in an independent 2019 market study commissioned by Itafos. The price forecasts were for MAP net-back to the CPP and Itafos SPA realized prices at the CPP for the years 2019 through 2045 in real 2019\$ terms. Golder estimated the future annual GMAs to pay the imputed transfer prices as follows:

$$\text{Gross Margin Available FOB WV Tipple (GMA)} = (\text{Revenue} - \text{CPP Plant Cost} - \text{Rail Cost}) / \text{P}_2\text{O}_5 \text{ dry tons required by the CPP.}$$

The CPP Plant Cost includes washing costs. Ore washing and rail costs were based on actual costs provided by Itafos. The resulting GMAs estimated in real 2019\$ terms were \$269/ton of P₂O₅ delivered FOB WV Tipple in 2019 increasing to \$418/ton of P₂O₅ delivered FOB WV Tipple in 2025 because of forecast increases in MAP and SPA fertilizer prices realized at the CPP. Because the estimated annual GMAs exceed the annual imputed

transfer prices of the RVM/LCM ores delivered under the PFS, the forecast production plan is economically viable, and therefore, the PFS results in the Mineral Reserve estimates shown on Table 1-3.

Table 1-3: Summary of Estimated Mineral Reserves by Mine and Classification – Effective Date July 1, 2019

Deposit	Classification	Ore (Mt – dry) ^{ab}	P ₂ O ₅ (% wt) ^c	Waste (MBcy) ^d	Strip Ratio (MBcy:Mt)
Rasmussen Valley (RVM) ^e	Probable	0.9	26.6	n/a	
	Proven	11.2	26.6	n/a	
	Total RVM	12.2	26.6	50	4.1
Lanes Creek (LCM) ^f	Probable	0.3	28.8	n/a	
	Proven	0.5	28.0	n/a	
	Total LCM	0.8	28.3	1.9	2.4
Total RVM+LCM	Probable	1.2	27.1	n/a	
	Proven	11.7	26.7	n/a	
	Total RVM+LCM	13	26.7	51.9	4.0
Stockpiles ^g	Proven	1.4	25.9	n/a	
Total Reserves ^f	Probable+Probable Reserves	14.4	26.6	n/a	

Notes:

n/a = not applicable.

- A moisture content of 10% was assumed to convert from wet short tons to dry short tons
- A 97% mining recovery and 0% dilution was applied to the tons selected as ore.
- A P₂O₅ cutoff grade of 20% was assigned as the minimum required grade to be considered ore.
- All blocks that are not selected as ore, including blocks classified as Inferred were considered as overburden.
- A pit optimization analysis was performed on the RVM deposit, which incorporated the geotechnical parameters, mining costs of \$3.83/t wet overburden, \$7.27/t wet ore, ore stockpiling and tipple costs of \$1.32/t wet and royalties that varied with grade and averaged approximately \$1.70/t wet. A Gross Margin available per mined P₂O₅ ton (applied at the point of exchange at the tipple) of \$271/dry ton was used to define the limits of the mining pits.
- A pit optimization analysis was performed on the LCM deposit, which incorporated the geotechnical parameters, mining costs of \$4.56/t wet overburden, \$11.34/t wet ore (including royalty), ore stockpiling and tipple costs of \$1.32/t wet. A Gross Margin available per mined P₂O₅ ton (applied at the point of exchange at the tipple) of \$271/dry ton was used to define the limits of the mining pits.
- All stockpiles which include LCM ex-pit, WV Tipple, and Plant stockpiles, total dry tons and average P₂O₅ grades are displayed.

The Proven and Probable Reserve estimates shown in Table 1-3 result from the conversion of Measured and Indicated Mineral Resources, respectively.

The extent to which the Mineral Reserve estimates could be materially affected by mining, metallurgical, infrastructure, permitting, and other relevant factors that are different than the factors used in the PFS and described in this report is shown by the sensitivity analysis provided in Item 22. Because RVM and LCM are producing mines, infrastructure and permitting factors are not anticipated to materially affect the Mineral Reserve estimate.

Except for the CPP GMAs, which are dependent primarily upon fertilizer prices and chemical plant costs, all other relevant mining and metallurgical factors related to RVM and LCM and described in this report are factors affecting the estimated operating costs summarized in Item 21 of this report. If for any reason any of these operating cost factors are changed such that operating cost estimates change materially, then the Mineral Reserve estimates stated in this report could be materially affected. However, as an example, if the cost factors are changed such that total operating and capital cost estimates are increased by 25%, the imputed transfer price in 2019 increases from \$163/ton to \$201/ton of P₂O₅ delivered FOB WV Tipple or about 23%. This imputed price remains below the 2019 GMA of \$269/ton as described in Item 19 and therefore the Mineral Reserve estimates

may remain unaffected. As of the effective date, there are no known cost factors that are materially different from the factors used in the PFS and summarized in this report to the extent that the Mineral Reserve estimates would be materially affected.

Revenues projected in the PFS economic analysis summarized in Item 22 depend upon forecast MAP net-back CPP and Itafos realized SPA prices that are used to calculate the GMAs described in this report. If the forecast prices of the CPP phosphate products over the study period decline by 25% or more, then the Mineral Reserve estimates will be materially and adversely affected. In this case, the GMA would be reduced to about \$135/ton of P₂O₅ delivered FOB WV Tipple, and the extent to which the Mineral Reserve estimates could be affected is estimated to be about a 35% to 45% reduction based upon the pit shell analysis described in this report.

1.6 QP's Conclusions and Recommendations

Geology and Mineral Resource Estimation Recommendations

Regarding geology and Mineral Resource estimation, recommendations include the following:

- Update the H1 and NDR Project models with data from the 2019 metallurgical drilling program once results are available.
- Evaluate additional drilling needs with consideration towards additional quality control/verification purposes for areas reliant on older vintage drilling such as NDR (legacy drilling from 1989 and 1990) and the South Maybe Canyon drilling (legacy drilling performed on behalf of and results supplied by a competitor) at the north end of the H1 Project. Additional drilling at NDR should also target collecting core to perform project specific metallurgical test work. See below for a high-level cost estimate for recommended drilling.
- Evaluate additional drilling opportunities to expand resource inventory along strike and down dip (at depth) of the current delineated resources.
- As part of any future exploration work, it is recommended to perform additional external check assays for Itafos Conda projects analytical data performed primarily at CPP.
- As part of future exploration work perform downhole positional surveys on drill holes at Itafos Conda projects.
- Perform additional density and moisture data for all projects to develop more robust default values.
- Acquire improved topographic data to develop new topographic models for NDR and H1.
- Perform evaluation of potential for mineralization within the overturned limb at PH.
- Perform evaluation of the potential vanadium zone at PH.

As stated above, Golder recommends additional drilling at H1 and NDR as follows:

- H1 Drilling Recommendations:
 - Approximately ten core drill holes twining historical SMCM drilling conducted by operators other than Conda and its predecessors. The purpose of this program is to evaluate the reliability and representativeness of the historical SMC drilling used in the north end of the H1 model.
 - Depending on the results of the 2019 H1 drilling program, there may be further opportunities for both resource expansion and infill drilling to upgrade resource classification, especially in the southern part of H1 where the structure is more complex. Based on initial evaluations this additional drilling could include up to 40 drill holes.
 - All proposed drilling should include a robust analytical QA/QC program of standards, blanks and duplicate/replicate analyses. Drill collars should be surveyed by the Itafos Conda mine surveying department or a professional surveyor and downhole directional surveying should be considered.
 - Estimated cost for the ten core drill holes in the SMCM area is approximately \$1.5 M. Estimated cost for drilling up to 40 drill holes for resource expansion and infill drilling in the H1 Project, pending evaluation of results of the 2019 program, is approximately \$6 M.
- NDR Drilling Recommendations:
 - Approximately ten core drill holes spatially distributed across the NDR Project. The purpose of this program is to evaluate the reliability and representativeness of the 1989 and 1990 Conda drilling as well as to collect project specific metallurgical data for further studies and estimates.
 - All proposed drilling should include a robust analytical QA/QC program of standards, blanks and duplicate/replicate analyses. Drill collars should be surveyed by the Itafos Conda mine surveying department or a professional surveyor and downhole directional surveying should be considered.
 - Estimated cost for these five core drill holes is approximately \$1.5 M.

Mining

- Prepare a PFS level study on the H1 and NDR projects once the metallurgical information becomes available.
- Evaluate the potential for lowering the cutoff grade and increasing reserves.
- Develop and perform additional reconciliation studies as mining progresses in RVM and incorporate the results into future mining studies.

Metallurgy Recommendations

In regard to metallurgy, recommendations include the following:

- Characterization studies on RVM, LCM, H1, and NDR representative samples of each project are necessary. These studies should include beside the regular chemical analyses; screen assays, mineralogical, and QEMSCAN studies. These last studies should concentrate on dolomite and carbonate minerals with special detail on their morphology, primary particles size, and crystal structure.
- Optimization studies on horizontal scrubbing should be carried out not only taking into consideration particle-particle interactions, but also rheological behavior. The purpose should be to maximize dolomite and fine silica rejection.
- Crushing of the +1.375-inch material (+34,925 μm) should be revisited. Apparently, the use of bed-comminution mechanism instead of impact mode should be explored to take advantage of selective comminution of dolomite.
- Attrition scrubbing and optimization studies of this unit operation on the -0.375-inch size fraction (-9,525 μm) should be conducted to determine if rejection of dolomite and SiO_2 may be sufficient using attrition scrubbing to upgrade the washed product to specs (>30% P_2O_5 and < 0.60% MgO).
- Improve process control for the Wash Plant should be considered. For example, it could include moisture determination (using microwaves or infrared) with the weight meters for both the phosphate feed and the washed product, continuously measuring dry Tons. In addition, solids content or density meters of the tailings stream (overflow of the Krebs gMax-20 hydrocyclones) should be considered in conjunction with chemical analysis to determine tailings P_2O_5 losses. This tailings controls should be complemented with pump flowmeters.
- Develop the adequate procedure for the flotation feed preparation based on optimized results of the horizontal scrubbing, crushing, and attrition scrubbing studies. For this purpose, sizing must be investigated at the corresponding cutting meshes, as determined by the characterization studies, before and after classification at 325 mesh (44 μm). Thus, the actual size fraction to be submitted to flotation could be determined.
- If flotation is required, grinding of the 0.375 inch x 48-mesh size fraction (9525x300 μm) to minus 48 mesh (-300 μm) must be studied to define the grinding parameters and best operating conditions.
- Flotation studies at the required size fraction should be carried out. These studies should include reagents types and dosages necessary, pH, solids content, conditioning techniques, and flotation cell types and operating conditions.
- Pilot plant tests for H1 and NDR Phosphate Ores must be considered once the final flowsheet is determined.

2.0 INTRODUCTION

2.1 Itafos

Itafos is the issuer for whom this technical report was prepared and is a vertically integrated phosphate fertilizers and specialty products company incorporated in the Cayman Islands and publicly traded on the TSX-V: IFOS. Itafos owns Itafos Conda which owns the CPP located near Soda Springs, ID. See Figure 2-1, Property Location Map.

The CPP includes a chemical plant that encompasses integrated phosphate fertilizer and industrial product manufacturing operations. The CPP has a production and sales capacity of approximately 550 kt per year of monoammonium phosphate (“MAP”), MAP with micronutrients (MAP+), superphosphoric acid (SPA), merchant grade phosphoric acid (“MGA”) and specialty products including ammonium polyphosphate “APP). The CPP also includes a wash plant and ball mill that beneficiates mined phosphate ore delivered by rail to produce the phosphate rock feedstock required by the chemical plant.

Itafos engaged Golder to compile this National Instrument (NI) 43-101 Technical Report on mineral projects in operation or under development in southeastern ID, USA, and owned by its wholly owned subsidiaries, Itafos Conda LLC (Itafos Conda) and Paris Hills Agricom Inc. (PHA). All phosphate ore mined currently or developed in the future from these projects will be transported to the CPP to be processed into saleable fertilizer products.

Itafos Conda operates the RVM and the LCM and is developing the nearby H1 t and NDR projects. See Figure 2-1 for the location of the projects relative to the CPP. The projects are active or proposed surface mines that will share substantial infrastructure. Mined phosphate ore is and will continue to be delivered from these mines and projects to rail loadouts and transported via the Union Pacific Railroad (UPRR) to the CPP.

PHA is conducting further studies at the PH Project, which is located near Bloomington, ID. See Figure 2-1 for its location. PH is being studied as a potential long-term future source of underground mined phosphate ore to the CPP.

Terms of Reference

Itafos engaged Golder to compile this Technical Report to disclose all material scientific and technical information on the Itafos Conda and PH projects. For the purposes of the report, the Property consists of the four Itafos Conda projects and the PH Project. This report is a summary of the following studies:

- Mineral Resources and Mineral Reserves estimates for the currently operating RVM and LCM.
- A Mineral Resources estimate and a Preliminary Economic Assessment (PEA) of the H1 and NDR projects.
- A Mineral Resources estimate for the PH Project.

Except where stated differently, this report uses U.S. Customary Units for weights and measures. Currency values are in United States Dollars (\$). All prices are in real 2019 dollars.

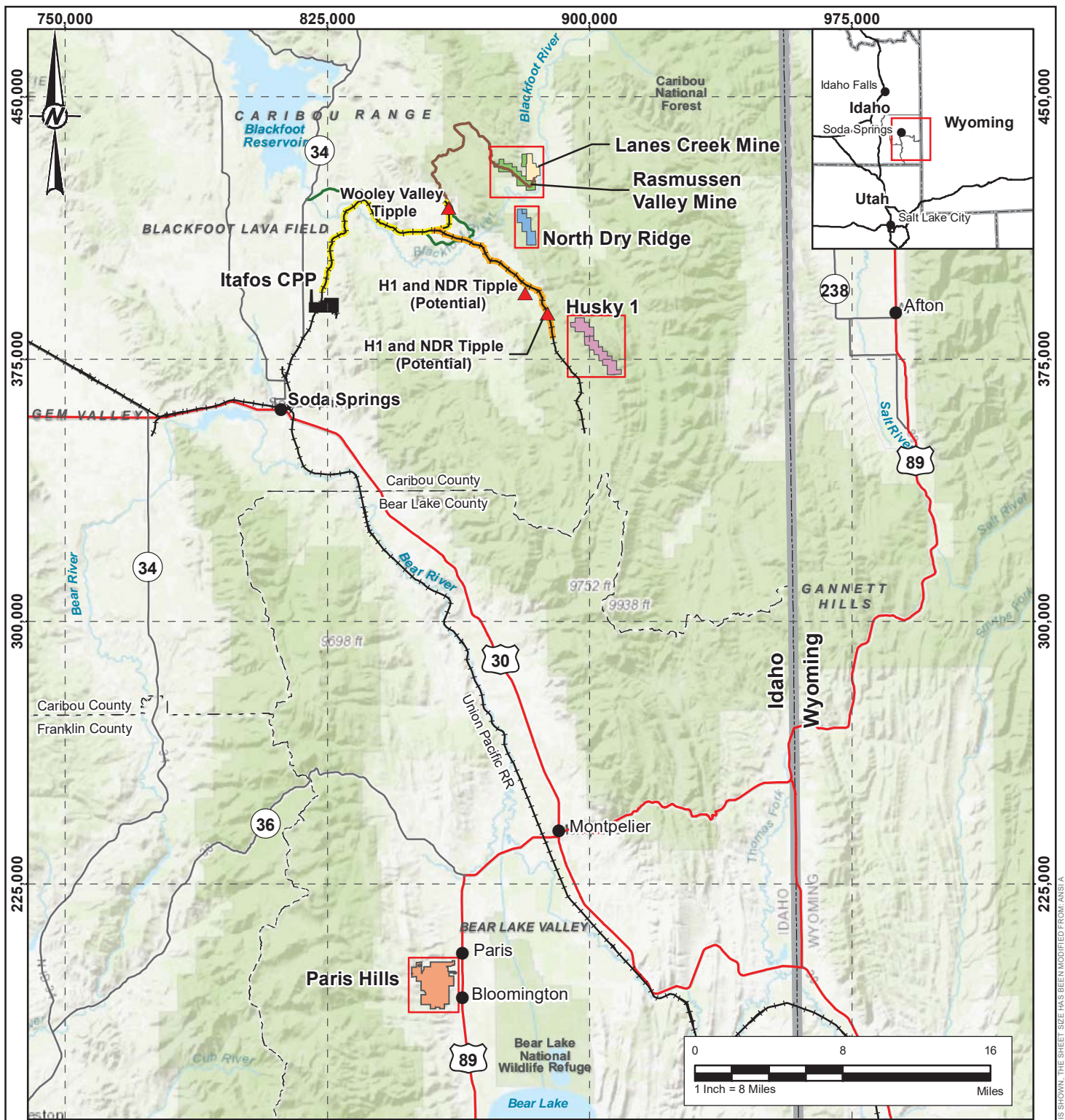

LEGEND

- Project Map Extents
- State Boundary
- County Boundary
- U.S. Highway
- State Highway
- Public Vehicle Access
- Haul Road
- Railroad
- Railroad - Existing
- Railroad - Existing to be Refurbished
- Itafos CPP
- ▲ Tipple

REFERENCE(S)

1. COORDINATE SYSTEM: NAD 1983 STATE PLANE IDAHO EAST FIPS 1101 FEET
2. DATA PROVIDED BY ITAFOS CONDA LLC

CLIENT

ITAFOS CONDA LLC

PROJECT

NI 43-101 TECHNICAL REPORT FOR CONDA PHOSPHATE OPERATIONS

TITLE

PROPERTY AND PROJECTS LOCATION AND INDEX MAP

CONSULTANT



YYYY-MM-DD 2019-12-06

DESIGNED -

PREPARED EFT

REVIEWED MO/RM

APPROVED TM

PROJECT NO.
18114499

CONTROL
0001

REV.
-

FIGURE
2-1

1 in IF THIS MEASUREMENT DOES NOT MATCH WHAT IS SHOWN, THE SHEET SIZE HAS BEEN MODIFIED FROM: ANS/A

This Technical Report is prepared in accordance with NI 43-101 and the format required by Form F1 of the Instrument. The Mineral Resource and Mineral Reserve estimates are stated per the definitions and guidance provided in The CIM Definition Standards on Mineral Resources and Reserves (CIMDS), adopted May 10, 2014.

2.2 Sources of Information

The sources of information and data contained in the technical report or used in its preparation are as follows. Itafos personnel supplied all scientific and technical information and data related to the Itafos Conda and PH projects that was used to prepare this report. As described in this report, Golder QPs reviewed and verified the information and data provided, and used the data to produce geological models, resource and reserve estimates, cost estimates, and economic analyses to prepare this report. Itafos also engaged CRU Group to prepare a market study, market price forecasts of fertilizer products from the CPP, and to estimate costs of the chemical plant in 2019 and 2025, all in real 2019\$ terms. Applicable citations to specific studies and references are provided in Item 27 of this Technical Report.

2.3 Personal Inspection Details

Table 2-1 provides the details of the personal inspection on the Property by each QP.

Table 2-1: Site Visit Details

Qualified Person	Date	Locations Inspected	Activities Inspected
Edward Minnes	9/29/2019 – 10/10/2019	H1 and NDR Areas	Access and PEA areas.
Edward Minnes	4/15/2019 – 4/18/2019	RVM, LCM, CPP, and PH	Itafos Conda Mining operations. PH visit to office/archives, core storage and proposed mine site.
Jerry DeWolfe	9/16/2019 – 9/18/2019	H1 and NDR Areas	Drilling, logging & sampling for metallurgical bulk sample program.
Jerry DeWolfe	4/15/2019 – 4/18/2019	RVM, LCM, CPP and PH	Itafos Conda Mining operations, core storage and logging procedures, CPP analytical laboratory, modeling procedures. PH visit to office/archives, core storage and proposed mine site.
Dr. Francisco J. Sotillo	6/18/2019	Wash Plant, Plant Ore Stockpiles, Tailings Facility and Lab	Wash Plant, plant ore stockpiles, tailings pond and analytical laboratory operations.
Mitchell J. Hart	Employed at Conda from 12/2007 to 4/2016 Recent visits include: 3/11/2019 3/11/2019 4/18/19	All facilities at Conda and PH. RVM LCM PH	 Site visit – observed mine operations and trench sampling Drive-by site visit Paris, ID – visit to office/archives, core storage and proposed mine site.

3.0 RELIANCE ON OTHER EXPERTS

In this Technical Report and as described in this Item, the qualified persons relied on: a) a report, opinion, statement of another expert who is not a qualified person, or on information provided by the issuer concerning legal, political, environmental, or tax matters relevant to the technical report; or b) a report, opinion, or statement of another expert who is not a qualified person concerning the pricing of commodities for which pricing is not publicly available.

3.1 Legal, Political, Environmental, or Tax Matters

Table 3-1 identifies reliance by the qualified persons concerning legal, political, environmental, or tax matters relevant to the Technical Report. To the extent of each QP's reliance, the QP disclaims responsibility for the information relied upon.

Table 3-1: Sources of Information

Qualified Person	The source of the information relied upon, including the date, title, and author of any report, opinion, or statement	The Extent of Reliance	The Portions of the Technical Report to which the Disclaimer Applies
Jerry DeWolfe, P.Geo.	Itafos	Total reliance on: <ol style="list-style-type: none"> a) Legal matters related to statements on Itafos mineral control, surface rights and use agreements at all of the projects including associated royalties and costs. b) Political matters regarding statements describing Itafos' relationships with local communities. c) Environmental matters related to statements on permits and compliance, permit requirements and status of permit applications, bonding, and any agreements with any regulatory agency. d) Tax matters related statements regarding any form of tax cost or lack thereof. 	Item 1 – Summary of information relied upon. Item 4 – All parts. Item 5 – Sufficiency of surface rights and local resources. Item 6 – History of Property ownership changes. Item 14 – Assumptions on these matters relevant to mineral resource estimates. Item 23 – Adjacent Properties. Item 25 – Interpretation and Conclusions based on information relied upon. Item 26 – Recommendations based on information relied upon.
Edward Minnes, P.E.	Itafos	Total reliance on: <ol style="list-style-type: none"> a) Legal matters related to statements on Itafos mineral control, surface rights and use agreements at all of the projects including associated royalties and costs. b) Political matters regarding statements describing Itafos' relationships with local communities. c) Environmental matters related to statements on permits and compliance, permit requirements and status of permit applications, bonding, and any agreements with any regulatory agency. d) Tax matters related statements regarding any form of tax cost or lack thereof. 	Item 1 – Summary of information relied upon. Item 4 – All parts. Item 5 – Sufficiency of surface rights and local resources. Item 6 – History of Property ownership changes. Item 15 – Assumptions on these matters relevant to mineral reserve estimates. Item 18 – Assumptions on these matters relevant to surface and infrastructure use required for each project. Item 21 – Assumptions on these matters relevant to cost estimates. Item 22 - Assumptions on these matters relevant to cost and cashflow estimates. Item 25 – Interpretation and Conclusions based on information relied upon. Item 26 – Recommendations based on information relied upon.

3.2 Fertilizer Markets and Phosphate Rock Pricing

In this Technical Report, QP Jerry DeWolfe and QP Edward Minnes relied on a report, opinion, or statement of another expert who is not a qualified person concerning the pricing of fertilizer products produced from the CPP. Such pricing is used to determine the economics of the phosphate ore produced, or to be produced, from the mineral projects for which pricing is not publicly available. Prices for phosphate ore or marketable phosphate rock beneficiated from the ore are not publicly available because Itafos is a vertically integrated phosphate fertilizers and specialty products company that uses mined and beneficiated phosphate rock as feedstock for its ultimate saleable fertilizer products. All other phosphate rock produced in the U.S. is used by similar vertically integrated fertilizer and phosphorous producers and for this reason there are no publicly available commodity price indices for phosphate ore or phosphate rock sold in the southeastern ID region.

Jerry DeWolfe and Edward Minnes entirely relied upon, and disclaim responsibility for the fertilizer market analysis, MAP and SPA price forecasts, and product transportation and chemical plant costs described in Item 19.0. The forecasts and estimates in Item 19.0 were relied upon and are material to:

- 1) The mineral resource estimates in Item 14, because the forecast sales prices and chemical plant cost estimates are the basis of potential revenues available for the reasonable prospects of economic extraction of phosphate analysis applied to each mineral project.
- 2) The economic analysis in Item 22 and the mineral reserve estimates in Item 15, because the margin between the sales price forecasts and chemical plant cost estimates are relied upon to ensure that adequate funds are projected to be available to mine phosphate ore and load it onto rail cars for transport to the CPP from the mineral projects.
- 3) The Item 1 Summary and Items 25 and 26 Conclusions and Recommendations from and in reliance upon Items 19, 14, 22, and 15.

Itafos retained CRU Consulting, a company that provides market analysis on metals and fertilizers, to prepare a report providing a forecast of phosphate market prices that are key to Conda's market region. The report by a non-QP that is relied upon is the CRU Phosphate Study, dated 2 August 2019 (CRU Ref. ST1916-19) by CRU Consulting, which is part of CRU International Ltd. of London, U.K (CRU, 2019).

CRU Consulting is the independent consulting and advisory arm of the CRU Group, an international business intelligence firm. Founded in 1969, CRU employs over 280 experts and has more than 11 offices around the world, in Europe, the Americas, China, Asia, and Australia. CRU delivers independent market analysis on a comprehensive range of global commodities across mining, metals and fertilizers. CRU produces in-depth market analysis and forecasts – where commodities meet economics to provide clients with reliable and authoritative views. CRU's cost services help users gain an understanding of industry cost structures, to rank facilities against each other, investigate investment opportunities, and conduct accurate strategic planning.

It is reasonable for QP Jerry DeWolfe and QP Edward Minnes to have relied on the CRU Study and the non-qualified persons who prepared it because CRU, its consultants, and analysts are widely known as experts in commodity price forecasting as well as metals, minerals, and fertilizer industry analyses. CRU's "Fertilizer Week" industry monitor is a widely read industry publication reporting global fertilizer prices assessed weekly across all nutrients and major fertilizer products and supported by analysis and market-moving news.

Significant risks associated with the forecast pricing are discussed in Item 19.0.

QP Jerry DeWolfe and QP Edward Minnes took the following steps to verify the information provided. The QPs use public research available online to verify current and historical fertilizer prices as well as information provided by Itafos regarding existing production costs and escalation drivers.

4.0 PROPERTY DESCRIPTION AND LOCATION

4.1 Locations and Areas

Through its subsidiaries of Itafos Conda and PHA, Itafos controls mineral rights on ±14,371 acres principally in Caribou and Bear Lake Counties of Idaho. The Itafos Conda mines and projects are located about 15 miles east/northeast of the town of Soda Springs, Idaho, and the Paris Hills Project is adjacent to and west of the town of Bloomington, Idaho, which is about 50 miles by state highway south of Soda Springs. See Figure 2-1, Property Location Map.

The Property consists of the four active Itafos Conda projects with a total area of ±2,840 acres, and the PH Project with an area of ±2,500 acres. The areas and locations of the Itafos Conda and Paris Hills projects are summarized in Table 4-1. An additional ±9,031 acres under lease is controlled by Itafos Conda as Exploration Targets (see Item 24.3 and designated as Other Leases in Table 4-1. Itafos Conda owns an additional 5,837 acres within Caribou County. These other properties are associated with the CPP, the WV Tipple and various other properties that have been acquired. There is no phosphate ore associated with these properties.

Table 4-1: Location and Acreage: Itafos Conda and Paris Hills Projects

Project	Area (Acres)	Surface Estate Owner	Itafos Control Mechanism	County	Location Township, Range and Section
LCM	475	Private	Lease	Caribou	T7S R44E, Sec. 4, 9 T6S R44E Sec. 32
RVM	820	Mixed (Federal, State and Private)	Lease/Own	Caribou	T7S R44E Sec. 4, 5, 6, 8, 9 T6S R44E Sec. 31, Sec. 32
H1	865	Federal	Lease	Caribou	T8S R45E Sec. 30, 31, 32 T8S R44E Sec. 24, 25
NDR	680	Mixed (Federal and State)	Lease	Caribou	T7S R44E Sec. 17, 20, 21, 28
Subtotal - Itafos Conda Projects	2,840			Caribou	All Locations
PH	2,500	Mixed (Federal, State and Private)	Lease/Own	Bear Lake	T14S R 43E Sec. 8, 9, 10, 15, 16, 17, 21, 22
Total Property	5,340			Caribou & Bear Lake	All Locations
CPP	3,729	Private	Own	Caribou	T7S R42E Sec. 32, 33, and 34 T8S R42E Sec. 3, 4, 5, 9, 10, 11, 15, 16, 21, 22 T8S R44E Sec. 24, 25
Various	428	Private	Own	Caribou	Various
Wooley Valley Tipple	1,680	Private	Own	Caribou	T7S R43E Sec. 10, 14, 15, 22, 23, 26, 27
Other Leases	9,031	Mixed (Federal and State)	Lease	Various	Various

The Property is depicted on Figure 2-1, and individually on Figure 4-1, Figure 4-2, Figure 4-3, and Figure 4-4. These figures depict the locations of the Property boundaries relative to towns and major highways and access roads, and for each project the mineral lease types, surface ownership, major license/permit boundaries and deposit locations relative to the Property boundaries.

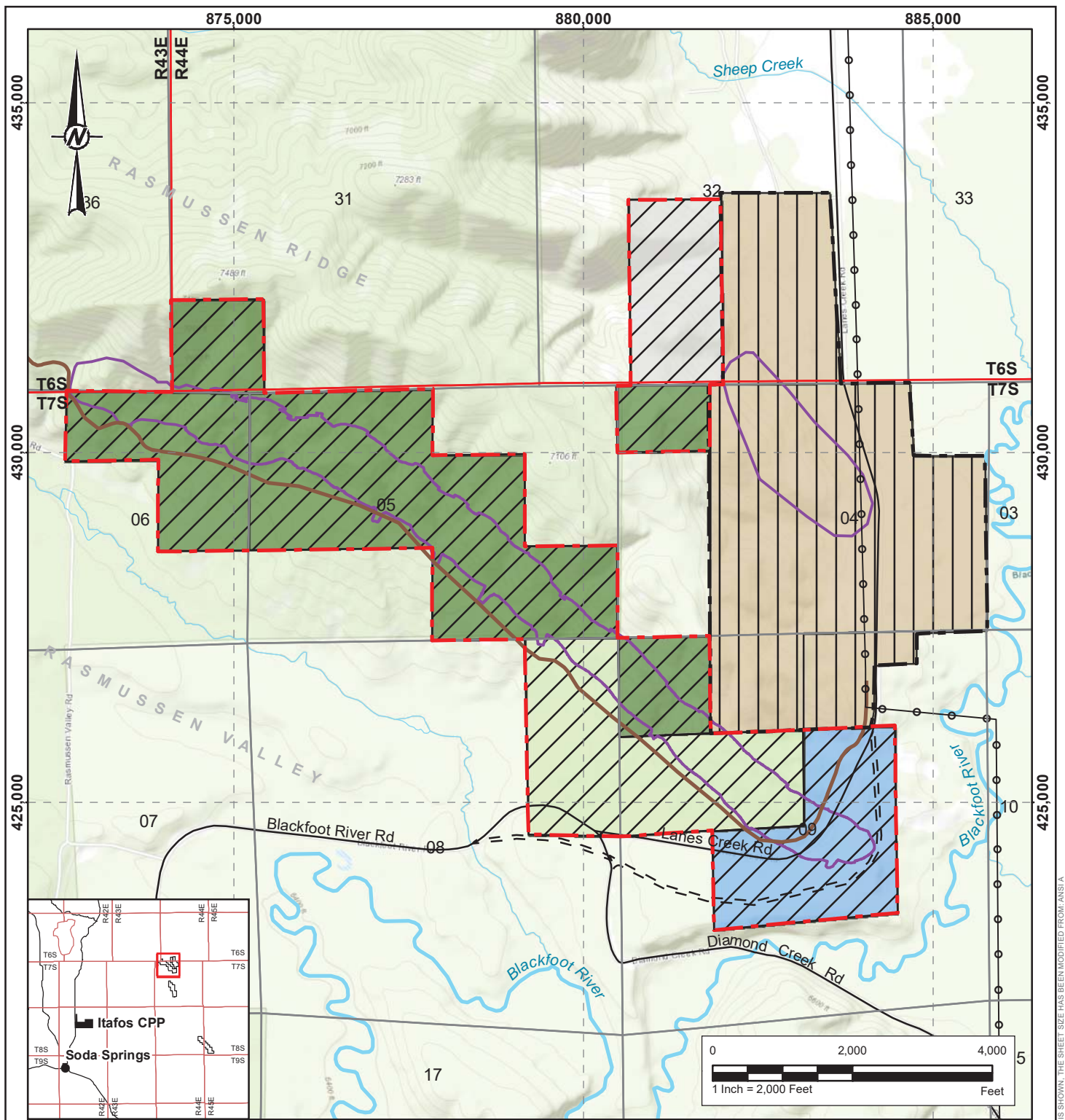

LEGEND

- RVM Lease Boundary
- LCM Lease Boundary
- Township and Range
- Section
- Pit Extent
- Road
- Future Road Realignment
- Haul Road
- Powerline
- River/Stream

Mineral Owners

Bear Lake Grazing Co.

Federal

Surface Owners

Bear Lake Grazing Co.

Itafos Conda LLC

Other - Uncontrolled

Idaho Fish and Game

Federal

REFERENCE(S)

1. COORDINATE SYSTEM: NAD 1983 STATE PLANE IDAHO EAST FIPS 1101 FEET
2. DATA PROVIDED BY ITAFOS CONDA LLC

CLIENT
ITAFOS CONDA LLC

PROJECT
NI 43-101 TECHNICAL REPORT FOR CONDA PHOSPHATE OPERATIONS

TITLE
RASMUSSEN VALLEY MINE AND LANES CREEK MINE PROPERTY MAP

CONSULTANT
YYYY-MM-DD 2019-12-12

DESIGNED	-
PREPARED	EFT
REVIEWED	RM
APPROVED	TM



PROJECT NO. 18114499	CONTROL 0001	REV. -	FIGURE 4-1
-------------------------	-----------------	-----------	---------------

IF THIS MEASUREMENT DOES NOT MATCH WHAT IS SHOWN, THE SHEET SIZE HAS BEEN MODIFIED FROM: ANSI/A 11in

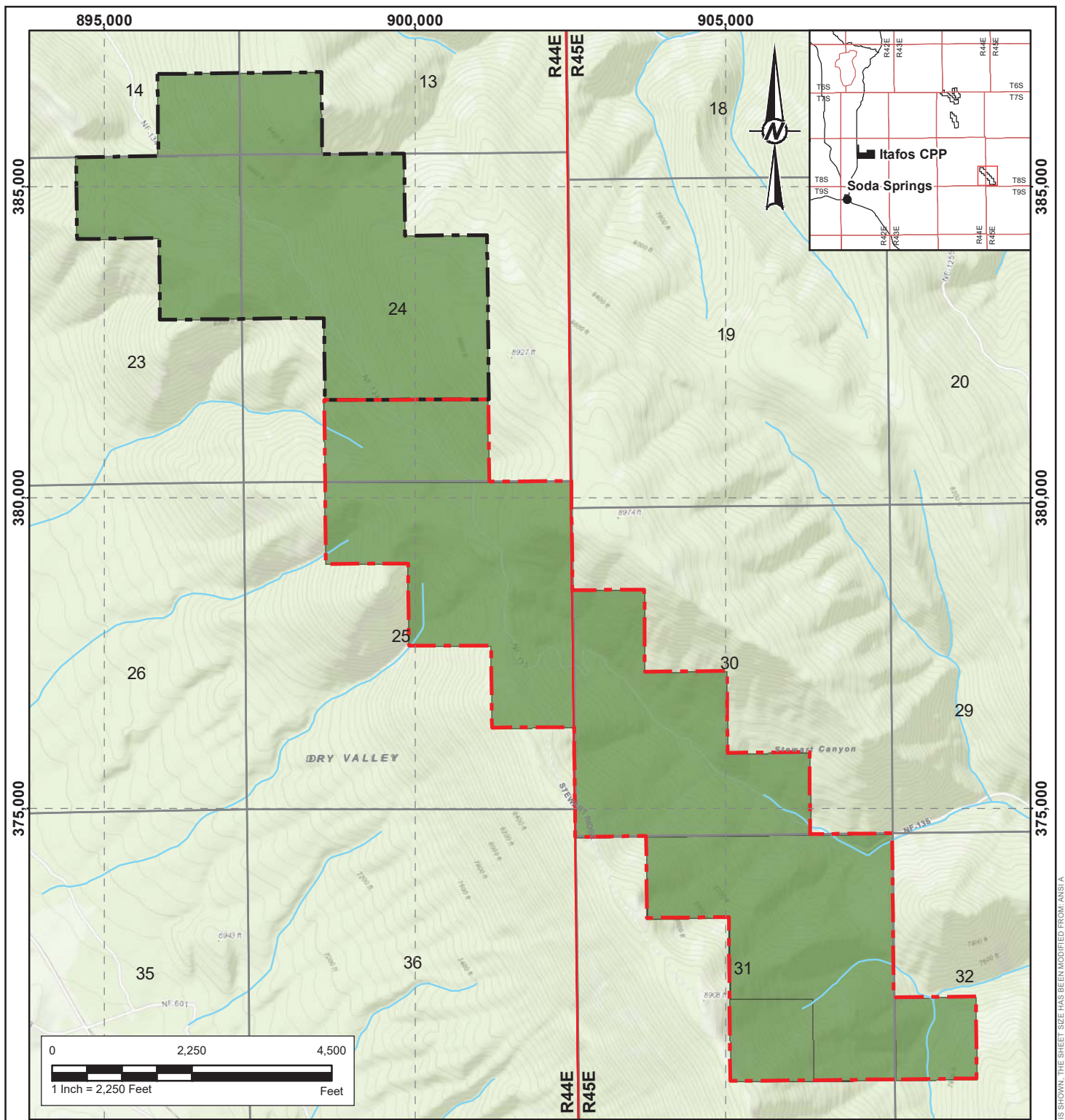

LEGEND

- H1 Lease Boundary
- H1 KPLA
- Township and Range
- Section
- River/Stream

Surface and Mineral Owners

- Federal

REFERENCE(S)

1. COORDINATE SYSTEM: NAD 1983 STATE PLANE IDAHO EAST FIPS 1101 FEET
2. DATA PROVIDED BY ITAFOS CONDA LLC

CLIENT
ITAFOS CONDA LLC

PROJECT
NI 43-101 TECHNICAL REPORT FOR CONDA PHOSPHATE OPERATIONS

TITLE
HUSKY 1 PROPERTY MAP

CONSULTANT	YYYY-MM-DD	2019-11-22
	DESIGNED	-
	PREPARED	EFT
	REVIEWED	RM
	APPROVED	TM



PROJECT NO.	CONTROL	REV.	FIGURE
18114499	0001	-	4-2

1 in IF THIS MEASUREMENT DOES NOT MATCH WHAT IS SHOWN, THE SHEET SIZE HAS BEEN MODIFIED FROM: ANS/A

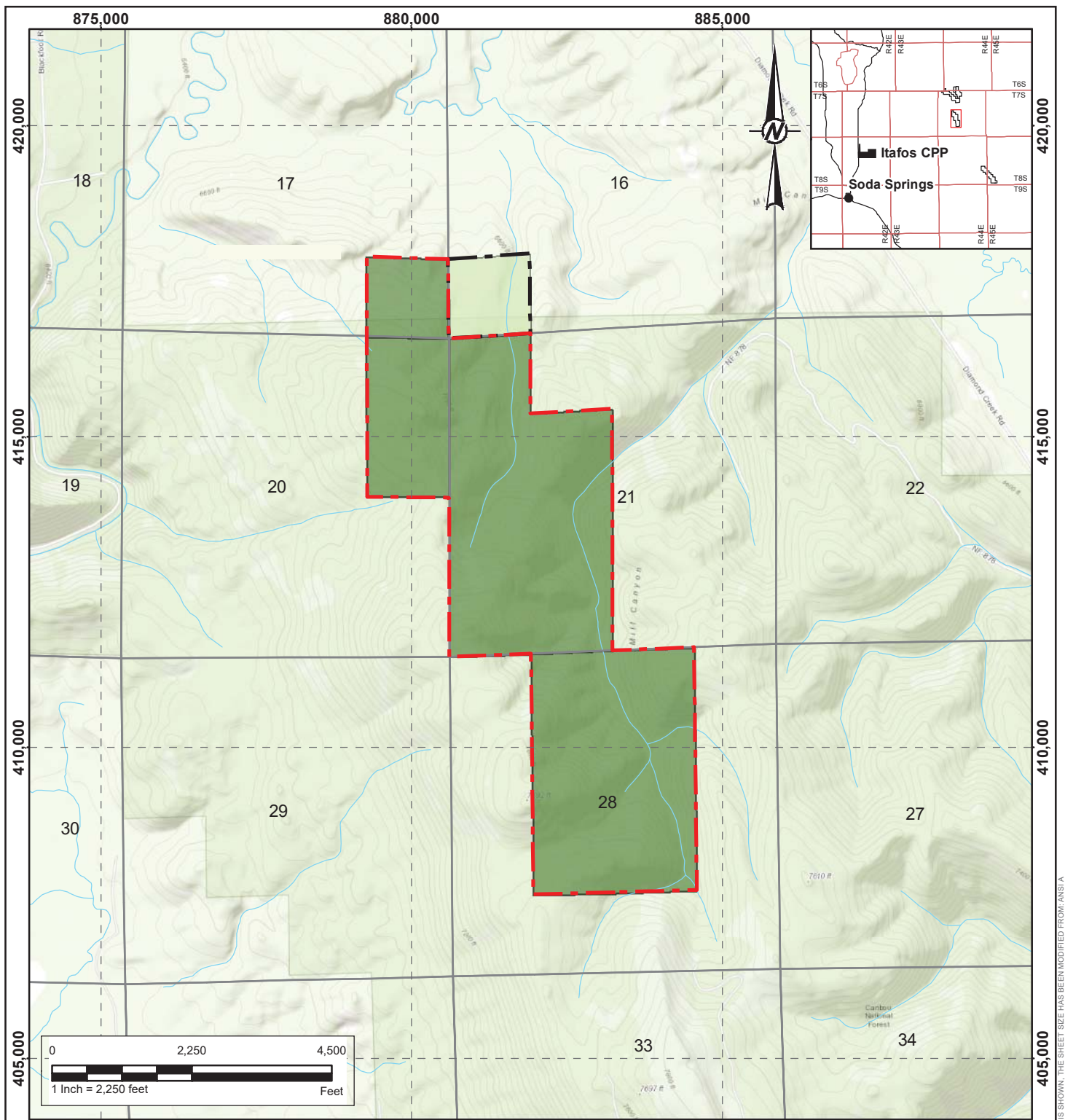

LEGEND

- North Dry Ridge Lease Boundary
- North Dry Ridge State Lease Boundary
- Section
- River/Stream

Surface and Mineral Owners

- Federal
- State of Idaho

REFERENCE(S)

1. COORDINATE SYSTEM: NAD 1983 STATE PLANE IDAHO EAST FIPS 1101 FEET
2. DATA PROVIDED BY ITAFOS CONDA LLC

CLIENT
ITAFOS CONDA LLC

PROJECT
NI 43-101 TECHNICAL REPORT FOR CONDA PHOSPHATE OPERATIONS

TITLE
NORTH DRY RIDGE PROPERTY MAP

CONSULTANT

YYYY-MM-DD 2019-11-22

DESIGNED -

PREPARED EFT

REVIEWED RM

APPROVED TM



PROJECT NO.
18114499

CONTROL
0001

REV.
-

FIGURE
4-3

1 in IF THIS MEASUREMENT DOES NOT MATCH WHAT IS SHOWN, THE SHEET SIZE HAS BEEN MODIFIED FROM: ANS/A

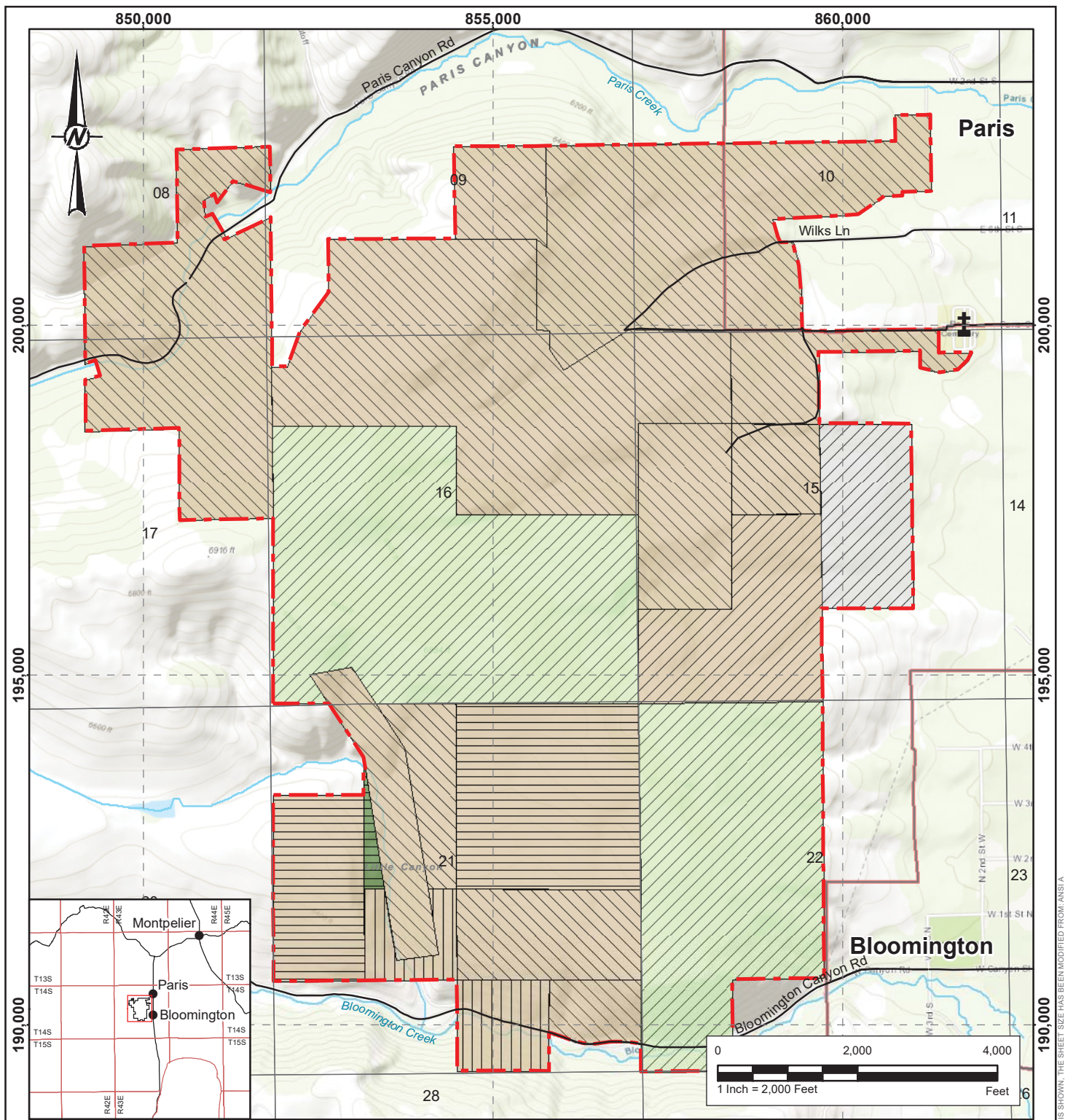

LEGEND

- ▬ Paris Hills Mine Boundary
- City/Town
- Section
- Road
- ~ River/Stream
- + Cemetery

Mineral Owners

- Private
- State of Idaho
- Federal Phosphate Lease - In Place
- Federal Phosphate Lease - Pending

Surface Owners

- Private
- Other - Uncontrolled
- State of Idaho
- Federal

CLIENT
ITAFOS CONDA LLC

PROJECT
NI 43-101 TECHNICAL REPORT FOR CONDA PHOSPHATE OPERATIONS

TITLE
PARIS HILLS PROPERTY MAP

CONSULTANT
YYYY-MM-DD 2019-12-12

DESIGNED	-
PREPARED	EFT
REVIEWED	RM
APPROVED	TM



REFERENCE(S)
1. COORDINATE SYSTEM: NAD 1983 STATE PLANE IDAHO EAST FIPS 1101 FEET
2. DATA PROVIDED BY ITAFOS CONDA LLC

PROJECT NO. 18114499	CONTROL 0001	REV. -	FIGURE 4-4
-------------------------	-----------------	-----------	---------------

IF THIS MEASUREMENT DOES NOT MATCH WHAT IS SHOWN, THE SHEET SIZE HAS BEEN MODIFIED FROM: ANSI A

4.2 Mineral Tenure, Surface, and Other Rights

The Property is controlled solely by Itafos through its 100% subsidiaries, Itafos Conda LLC (Itafos Conda) and Paris Hills Agricom, Inc. (PHA). Itafos' subsidiaries control surface and mineral rights on the Property through leases from private landowners and on public lands from the State of Idaho and U.S. Federal government. Table 4-2 shows for each mineral project the type of mineral tenure (private, State or Federal lease) and the identifying name or number of each; the nature and extent of Itafos' title to, or interest in, the Property including surface rights, legal access, and the expiration date of each lease. As shown, Federal Leases are for indefinite terms; however, the Bureau of Land Management (BLM) may make reasonable adjustments to the lease conditions once every 20 years.

Table 4-2: Mineral Tenure, Surface, and Other Rights for Itafos Conda and Paris Hills Projects

Lessor	Lease Number	Lease Rights *	Expiration or Adjustment Dates
<u>Lanes Creek Mine</u>			
Private	BLG1	S, AM	On completion of all reclamation requirements.
<u>Rasmussen Valley Mine</u>			
Federal	I-005975	S, AM	Indefinite term. Lease is subject to adjustment in June 2035
<u>Husky-1 Project</u>			
Federal	I-5549	S, AM	Indefinite term. Lease is subject to adjustment in June 2036
<u>North Dry Ridge Project</u>			
Federal	I-8289	S, AM	Indefinite term. Lease is subject to adjustment in Oct 2023.
State	E800021	S, AM	Jan 2023
<u>Paris Hills Project</u>			
Private	BE1	S, AM	Aug 2032
Private	CHR1	S, AM	Jan 2032
State	E800005	S, AM	Feb 2023
State	E800006	S, AM	Feb 2023
State	E800026	AM	Feb 2023
Private	ESI1	S, AM	Dec 2022
Private	GAM1	AM	Mar 2032
Private	GON1	S, AM	Jan 2032
Federal	IDI-12982	P	July 2022
Federal	IDI-036773	P	Preference Rights Application, Permit Pending
Private	TRL1	S, AM	Sept 2021
Private	WBD1	S, AM or FM	Aug 2028
Private	WF1	S, AM or AEP	Aug 2028

As denoted by an asterisk in Table 4-2, the “Lease Rights” codes have the following meanings:

- S: Surface Only, which provide rights to use the surface for access, construction, and operations.
- P: Federal Phosphate Only, federal reservation of phosphate under the Act of 17 July 1914 (38 Stat. 509, as amended by the act of 20 July 1956 (70 Stat. 592) (codified at 30 USC § 121–123).
- AM: All Minerals, which provides the right to extract all minerals, including phosphate with no federal reservation.
- FM: Fractional Minerals, which is a lease of an interest of less than 100% of the mineral interest as divided by grant or reservation of mineral interests to a number of different owners.
- AEP: All Minerals Except Phosphate (Federal Reservation), which is a lease of all other minerals on parcels subject to the federal reservation of phosphate.

Royalties, Encumbrances, Other Obligations, and Licenses

This part describes the obligations that must be met to retain the Property, and to the extent known, the terms of any royalties, back-in rights, payments, or other agreements and encumbrances to which the Property is subject.

The surface and mineral leases held by Itafos require payments specified by regulation or lease to retain the Property. Such payments include surface rentals, advance royalties, and production royalties. The payments under the federal, state, and private leases are summarized as follows.

Federal lands and minerals are held under leases with the BLM. For properties that are not in production, including H1 and NDR, advance rental / minimum royalty payments required to hold the leases vary from \$1 to \$3 per acre and are due each year. In addition, Itafos was required to post a royalty payment bond with BLM for about \$1 Million securing RVM royalty payments, and a statewide lease bond of \$25,000 that covers all other Idaho federal leases in Itafos Conda LLC’s name.

Production royalties due under federal leases are based upon dry tons delivered to the CPP. The P₂O₅ content of the tons delivered is multiplied by the prevailing federal Unit Value, which is currently \$1.377, to arrive at a gross ore value subject to the 5% royalty specified in the lease.

State lands and minerals are held under leases with the State of Idaho Department of Lands. For properties that are not in production, advance rental / minimum royalty payments are required to retain the leases and vary from \$1 to \$3 per acre each year.

State production royalties use the same payment formula as the federal production royalty, but payments are based on dry tons of ore delivered to the rail loadout.

Private land and minerals are held under leases with numerous landowners including large ranching and agricultural entities as well as individuals and families. At Lanes Creek, production royalties payable to the private owners equal the federal royalty minus \$0.10 per dry ton of ore. In addition, overriding royalties are paid to former private lease interest holders in the total amount of \$0.55/dry ton of ore. All private royalties on Lanes Creek production are paid on tons delivered to the rail loadout.

At the Paris Hills Project, surface and mineral rights are controlled under 21 separate leases with private landowners. Advance royalties and surface rentals payable to the lessors vary by lease in amounts but are all due annually. Currently, to retain the Paris Hills leases, annual payments of advance royalties and surface rentals amount to about \$365,000 per year and will increase by \$2,000 in 2021.

No production royalties are due on the Paris Hills leases because no mining has commenced on any lease.

There are no other obligations required to retain the Paris Hills leases, payments, agreements, or encumbrances to which the Paris Hills Property is subject.

4.3 Environmental Liabilities

To the extent known, current environmental liabilities to which the Property is subject are summarized by project on Table 4-3.

Table 4-3: Current Environmental Liabilities by Project

Project	Source of Liability	Type of Liability	Current Liability Amount in US\$, If Known
Lanes Creek Mine	Areas affected by historical mining	Reclamation and closure	Included in current \$16.5 M LCM reclamation bond amount
	Areas affected by current mining activities	Reclamation and closure	Included in current \$16.5 M LCM reclamation bond amount
Rasmussen Valley Mine	Areas affected by current mining activities	Reclamation and closure	\$21.3 M (Reclamation bond amount)
Husky 1 Project	None	None	\$18 k
North Dry Ridge Project	None	None	\$0
Paris Hills Project	None	None	\$0

Additional information is also provided in Item 20 of this NI 43-101 Technical Report related to environmental studies and the asset retirement obligations (ARO) estimated for future mine closure costs related to each project on the Property.

In 2018, Itafos acquired the CPP from Agrium. Agrium and Potash Corporation merged to form Nutrien Ltd. As part of these transactions, Nutrien retained past historical and legacy liabilities at CPP and is subject to an Administrative Order on Consent (AOC) (Docket No. RCRA-10-2009-0186), which was entered with the United States Environmental Protection Agency (USEPA) in 2009. Item 24 of this NI 43-101 Technical Report provides additional information on the CPP and the AOC.

4.4 Permits

LCM is permitted under State of Idaho laws and regulations. RVM is permitted under Federal Regulations by the BLM under the authority of the Mineral Leasing Act (MLA) and National Environmental Policy Act (NEPA), which required an Environmental Impact Statement (EIS) resulting in a Record of Decision (ROD) from the BLM. In addition, SUPs may be required as part of the State and Federal permitting processes. These permits could include, but not be limited to, land use for haul road and staging area, sedimentation basins, stockpile locations, surface water runoff areas, and interceptor ditches. Supplemental permits may include but not be limited to air permit, stormwater general permit, permit to construct a drinking water system, septic system permit, stream alteration permit, and wetlands (404 Permit) permit.

To the extent known, Table 4-4 shows the permits that must be acquired to conduct the work proposed for each project, and the permits that have been obtained to the Effective Date of this Technical Report.

Table 4-4: Permits Acquired and to be Acquired for Itafos Mines and Projects

Project	Work Proposed	Permits Acquired or Required	Current Status
Lanes Creek Mine	Production	(Mine and) Reclamation Plan Amendment (S00509) Final Order (Signed Approval) Point of Compliance Determination Point of Compliance Modification Point of Compliance -- Baseline and Background Concentration of Constituents Storm Water Pollution Prevention Plan (SWPPP) United States Army Corp of Engineers (USACE) – 404 Permit Idaho DEQ – 401 Certification Consultation with NOAA Fisheries Stream Alteration Permit Conditional Use Permit to Construct	Acquired
		Modification of existing permits and approved Mine and Reclamation plans to backfill final phases of LCM with RVM overburden.	Required
Rasmussen Valley Mine	Production	Notice to Proceed Lease Modification Approval Conditional Use Permit Point of Compliance Determination EIS and ROD Spill Prevention Control and Countermeasure (SPCC) Plan Environmental Monitoring Plan	Acquired
		Modification of existing permits and approved Mine and Reclamation plans to backfill final phases of RVM with LCM overburden.	Required
Husky-1 Project	Development	BLM: EIS ROD, Notice to Proceed, Lease Modification Approvals USFS: ROD and Special Use Permit(s) USACE: 404 Permit and Stream Alteration Permit IDEQ: 401 Permit, Permit to Construct (Air Permit), SWPPP, and Points of Compliance (POC). IDL: Mine Reclamation Approval Caribou County: Conditional Use Permit	Required
North Dry Ridge Project	Development	BLM: EIS ROD, Notice to Proceed, Lease Modification Approvals USFS: ROD and Special Use Permit(s) USACE: 404 Permit and Stream Alteration Permit IDEQ: 401 Permit, Permit to Construct (Air Permit), SWPPP, and Points of Compliance (POC). IDL: Mine Reclamation Approval Caribou County: Conditional Use Permit	Required
Paris Hills Project	Studies	Three IDL exploration permits (TP-80-2176, TP-80-2177, and TP-80-2178). No other permits required at current project planning stage.	Acquired

4.5 Significant Factors or Risks Affecting Access, Title, Right or, Ability to Work on the Property

There are no known significant factors or risks that may affect access or title to any of the mineral projects described in this Technical Report.

Itafos Conda Projects

To the extent known, the following significant factors and risks may affect Itafos' right or ability to perform work on the Itafos Conda projects.

The LCM and RVM are production-stage projects. The LCM is near the end of its mine life and the remaining LCM tonnage to be mined will be scheduled to support mine production from the RVM. The RVM is in the early stages of its projected mine life.

Significant factors and risks that may affect the right or ability to perform work at LCM and RVM are operational in nature and include primarily diligence in mine operations to maintain production; that is, assuring safety in design, engineering, operations, prudent management of air quality, water management (stormwater, Clean Water Act, NPDES/IPDES, etc.), environmental monitoring, pit backfilling, and concurrent reclamation.

To optimize the backfilling requirements at the RVM and LCM, Itafos Conda will submit permit modifications to the existing permits and currently approved Mine and Reclamation plans (MRPs). The permit modifications will be submitted in the first quarter of 2020 for modified backfilling operations to start in the second half of 2020. The proposed action will be to backfill the LCM with overburden from the early phases of the RVM. Then backfill the final phases of the RVM with the LCM overburden currently stockpiled externally near the LCM pit. Itafos Conda considers these permit approvals of moderate risk.

The right and ability to work at other projects on the Property may depend on prudent and effective post-mining work at LCM and RVM including environmental monitoring, maintenance (surface and ground water monitoring, Point of Compliance requirements, and so forth), and achieving reclamation goals and objectives.

The following significant factors, as discussed below, and risks may affect the right or ability to perform work on the H1 and NDR projects.

Timely Approvals and Authorizations by Regulatory Agencies and Private Adjacent Operators

Mining at H1 and NDR will be contingent on the approval from the Federal and State regulatory agencies based on compatibility with NEPA. It will also be contingent on successful execution of agreements with Nutrien. The specific activities needed for a safe, environmentally sound, and efficient operation are described below. Itafos expects that these proposed activities are of moderate risk and very similar to the risk that operators in the area have experienced (including Itafos' predecessors) in the recent past. Notable for the activities describe below is that the agency preferred best management practices (BMPs) are to maximize orebody development and to backfill historical pits to the extent practical. Also, Itafos anticipates continued co-operation from Nutrien as was experienced during the 2018 acquisition of Conda and other on-going agreements.

The NEPA process may be complicated by non-governmental organizations (NGOs) use of US federal courts to oppose and litigate against any Record of Decision (ROD) issued by a US government agency or department. This process of litigation in the US federal courts may cause substantial delays in obtaining the necessary permits and authorizations. These delays are often measured in years and can add substantial legal and project holding

costs to the project. Over the past 20 years four RODs issued by the BLM Pocatello Field Office concerning phosphate projects have been litigated by NGOs. In each of these cases the government prevailed, the ROD was upheld, and the projects were allowed to proceed timely as permitted.

An unleased "Known Phosphate Leasing Area" (KPLA) lies just north and adjacent to the H1 Lease. Itafos intends to combine this KPLA into the H1 lease through the general permitting and lease modification process. Extent of phosphate mineralization in the KPLA and integration into the proposed H1 mining operation will be demonstrated in a MRP. It is fully expected that the KPLA will be approved with H1.

Within the KPLA's proposed mining area exists a buried pipeline currently in use by a separate company. An Agreement is in place that the pipeline will be relocated at the owner's expense (engineering, permitting, and construction) at the request of Itafos based on the approved MRP. Itafos has every intention to communicate and co-operate with the owner for a timely and cost-effective relocation of the pipeline.

Within the KPLA and the H1 lease exists a United States Forest Service (USFS) road currently accessed by the general public. Itafos will propose various alternatives to the USFS for consideration of road relocation to protect the public from mining activities. An agreement with the USFS is considered low risk to the permitting process since numerous alternatives exist.

A powerline exists within the NDR lease and proposed mining area. An Agreement is in place with the utility company to relocate the powerline at the owner's expense. Itafos has every intention to communicate and co-operate with the owner for a timely and cost-effective relocation. In lieu of relocation, the powerline owner has the option to reimburse Itafos for any lost value attributable to not relocating the powerline.

The NDR lease and proposed operation is partially overlapping and adjacent to an Idaho Department of Fish and Game Wildlife Management Area (WMA). Although the lease extends into the WMA, Itafos is proposing to not extract phosphate rock from that portion of the lease. The current RV mine operation is partially overlapping the same WMA; similar permitting risk, operational methods and monitoring are assumed for NDR.

As part of the MRP and general permitting process, Itafos is proposing to utilize the Maybe Canyon lease (held by Nutrien) which is located directly between the proposed KPLA/H1 and NDR pit areas. The Maybe Canyon lease contains the historical North and South Maybe Canyon Mines (completed in 1993) where access roads and partially backfilled open pits still exist. Itafos is proposing to access the KPLA/H1 pit area through the South Maybe Canyon Mine (SMCM), extract the economical phosphate ore left behind within the southern extension and backfill the pits (to the extent practical) with overburden mined from the KPLA/H1 pit. Similarly, Itafos is proposing to access the NDR pit area by utilizing an existing private road owned by Nutrien and access roads developed through the North Maybe Mine (NMM). Backfilling the NMM pit with overburden from the NDR pit (to the extent practical) is also being proposed.

Phosphate ore will be hauled from the H1 and NDR pits to two potential ore stockpile and rail loadout facility (tipple) areas. The first location (base case for economics) is west of the H1 lease in the foothills of Dry Valley. The second location is near the Dry Valley Shop utilizing the existing rail and tipple. The first option is located on USFS land and the second option is located on a lease currently held by Nutrien. Ore will be loaded on a train and transported via existing rail (refurbishment will be required for a portion of the track) to the CPP. No additional permitting risk is assumed beyond what has been described. An Agreement with Nutrien will be required for the second option.

Maybe Lease (NMM and SMCM)

The NMM and the SMCM are currently undergoing investigation and remediation of impacts from selenium through CERCLA under an Administrative Settlement Agreement and Order on Consent (ASAOC) between the subsidiaries of Nutrien and several Federal Agencies (USFS is the lead agency). These sites are immediately adjacent to the H1 and NDR sites. Itafos is proposing to access H1 and NDR through the Maybe lease, extract the remaining economic phosphate rock from the SMCM and backfill (as much as practical) the open pits at both NMM and SMCM. Itafos considers the risk of timely permit approval and liability of comingling material is similar to the risk operators in the area have experienced (including Itafos). Notable is that the agency preferred BMPs are to maximize the extraction of the phosphate resource and to backfill historical open pits as much as practical. Proposed backfill methods will follow the currently approved methods at the on-going Itafos operations where overburden is selectively placed into the historic or proposed open pits. Current practices of backfilling overburden within the pit(s) is different from historical practices of permanently stockpiling overburden external to the pit(s). A significant portion of the current CERCLA activities at the NMM and SMCM has been focused on overburden placed external to the pits.

Other Federal Leases and Historical Mine Sites

The H1 and NDR leases are in proximity to other federal leases containing historical mine sites that are in various stages of ongoing assessment, investigation, and remediation under CERCLA of selenium impacts from these sites. These include Nutrien's Champ Mine (completed in 1986) and Nutrien's Mountain Fuel Mine (completed in 1993). The Champ historical mine is approximately 1.5 miles west of the H1 and NDR leases. The Mountain Fuel historic mine is approximately 3.5 miles SW of H1. None of these properties are expected to impact future operations at H1 and NDR.

Paris Hills Project

PH is not an advanced property because there is no current PFS or PEA for a mining project on the PH mineral resources. Currently, further studies are underway of potential development options for underground mining at PH. If a decision is made to advance the PH Project to development, then the following material risks must be successfully addressed.

Timely Approvals and Authorizations by Regulatory Agencies and Private Adjacent Operators

PH is an assemblage of Federal, State and Private lands and leases. Project permitting will ultimately fall under the NEPA process, an environmental permitting procedure, which is legislated and administered by agencies and departments of the US government. This potentially subjects the Project to longer and more arduous permitting processes than if just conducted by the various agencies and departments of the State of Idaho. Approximately 90% of the phosphate rock is contained within state and private land requiring only state approval. A phased permitting approach is practical and will likely be pursued.

Involving Federal lands can complicate the NEPA process with the ability of NGOs to use US federal courts to oppose and litigate against any ROD by a US government agency, or department. This process of litigation in the US federal courts can cause substantial delays in obtaining the necessary permits and authorizations. These delays are often measured in years and can add substantial legal and project holding costs to the Project.

Groundwater Pumping and Handling

Mining the PH mineral resources below the water table will require pumping, handling and disposal of large quantities of groundwater. Effectively managing and disposing of large water quantities from mine dewatering is a material risk at PH.

Phosphate Rock Transportation

PH is located about 50 miles from the CPP. Ore transportation from PH to the CPP requires careful consideration in terms of method, environmental and social impacts, and cost.

5.0 ACCESSIBILITY, CLIMATE, LOCAL RESOURCES INFRASTRUCTURE, AND PHYSIOGRAPHY

5.1 Topography, Elevation, and Vegetation

The Itafos Conda projects are situated in Caribou County, Idaho, see Figure 5-1. Topography, elevation, and vegetation are similar for each project. As shown on Figure 5-2, RVM is located on the southwestern flank of northwest-southeast trending Rasmussen Ridge. Rasmussen Ridge is directly south of the Grays Range and bounded by Rasmussen Valley to the south and Sheep Creek to the north. The local topography rises from 6,500 feet AMSL at the floor of Rasmussen Valley to a local peak at nearly 7,500 feet AMSL.

LCM is immediately to the east of RVM on the southeastern tip of Rasmussen Ridge and bounded to the east by Upper Valley. Local topography rises along the ridge from about 6,480 feet AMSL at the valley floor to a local peak of 6,870 feet AMSL, see Figure 5-2.

NDR is located about two miles south of RVM on the tip of the northwest-southeast trending Dry Ridge. As shown on Figure 5-3, NDR is on the northeast side of the tip and bounded to the north by the southern tip of Rasmussen Valley, to the east by Mills Canyon, and to the west by the western flank of Dry Ridge. From the ridgetop, the topography descends to the west to the floor of Dry Valley. Topography at NDR varies along the flank of the ridge from 6,700 feet AMSL in drainages to 7,600 feet AMSL at the ridgetop.

H1 is located about six miles southeast of NDR at the southern end of Dry Ridge and extending southeast along the flank of Stewart Ridge, see Figure 5-4. H1 is intersected by several drainages causing the topography to vary along the strike of the proposed mine. Local topography is relatively steep and varies from ridgetop elevations of nearly 8,900 feet AMSL to elevations in local drainages of about 7,700 feet. The northern part of H1 is on the western flank of Dry Ridge, which descends to the Dry Valley floor about two miles to the southeast. Stewart Canyon bisects H1.

Vegetation in the project areas typically consists of aspen or mixed aspen-conifer forest and high elevation rangelands on higher ridge elevations with big sagebrush shrubland dominating ridge flanks. Silver sagebrush shrublands cover lower elevations and non-wetland valley floors. Wetlands occur at lower elevations near existing creeks and streams on valley floors.

The PH Project is located in Bear Lake County, Idaho about two miles west of the town of Bloomington and about 40 miles south of Soda Springs, see Figure 2-1. The Project is located in the foothills of the Bear River Range on the west side of Bear Lake Valley. From Bloomington, the topography rises steeply to the west from an elevation of about 6,000 feet AMSL to local peaks of over 6,900 feet AMSL. The Project area is bounded by the steep Paris Canyon to the north and Bloomington Canyon to the south.

The PH Project area is characterized as sagebrush steppe habitat and is within a mountain shrub zone. Vegetation consists of a sagebrush rangeland community that includes pasture grasses introduced for cattle grazing. Aspen and riparian vegetation including willows, cottonwood and other trees occurs closer to Bloomington and Paris Creeks.

5.2 Accessibility

Out of state personnel or visitors to the Itafos mines and projects typically arrive by air using the major international airport at Salt Lake City, Utah (UT), or regional airports at Pocatello, ID, and Idaho Falls, ID, and ground transportation, via US Interstate Highway 15 and US Highway 30, from those locations to Soda Springs, ID, if traveling to the Itafos Conda projects, or via US Highway 89, to Bloomington, ID, to visit PH.

Soda Springs is the closest town to the CPP and Itafos Conda mines and projects and is located at the intersection of Highway 30 and Highway 34. Soda Springs is 60 miles southeast of Pocatello, ID, 105 miles south Idaho Falls, ID, and 175 miles north of Salt Lake City, UT with each location serviceable by a commercial airport with daily flights. The CPP is accessible from State Highway 34 north of Soda Springs and then east on Conda Road to the facility.

Primary means of access to RVM, LCM, and H1 and NDR is from US Highway 34 north of Soda Springs, ID. Primary access roads to each mine from US Highway 34 are:

- East on Blackfoot River Road, and on Rasmussen Valley Road to RVM.
- East on Blackfoot River Road, through the Blackfoot Narrows, and north on Lanes Creek Road to LCM.
- East on Blackfoot River Road, on to Dry Valley Road and then through the South Maybe Canyon Mine to H1, or the North Maybe Mine to NDR. Alternatively, H1 and NDR can be accessed by way of the Blackfoot River Road, Diamond Creek Road, Stewart Canyon Road and then to H1 through SMCM, or to NDR, through the NMM.

In addition to the primary access roads, the mining areas are intersected by a series of recreational and agency (Caribou County and/or USFS) gravel roads and mine truck haul roads that provide access to these areas. In extreme weather, however, these roads may be seasonally closed.

The Union Pacific Railroad (UPRR) main line runs parallel to Highway 30 through Soda Springs and includes a north-bound rail spur that services industrial facilities north of town, including the CPP and mine areas, that runs parallel to Highway 34 and the Blackfoot River Road.

From Salt Lake City, UT, the Paris Hills Project is accessed via Interstate Highway 15 to US Highway 89, or from Soda Springs via Highway 30 south to US Highway 89. From US Highway 89, Bloomington Canyon Road and Paris Canyon Road may be used to access the PH Project area. These are all-weather roads maintained by Bear Lake County for year-round use that provide access from the towns of Bloomington and Paris, respectively. From the county roads, access to the Project site is via unimproved roads used by local ranchers.

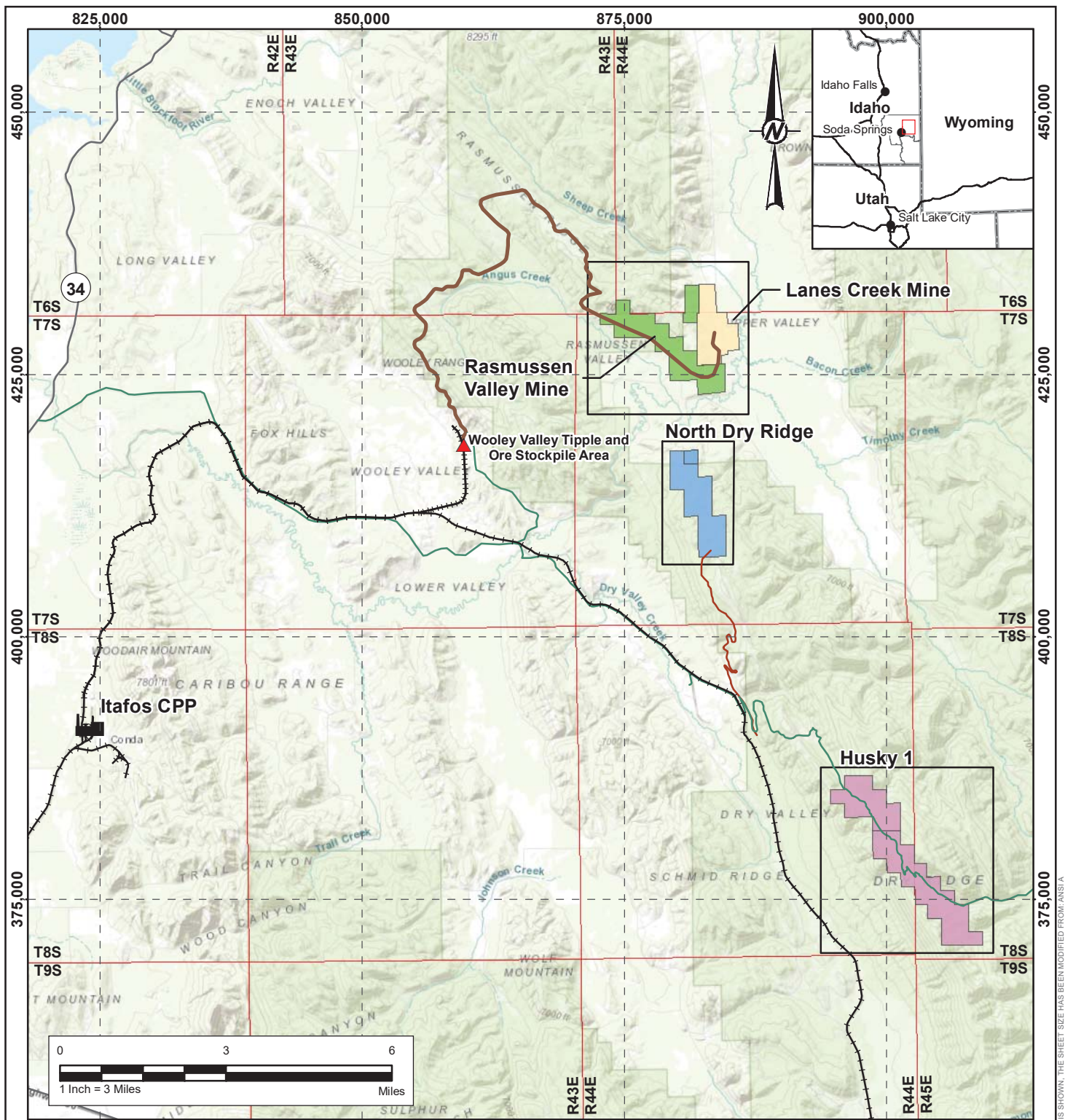

LEGEND

- Project Map Extents
- Township and Range
- State Highway
- Haul Road
- Public Vehicle Access
- Private Vehicle Access
- Railroad
- Itafos CPP
- ▲ Tipple

REFERENCE(S)

1. COORDINATE SYSTEM: NAD 1983 STATE PLANE IDAHO EAST FIPS 1101 FEET
2. DATA PROVIDED BY ITAFOS CONDA LLC

CLIENT
ITAFOS CONDA LLC

PROJECT
NI 43-101 TECHNICAL REPORT FOR CONDA PHOSPHATE OPERATIONS

TITLE
ITAFOS CONDA PROJECTS LOCATIONS MAP

CONSULTANT
YYYY-MM-DD 2019-11-22



DESIGNED	-
PREPARED	EFT
REVIEWED	RM
APPROVED	TM

PROJECT NO.	CONTROL	REV.	FIGURE
18114499	0001	-	5-1

1 in IF THIS MEASUREMENT DOES NOT MATCH WHAT IS SHOWN, THE SHEET SIZE HAS BEEN MODIFIED FROM: ANSIA

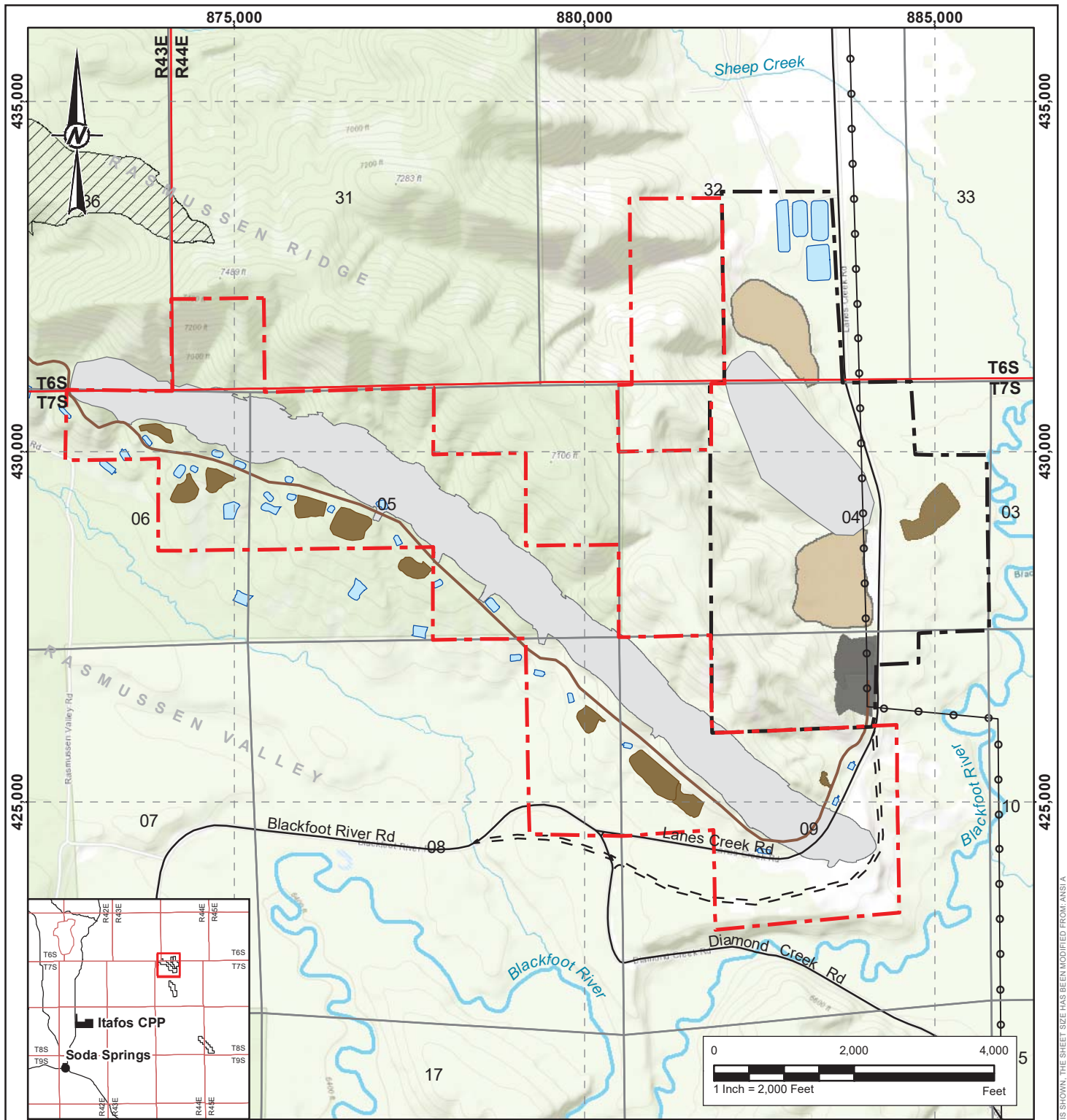

LEGEND

- RVM Lease Boundary
- Township and Range
- Section
- Pit Extent
- Ore Stockpile
- Growth Media Stockpile
- Overburden Stockpile
- P4 Backfill Pit
- ~ Pond
- Road
- Future Road Realignment
- Haul Road
- Powerline
- ~ River/Stream

CLIENT
ITAFOS CONDA LLC

PROJECT
NI 43-101 TECHNICAL REPORT FOR CONDA PHOSPHATE OPERATIONS

TITLE
RASMUSSEN VALLEY MINE AND LANES CREEK MINE LOCATION MAP

CONSULTANT
YYYY-MM-DD 2019-11-22

DESIGNED	-
PREPARED	EFT
REVIEWED	RM
APPROVED	-





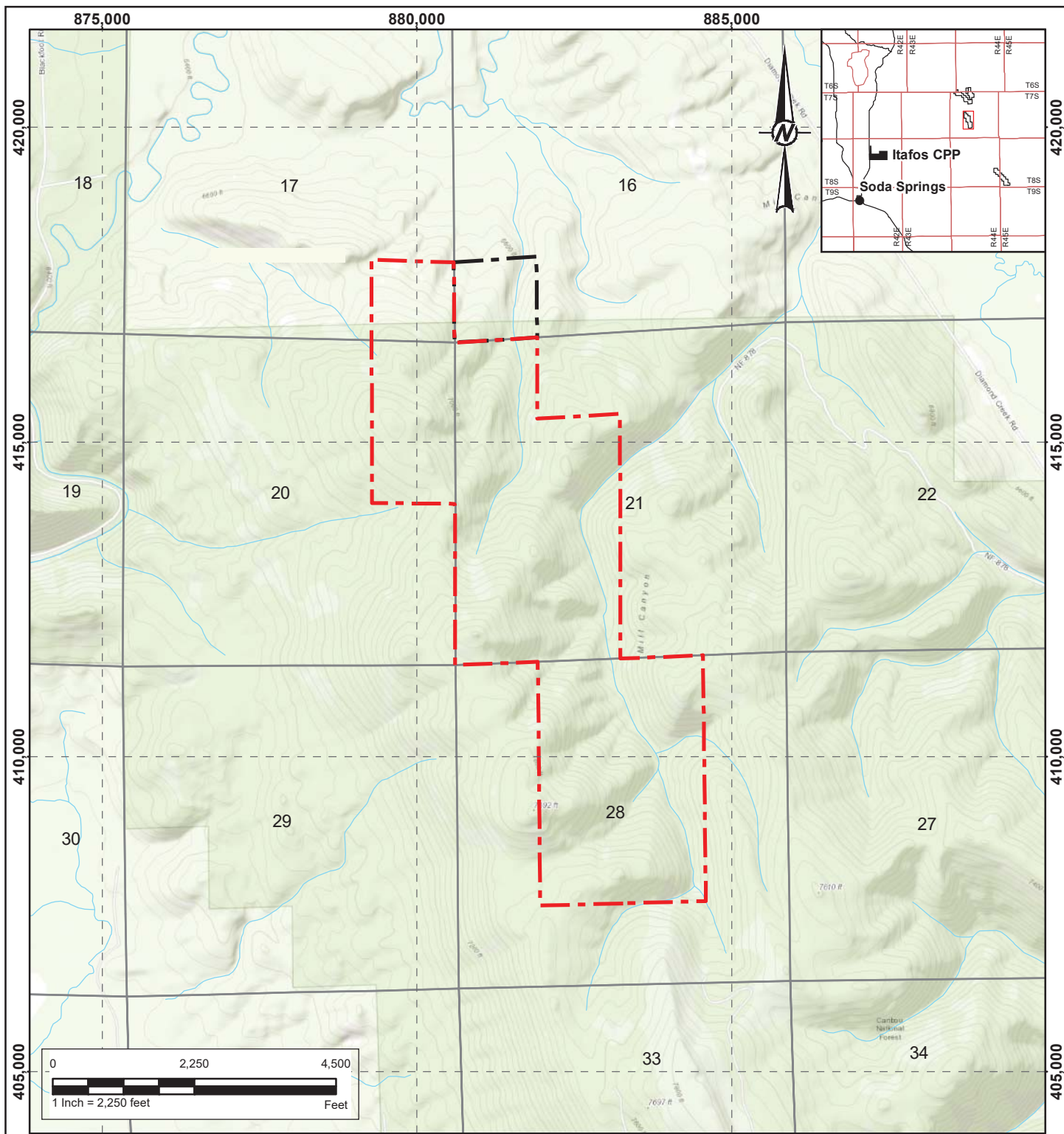

REFERENCE(S)
1. COORDINATE SYSTEM: NAD 1983 STATE PLANE IDAHO EAST FIPS 1101 FEET
2. DATA PROVIDED BY ITAFOS CONDA LLC

PROJECT NO. 18114499 CONTROL 0001 REV. - FIGURE 5-2

1 in IF THIS MEASUREMENT DOES NOT MATCH WHAT IS SHOWN, THE SHEET SIZE HAS BEEN MODIFIED FROM: ANSI/A



LEGEND

-  North Dry Ridge Lease Boundary
-  North Dry Ridge State Lease Boundary
-  Section
-  River/Stream

REFERENCE(S)

1. COORDINATE SYSTEM: NAD 1983 STATE PLANE IDAHO EAST FIPS 1101 FEET
2. DATA PROVIDED BY ITAFOS CONDA LLC

CLIENT
ITAFOS CONDA LLC

PROJECT
NI 43-101 TECHNICAL REPORT FOR CONDA PHOSPHATE OPERATIONS

TITLE
NORTH DRY RIDGE LOCATION MAP

CONSULTANT	YYYY-MM-DD	2019-11-22
DESIGNED	-	
PREPARED	EFT	
REVIEWED	RM	
APPROVED	TM	



PROJECT NO.	CONTROL	REV.	FIGURE
18114499	0001	-	5-3

IF THIS MEASUREMENT DOES NOT MATCH WHAT IS SHOWN, THE SHEET SIZE HAS BEEN MODIFIED FROM: ANSII A

1 in



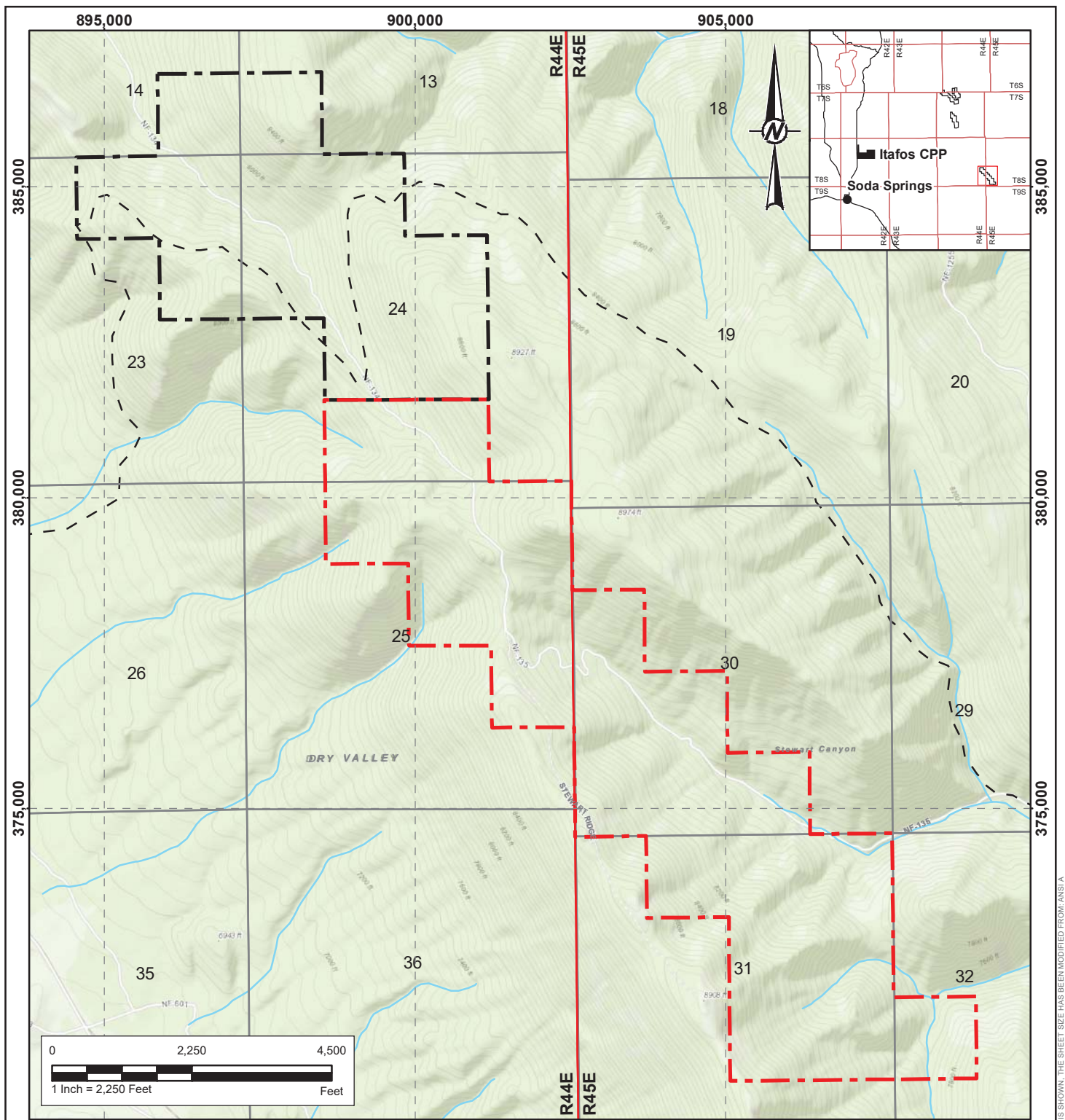

LEGEND

- H1 Lease Boundary
- H1 KPLA
- Township and Range
- Section
- Buried Pipeline
- River/Stream

REFERENCE(S)

1. COORDINATE SYSTEM: NAD 1983 STATE PLANE IDAHO EAST FIPS 1101 FEET
2. DATA PROVIDED BY ITAFOS CONDA LLC

CLIENT
ITAFOS CONDA LLC

PROJECT
NI 43-101 TECHNICAL REPORT FOR CONDA PHOSPHATE OPERATIONS

TITLE
HUSKY 1 PROPERTY LOCATION MAP

CONSULTANT

YYYY-MM-DD 2019-11-22

DESIGNED -

PREPARED EFT

REVIEWED RM

APPROVED TM



PROJECT NO.
18114499

CONTROL
0001

REV.
-

FIGURE
5-4

IF THIS MEASUREMENT DOES NOT MATCH WHAT IS SHOWN, THE SHEET SIZE HAS BEEN MODIFIED FROM: ANSII/A 11in

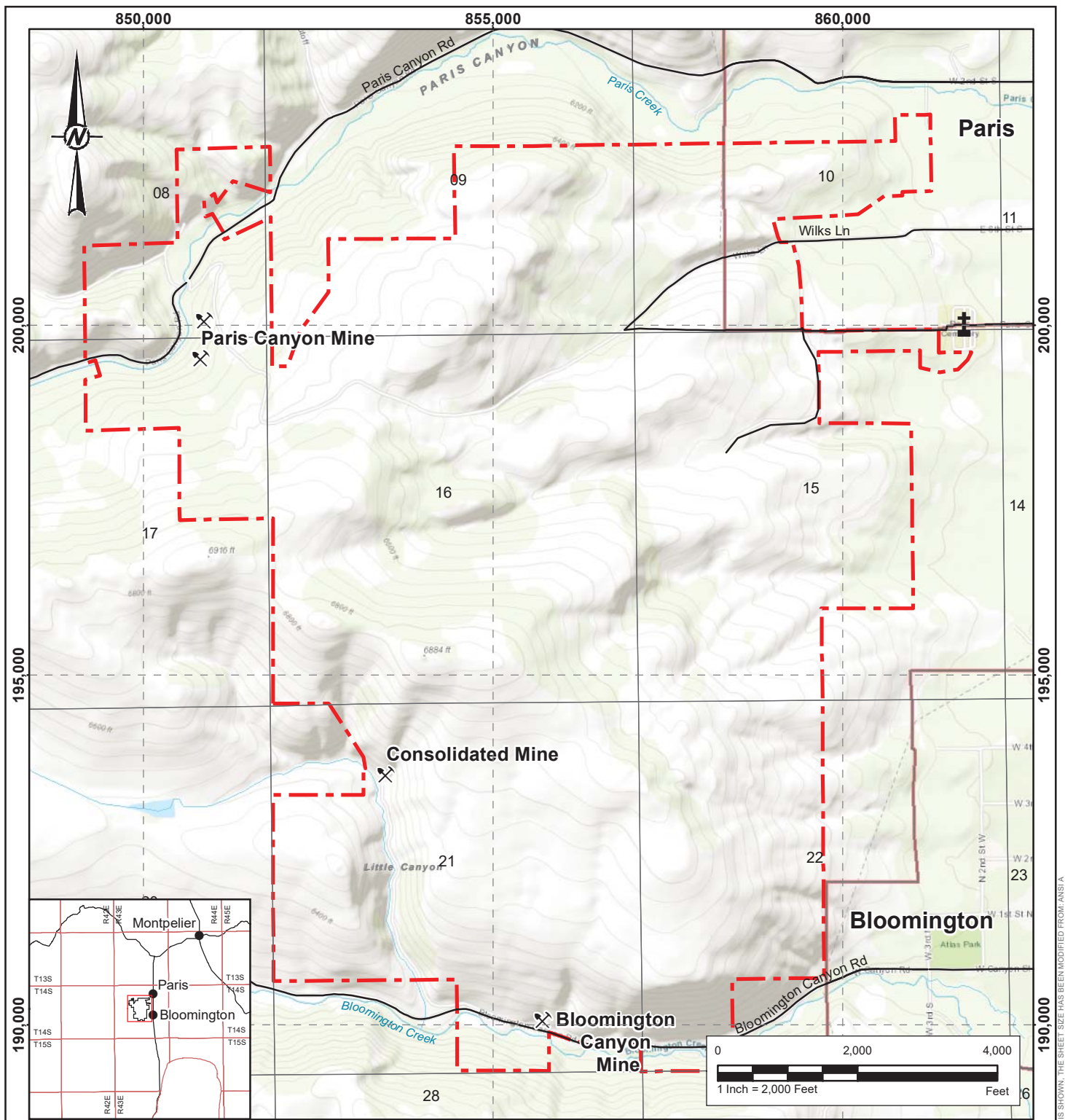

LEGEND

- - - Paris Hills Mine Boundary
- City/Town
- 1 Section
- Road
- ~ River/Stream
- ⌘ Historical Mine
- † Cemetery

REFERENCE(S)

1. COORDINATE SYSTEM: NAD 1983 STATE PLANE IDAHO EAST FIPS 1101 FEET
2. DATA PROVIDED BY ITAFOS CONDA LLC

CLIENT
ITAFOS CONDA LLC

PROJECT
NI 43-101 TECHNICAL REPORT FOR CONDA PHOSPHATE OPERATIONS

TITLE
PARIS HILLS LOCATION MAP

CONSULTANT	YYYY-MM-DD	2019-11-22
DESIGNED	-	
PREPARED	EFT	
REVIEWED	RM	
APPROVED	TM	



PROJECT NO.	CONTROL	REV.	FIGURE
18114499	0001	-	5-5

IF THIS MEASUREMENT DOES NOT MATCH WHAT IS SHOWN, THE SHEET SIZE HAS BEEN MODIFIED FROM: ANSI/A

5.3 Climate

The climate in southeastern Idaho is influenced by topographic features and prevailing westerly winds from the Pacific Ocean. Temperature and precipitation amounts are strongly dependent on elevation, with higher elevations experiencing lower temperatures and higher amounts of rain and snow.

The CPP is located 6 miles north of Soda Springs near Conda, Idaho. The reported average annual temperature at Conda over the last 30 years is 40 °F. The warmest months are July and August with an average temperature of 81 °F and a recorded high of 92 °F. The lowest temperatures occur in December and January with an average of 6 °F and a low of -18 °F. The average annual rainfall is about 19 inches and total snowfall averages 109 inches per year. January has the most snow with an average of about 26 inches.

Mining at the sites occurs year-round. Severe cold weather or significant snow events can affect mining for brief periods during winter. Exploratory drilling typically occurs between July and October.

At the PH Project, mean temperatures are expected to be similar to the temperatures at Conda, Idaho. Snow cover usually begins in November or December and may stay until April or May. Freezing temperatures persist into May, and frost can occur any month of the year at elevations above 6,500 feet AMSL. Precipitation amounts range from 10 inches in Bear Lake Valley to 20 to 30 inches over the PH Project. This climate may restrict exploration activities and surface operations in winter, but any future mining operation at PH will operate underground year-round.

5.4 Sufficiency of Surface Rights, Site, and Local Resources

Figure 5-1 through Figure 5-4 show the Property boundaries and locations of major access roads, mining pits, supporting infrastructure, water and power sources and supply, overburden storage areas, and rail loadout sites.

RVM and LCM have all supporting infrastructure required for mine operations. Infrastructure and facilities will require development to conduct mining at H1, NDR, and PH. See Item 18.0 for more detailed descriptions of existing and planned infrastructure for the projects.

Currently all projects have existing or reasonably available surface rights, power and water supply, mining personnel, and overburden disposal areas that are sufficient. For the Itafos Conda projects, Itafos controls all surface rights required for mining, and are currently negotiating the use of previously mined areas at the nearby SMCM and NMM. Extraction of the remaining ore from SMCM and backfill from both sites for overburden disposal from H1 and NDR is being proposed. These activities are subject to agency approval.

At PH, Itafos controls all private and state surface rights except for 80 acres on private land. This private surface area is not needed for underground extraction of the phosphate ore. The only Federal surface is a 6-acre parcel that is under a pending application by Itafos for a Federal lease. Itafos controls over 99% of the surface rights required for an underground mining operation. See Item 4 for a more detailed description of Itafos Property rights at the projects.

Water is supplied to the Itafos Conda mines and projects via water wells. Because of the remote locations of the mines, electricity requirements are limited to power provided by diesel generators. The WV Tipple is powered via transmission and distribution lines.

At PH, power is available from a 69-kilovolt (kV) main transmission line located approximately 2.4 km east of the town of Bloomington. Water rights in the Bear Lake Basin are fully subscribed. Water required for the Project or

consumed by the Project, will require water rights to be purchased. However, any mining project at PH will generate substantial quantities of water through mine dewatering, and therefore water supply should not present an issue.

Mining personnel are readily available in the area. Southeastern Idaho has a long history of exploration and mining activities. Phosphate ores have been mined commercially in Caribou County since the 1920's, and exploration and bulk sampling activities underground occurred at PH. The region is economically dependent on the mining and related industries and mining personnel are drawn from Caribou, Franklin, Bannock, Bear Lake and Lincoln (Wyoming), counties. Currently, through direct employment and use of mining and other contractors, Itafos Conda operations are responsible for over 500 locally employed people. Within the local region approximately 1,700 direct, indirect, and induced jobs are supported by the Itafos Conda operations.

At PH, there are no tailings storage or processing plant sites required or planned at any of the Project. All mined phosphate ore will be shipped to the CPP for further processing into fertilizer products.

6.0 HISTORY

Phosphate exploration and mining began in earnest in Caribou County, Idaho in the 1920s. Over the years, phosphate mining on the Property has grown to a multi-mine operation that includes several open pit phosphate mines. The CPP has an almost 60-year history of sustainable production of fertilizers.

6.1 Prior Ownership and Ownership Changes

The Itafos Conda projects consist of RVM, LCM, H1, and NDR projects that are held under leases granting surface access and phosphate mineral mining rights. Itafos Conda also controls numerous other phosphate mineral leases and properties in the vicinity that are prospective exploration targets.

As part of the merger between Agrium and Potash Corporation of Saskatchewan (forming Nutrien), Itafos acquired the Itafos Conda projects in early 2018.

The prior ownership of the Property and ownership changes are as follows by mineral project.

Rasmussen Valley Mine

The RVM is located on a federal lease and a portion of a state lease. The federal lease encompassing the RVM ore deposit was originally issued to J.A. Terteling & Sons in 1955. The Stauffer Chemical Company later acquired the lease in 1968, by FMC Corporation (date unknown), and by Astaris Production LLC in 2000. In 2004, the lease was transferred to Agrium. Itafos currently holds the lease and conducts mining operations at the RVM as part of their ongoing operations. Mineral and surface rights of the RVM are administered by the United States Bureau of Land Management (BLM) and the USFS, respectively.

Lanes Creek Mine

The LCM is located on private lands owned in fee by the Bear Lake Grazing Company (BLGC). Itafos holds the LCM surface and mineral rights as a fee lease from the BLGC. LCM was part of an initial 400-acre land patent obtained by George M. Pugmire in 1888 under the Desert Land Act. Sometime later, LCM was transferred to the Bear Lake Grazing Association, a cooperative of local area ranchers that included Pugmire and was the predecessor in interest to BLGC.

In early 1970, John Archer leased a portion of the original land patent from the BLGC and later sold the lease to Alumet. Archer maintained an asset interest with the rights of participation (overriding royalty). Alumet was a partnership between Earth Science, Inc. (20%), National Steel Corp. (40%), and the Southwire Co. (40%).

J.R. Simplot Company (Simplot) acquired the LCM lease in 1997 along with other Alumet phosphate holdings. Simplot conducted reclamation and stabilization activities of the existing overburden storage area and maintained the LCM's inactive status. Alumet retained an overriding royalty interest in the lease.

In 2015, Agrium acquired the LCM lease from Simplot as part of a Lease Exchange Agreement (LEA) and conducted additional site stabilization activities in preparation to reopen the LCM. Also, in 2015 Agrium gained approval from the IDL to mine the lease. Currently, Itafos mines the LCM lease as part of their ongoing phosphate operations.

Husky1 and North Dry Ridge

Agrium acquired the H1 and NDR leases as part of the 1995 acquisition of Nu-West Industries, Inc.. Prior to Agrium's 1995 acquisition, the leases were held by several entities. Mineral and surface rights of the H1 and NDR leases are administered by the BLM and the USFS, respectively. Itafos is the current lease holder for H1 and NDR through asset acquisition from Agrium.

Paris Hills

The PH Project area includes four historical underground mines that are shown on Figure 5-5. During the 1970s, Earth Sciences, Inc. (ESI) assembled a contiguous area that included the Paris Canyon Mine, the Consolidated/Little Canyon Mine, and the Bloomington Canyon Mine. The ESI Property consisted of privately held phosphate leases, state mineral leases, federal leases, prospecting permits, or applications and fee holdings. The ownership changes for each of the areas are as follows:

The Paris Canyon/McIlwee Mine is located in the northwest area of the PH Property and had the following ownership changes by years of each transaction:

- 1901 and 1913 - Margarett Grandi received two homestead patents from the United States BLM for what would become the Paris Canyon Mine.
- 1917 - The Property was purchased by the Western Phosphate Mining and Manufacturing Company of Salt Lake City, Utah.
- 1920 – The Western Phosphate Mining and Manufacturing Company was reorganized as the Western Phosphate Company led by James A. McIlwee.
- 1921 - The Western Phosphate Company filed for bankruptcy and McIlwee purchased the mine and formed Idaho Phosphate Company, which was later named McIlwee Phosphate Company and then McIlwee Idaho Phosphate Company.
- 1942 to 1950 - The Property was leased to the Metals Reserve Company (MRC).
- 1950 – The Property was sold to L.W. McGann.
- 1973 - The McGann holdings were sold to ESI.

The Consolidated/Little Canyon Mine is located in the southwest area of the PH Property and had the following ownership changes by year:

- 1903 - Historical work began with location of a claim in Little Canyon.
- 1908 - The original claim was replaced by three lode claims for phosphate rock and named the Star Nos. 1, 2, and 3. The prospectors were Joseph Oakey, G. W. Nebeker, and G. Spongberg.
- 1914 or early 1915 - The three lode mining claims were sold to the United States Phosphate Company of Michigan; the claims were patented in 1917.
- 1922 - The patented claims were transferred by the United States Phosphate Company of Michigan by quit claim deed to Francis A. Jeffs.

- 1930 - Solar Development Company, Ltd. (Solar), a subsidiary of Consolidated Mining and Smelting, Co. Ltd., acquired the Property by lease and option from Jeffs.
- 1938 - The lease and option held by Solar was returned to Jeffs.
- 1942 - The Property was optioned to Wyodak Coal Manufacturing Company (Wyodak)
- 1973 - ESI acquired the Property from the remaining landowners.

Bloomington Canyon Mine is located on the southern edge of the PH Property and had the following ownership changes by year.

- 1942 - The Property was optioned to Wyodak.
- 1962 – The Ruby Company (J. R. Simplot Co.) was the high bidder during a competitive phosphate lease sale from the BLM.
- 1973 - Ruby Company assigned the lease to ESI.
- 1984 - ESI assigned the lease to the Conda Partnership.
- 1993 - Conda Partnership assigned the lease back to ESI.

Bear Lake Mine is located just north of the northwest area of the PH Property and had the following ownership changes by year:

- 1914 - Walter H. Lewis gained a patent to the Property from the BLM.
- 1920 - Lewis contracted to sell his homesteaded lands to the Bear Lake Phosphate Company.
- 1921 - The Bear Lake Phosphate Company was granted a federal phosphate lease, which was the first federal phosphate lease issued in ID.
- 1926 - The Property was sold to Keystone Phosphate Company.
- 1930 – The private lands were transferred by quit claim deed to Agricultural Potassium Phosphate Company of California (APPC). The federal lease was assigned to Mary Stucki and others, who later subleased it to APPC.
- 1938 - The federal lease was terminated in 1938.
- 1970 – ESI applied for a prospecting permit, which was rejected upon application to convert to a preferential right lease in 1995.

The PH area is coincident with the southern portion of the former ESI Property, where the phosphate and vanadium beds are closest to the surface and crop out in Bloomington Canyon, Little Canyon, and Paris Canyon.

In 2007, RMP Resources, Corp. (RMP), a wholly owned subsidiary of Rocky Mountain Resources Corp. entered into a lease agreement and option to purchase with ESI for the three patented lode mining claims and additional associated fee property in Idaho of mineral and surface rights, a federal phosphate lease in Idaho, and four

patented lode and placer mining claims in Montana. The federal phosphate lease and all of the ESI fee property in Idaho are within the PH boundary. The total property position comprises an area of approximately 2,115 acres.

RMP and PHA, a wholly owned subsidiary of Stonegate Agricom, Ltd., entered into an agreement in 2009 whereby PHA acquired all of the interests of RMP under the mineral leases and the rights of RMP in the State of Idaho exploration permits and the federal prospecting permit.

In 2011 and 2012, PHA entered into five mineral lease agreements with private landowners.

On July 18, 2017, Itafos acquired Stonegate Agricom Ltd and now controls the PH Project.

In total, following all ownership changes the current PH Project encompasses an area of approximately 2,500 acres.

6.2 Exploration and Development History

This Item describes the type, amount, quantity, and general results of exploration and development work undertaken by previous owners, or operators, at each of the projects.

Rasmussen Valley Mine

At the RVM, exploration activities began in 1912 when two exploratory trenches were constructed by the USGS. Subsequent trenching in 1948 was conducted in the area as part of a larger program to study the area known as the Western Phosphate Field. Exploratory drilling has occurred intermittently at the RVM area since 1969; most recently from 2008 through 2010 by Agrium as part of the mine permitting process. Through 2011, over 100 exploratory borings have been completed in the RVM area at depths up to 550 feet.

In 2011, Agrium submitted a MRP to the BLM to develop the RVM Lease that includes both on-lease and off-lease activities. The BLM and the USFS in cooperation with the Idaho DEQ and the Walla Walla District of the US Corp of Engineers prepared an EIS to consider Agrium's Proposed Action for mining on the RVM Lease and the construction and operation of mine-related facilities outside the Lease. The EIS evaluated the impacts and effects of the Proposed Action and in January 2017, the BLM issued a ROD granting approval to proceed with the final permitting, development and construction of the RVM Lease and MRP.

Agrium began development of the RVM in 2017 and commenced phosphate mining operations at the mine in 2018.

Lanes Creek Mine

Phosphate deposits within the LCM were first explored in 1912 by the United States Geological Survey (USGS) and by other entities through the 1970s. The USGS exploration included two exploratory trenches/pits, across the phosphate ore beds. The trenches transected the entire ore deposit at this location. The original trenches were further explored, resampled, and later incorporated into the 1948 Western Phosphate Field study. In 1975, additional trench areas in the Lanes Creek area were excavated and mapped, likely by mining companies seeking to identify and mine the phosphate ore.

Alumet drilled the phosphate mineral zone on the LCM Lease in 1974, 1977, and 1978. In June 1978, Alumet submitted an MRP to the IDL proposing two years of phosphate mining and production of approximately 100,000 tons of phosphate ore. The initial plan was subsequently approved. In 1979 Alumet submitted an MRP amendment proposing additional mining operations that would remove up to 1.5 Mt of phosphate ore. Alumet's

1979 MRP also suggested three possible additional mine phases that could potentially extract significantly more phosphate. In 1979 the IDL approved the proposed 1.5-Mt phosphate MRP amendment. Alumet opened the LCM in the late 1970s and was operated until the mid-1980s removing only the upper portion of the ore body and modest volumes of phosphate ore. Mining activities by Alumet disturbed approximately 36 acres. Exact mine production during this time is not known.

Simplot acquired the LCM Lease in 1997 but did not conduct any mining. Simplot did conduct limited reclamation and stabilization of the existing overburden storage area in 1998 and conducted environmental monitoring activities in subsequent years.

In 2009, as part of a due diligence, Agrium drilled 26 exploration holes on the Property. In 2012, an option agreement was executed with Simplot which allowed Agrium to complete additional drilling and due diligence. In 2013, Agrium drilled an additional 24 in-fill exploration holes. Upon final acquisition from Simplot in 2015, Agrium conducted additional site stabilization activities in preparation to reopen the mine.

In 2015, Agrium submitted an MRP to IDL in accordance with the Idaho Surface Mining Act and the Idaho Administrative Procedures Act 20, Title 03, Chapter 02 to mine phosphate resources and reclaim historical mining areas on the private mineral lease. Agency approval to reopen the LCM was subsequently granted.

Husky 1 and North Dry Ridge

At H1, an exploration drilling program was conducted from 1969 to 1970, 1974, and 1981. Over 175 exploration borings were drilled during these years. Subsequently, Agrium drilled 55 holes in 2011, 95 holes in 2012 and 86 holes in 2014.

Exploration drilling at NDR was conducted in 1989 and 1990 and included 260 exploration borings. These activities occurred prior to Agrium's 1995 acquisition of Nutrien.

In April 2009, Agrium submitted the H1 and NDR Exploration Drilling Plan of Operations to the BLM.

In June 2010, the BLM Pocatello field office and the USFS Caribou Targhee National Forest completed an environmental assessment (EA) for the H1 and NDR Phosphate Exploration Project exploratory drilling in accordance with NEPA requirements. The BLM/USFS issued a Finding of No Significant Impact on June 16, 2010. With these approvals, 23 exploration drill holes were completed at NDR in 2013 to provide additional data for consideration.

In 2012, Agrium submitted an MRP to the BLM Idaho Falls District for the H1 and NDR mining project. The company proposed open-pit phosphate mining on the federal leases and Known Phosphate Lease Areas (KPLAs). In 2014, after three years of baseline data collection, Agrium suspended all permitting efforts and notified the BLM to suspend work on the related NEPA analysis.

Paris Hills Project

Historical exploration and development activities were as follows within the PH Project area:

- Paris Canyon/McIlwee Mine:
 - 1913 - phosphate exploration work began in Paris Canyon.
 - 1915 - the first test shipments of phosphate rock were sent to Los Angeles, California and to Anaconda, Montana.
 - By 1925 – total underground workings consisted of 3,000 ft of tunnels, drifts, winzes, & crosscuts and a 300 ton per day (tpd) mill. No estimates of total production are available.
 - 1942 and 1943 – Wyodak advanced 725 ft of underground workings.
- Consolidated/Little Canyon Mine:
 - 1903 – A 150-acre placer claim was filed in Little Canyon.
 - 1908 – 1915 – Three prospectors explore for phosphate on three lode mining claims in Little Canyon. The work consists of several open cuts and short tunnels on the claims.
 - 1930 to 1932 - Solar installed an inclined shaft 200 ft deep and two lateral drifts with a total of 3,500 ft of underground workings.
 - 1942 and 1943 – Wyodak advanced 500 ft of underground workings.
- Bloomington Canyon Mine:
 - Until the time of Wyodak's interest in the region, the area was little explored, or developed.
 - 1942 and 1943 - Wyodak advanced 1,200 ft of underground workings.
 - 1972 to 1973 – ESI drove approximately 900 ft of workings to sample for vanadium.
 - 1975 – ESI drove 2,700 ft of workings in the UPZ for bulk metallurgical sampling. Approximately 42,000 tons of phosphate rock and overburden were mined.
 - 1972 to 1977 – ESI drilled 47 rotary and core holes.
 - 1974 to 1977 – metallurgical testing was conducted by ESI to determine processing methods for producing both phosphate and vanadium products. Approximately 20,000 tons of rock was shipped to the Stauffer plant in Lefe, Wyoming. After early results the trial was suspended.
- Bear Lake Mine:
 - 1914 – 1921 – Various owners mined 1,200 ft of main development drift and double-track and 1,500 ft of drifts, raises and crosscuts.

During World War II, interest in the Paris-Bloomington phosphate deposits was renewed as a potential source of vanadium. Early work in the Consolidated/Little Canyon and Paris Canyon Mines had noted the presence of vanadium in the phosphate beds. Vanadium became an important strategic material supporting the war effort and extensive areas of public land in the western phosphate deposits that contained vanadium were withdrawn. The USGS began exploration in the Paris-Bloomington area in 1942.

In 1943, the Reconstruction Finance Corporation (RFC) assigned the task of developing the vanadium deposit to its sub-agency, the MRC. The MRC then contracted with Wyodak (a subsidiary of Homestake Mining Company) as the agent to conduct exploration, development, and operation. Work was focused on the Paris Canyon, Consolidated/Little Canyon and Bloomington Canyon Mines. Work was stopped by MRC as the shortage of vanadium was satisfied from other sources.

RMP became interested in the PH Project in 2007 and sampled the phosphate and vanadium beds in outcrop around the perimeter of the Property. By 2008, they had assembled a property position comprising of 2,115 acres, which included the sites of the former Consolidated, Bloomington Canyon, and Paris Canyon Mines. Later in 2008, RMP completed 6 reverse circulation (RC) drill holes on the southern end of the Property to test the results of the ESI drilling.

PHA acquired the holdings from RMP in 2009 and entered into five mineral lease agreements with private landowners bringing the Property position to approximately 2,500 acres. A drilling program commenced in 2010 and continued through 2012. A total of 85,250 ft was drilled in 85 holes, approximately 27,575 ft of which were cored. A mineral resource estimate was completed in 2012 as part of a Feasibility Study and NI 43-101 Technical Report using 33 holes for a lower phosphate zone (LPZ) estimate and 29 holes for an upper phosphate zone (UPZ) estimate. The LPZ was the focus of an underground mine plan and had a reserve estimate completed. The mine life was estimated at 19 years.

Metallurgical testing was conducted by Jacobs Engineering S.A. (Jacobs) in 2011 and 2012. Tests were conducted on composite core samples from the LPZ and UPZ. Jacobs' phosphoric acid pilot plant demonstrated that merchant grade phosphoric acid (MGA) and granular fertilizers could be produced from the LPZ material without washing. Testing of the UPZ determined that washing would be required to produce marketable phosphate rock.

A hydrogeologic investigation was completed for the 2012 FS, which involved packer permeability testing, 8 pairs of nested vibrating wire piezometers (VWPs), slug testing, and monitoring of field water quality parameters. A numerical groundwater model was prepared to predict groundwater flows, dewatering in advance of mining, and mine dewatering requirements. The regional hydrogeologic setting of the Southeast Idaho Phosphate District has been described in numerous reports and was relied upon to supplement the site-specific investigation. Predicted mine inflow increases with increasing depth of submergence as mining moves downdip to the north. Pumping rates were estimated to be 1,000 gallons per minute (gpm) in year 1 of mining, 12,500 gpm in year 4 and peaking at 16,500 gpm in year 12.

6.3 Historical Mineral Resource and Mineral Reserve Estimates

Rasmussen Valley Mine, Lanes Creek Mine, H1, and North Dry Ridge

In its Annual Information Form published February 22, 2017, Agrium, Inc. published the mineral resource and mineral reserve estimates shown on Table 6-1. Agrium's disclosure in the AIF related to the estimates is as follows:

"Towards the end of 2015, Agrium began mining from the Lanes Creek Mine in conjunction with mining at the North Rasmussen Ridge Mine. ... There were no further updates to the Rasmussen Valley Reserve estimate, therefore the final 2014 estimate of 10.1 million tonnes remains in place. Agrium's updated total Mineral Reserves for [Itafos Conda] are summarized in the Total Reserve Estimates table below. The Total Resource Estimates table is a summary for [Itafos Conda] only." [Bracketed text added for clarification].

Table 6-1: Historical Mineral Resource and Reserves Estimates for Itafos Conda Projects

The table below summarizes the mineral reserves estimates regarding CPO as at December 31, 2016:

Mining Operation	Ore Tons (metric) ⁽¹⁾	% P ₂ O ₅	Mine Life (years) ⁽²⁾
CPO Proven & Probable Reserves	15,133,952	25.0	7.0

Notes:

- (1) The concentration of recoverable mined ore tonnes 2.17 million wet tonnes mined to 1.30 million dry tonnes of beneficiated rock at 29.7 percent P₂O₅ is 59.9 percent for CPO (three-year running averages). This includes 0.08 and 0.36 million tonnes of Monsanto/P4 ore that was beneficiated during 2015 and 2016, respectively.
- (2) Estimates are based upon proven and probable reserves and average annual mining rates of approximately 2.15 million tonnes for CPO.

The table below summarizes the mineral resources estimates regarding CPO as at December 31, 2016:

Mining Operation	Resource Classification	Ore Tons (metric)	% P ₂ O ₅	Mine Life (years)
CPO	Inferred	18,000,000	25.10	7.3

Notes:

- (1) Mineral reserves are not included in mineral resource estimates.

Note - "CPO" refers to Conda Phosphate Operations.

Source: Agrium Inc., Annual Information Form (AIF), Year Ended December 31, 2016, p. 50, (February 22, 2017).

The QP has not done sufficient work to classify the historical estimate as current mineral resources or mineral reserves; and Itafos is not treating the historical estimate as current mineral resources or mineral reserves.

Based on the information in the AIF, it is impossible to accurately determine the location of the historical mineral resources and mineral reserves stated by Agrium.

The source and date of the historical estimates, including any existing technical report is the Agrium Inc., Annual Information Form, Year Ended December 31, 2016, p. 50, (February 22, 2017). No technical report was found supporting these estimates.

The relevance and reliability of the historical estimates are impossible to determine because there is no technical report or other supporting information available to the QP. For this reason, the QP cannot provide the key

assumptions, parameters, and methods used to prepare the historical estimates, and it is not possible to state whether the historical estimate uses categories other than the ones set out in NI 43-101 Items 1.2 and 1.3, nor to include an explanation of the differences.

More recent estimates or data available to Itafos are stated in this report in Item 14.0 and Item 15.0. The work done to upgrade the historical estimate as current is described in this Technical Report.

Paris Hills Project

Stonegate Agricom Ltd. filed on SEDAR a Technical Report dated July 8, 2013, titled “Amended and Restated NI 43-101 Technical Report, Paris Hills Phosphate Project, Bloomington, ID, USA,” with an Effective Date of January 18, 2013. This 2013 Technical Report is no longer current. Current mineral resource estimates for the PH Project are stated in Item 14.0 of this Technical Report.

6.4 Production from the Property

Rasmussen Valley Mine

Itafos has conducted open-pit mining from the RVM since January 2018 and total phosphate ore production has been approximately 925,000 tons.

Lanes Creek Mine

At LCM, Alumet developed an open pit mine in 1978, which was in operation until 1988, or 1989. However, Alumet’s operations removed only the upper portion of the LCM deposit and reportedly produced very modest tonnages. From 1978 to 1984, an estimated 77,000 tons of phosphate ore was produced from LCM.

Agrium commenced production in 2015. Itafos currently mines the LCM lease as part of their ongoing phosphate operations. Since 2015, Agrium and Itafos had a total phosphate rock production from LCM of approximately 2.0 Mt.

Currently, the phosphate ore is transported via haul truck to the WV Tipple (rail loadout facility) then shipped by rail to the Conda Phosphate Plant.

H1 and North Dry Ridge

No production has occurred on the H1 and NDR leases.

Paris Hills

Historical production from the PH Project area were from the following small-scale underground developments.

- Paris Canyon/McIlwee Mine:
 - 1917 - the mine became the second producing phosphate mine in ID with the first shipment of ore.
 - Up to 1920 – approximately 60,000 tons of phosphate ore was produced.
- Consolidated/Little Canyon Mine:
 - 1930 - 1932 - Solar mined and shipped a few thousand tons of phosphate ore to the Consolidated facility in Trail, British Columbia where it was beneficiated and processed into a “finished triple superphosphate

fertilizer product.” In the first two months of 1932, 3,500 tons were shipped to Trail. No subsequent record of shipments is available.

- Bloomington Canyon Mine:
 - Except for the bulk samples described earlier, no production occurred from this mine.
- Bear Lake Mine:
 - 1920 – 1923 – Various owners shipped small amounts of phosphate ore from the underground development workings for processing in California and locally.

From the information available, all historical production from the mines in the PH Project area was from the UPZ. There has been no production to date from the LPZ. See Item 7 discussion of the PH Project geology and mineralization for additional information on the UPZ and LPZ.

7.0 GEOLOGICAL SETTING AND MINERALIZATION

This Item contains forward-looking information related to **regional and local geology, as well as mineralization** for the Project. The material factors that could cause actual results to differ materially from the conclusions, estimates, designs, forecasts, or projections in the forward-looking information include any significant differences from one or more of the following material factors or assumptions that were applied in drawing the conclusions or making the estimates, designs, forecasts, or projections set forth in this Item.

7.1 Regional Geology

Stratigraphy

The Itafos Conda LLC and Paris Hills Agricom Inc. properties lie within the Rocky Mountain Physiographic Province in southeastern Idaho, United States of America, see Figure 7-1. The geologic units within the study area are generally marine sedimentary deposits that range from Pennsylvania to recent in age. The Phosphoria Formation contains the phosphatic beds that form the basis for this current investigation into phosphate mineralization at the Project deposits.

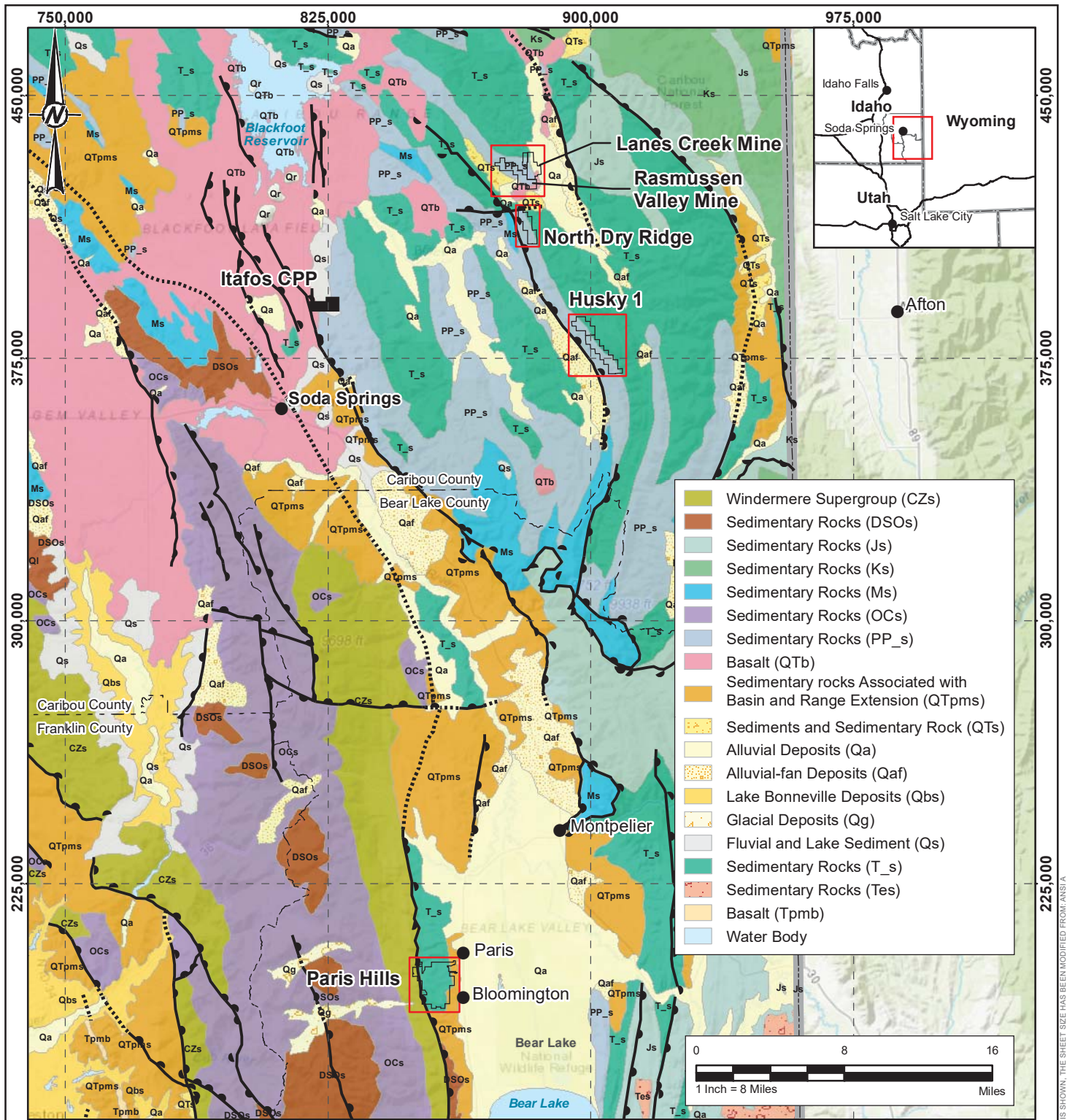

LEGEND

- Project Map Extents
- State Boundary
- County Boundary
- Fault
- Fault Concealed
- Itafos CPP

REFERENCE(S)

1. COORDINATE SYSTEM: NAD 1983 STATE PLANE IDAHO EAST FIPS 1101 FEET
2. DATA PROVIDED BY ITAFOS CONDA LLC
3. GEOLOGY DATA FROM IDAHO GEOLOGICAL SURVEY

CLIENT
ITAFOS CONDA LLC

PROJECT
NI 43-101 TECHNICAL REPORT FOR CONDA PHOSPHATE OPERATIONS

TITLE
REGIONAL GEOLOGY MAP

CONSULTANT	YYYY-MM-DD	2019-07-18
DESIGNED	-	
PREPARED	EFT	
REVIEWED	DW	
APPROVED	JD	



PROJECT NO.	CONTROL	REV.	FIGURE
18114499	0001	-	7-1

1 in IF THIS MEASUREMENT DOES NOT MATCH WHAT IS SHOWN, THE SHEET SIZE HAS BEEN MODIFIED FROM: ANSIS/A

A detailed list of the stratigraphic units of the area are described below in reverse stratigraphic order and in Figure 7-2.

Alluvium/Colluvium – Quaternary

Unconsolidated sand, silt, and gravel in drainages and along hillsides that averages 0-60 feet in thickness.

Basalt – Quaternary

Dark grey olivine basalt that averages 0-150 feet in thickness.

Salt Lake Formation – Tertiary, only found in Paris Hills Region

White, grey, and green tuff, calcareous siltstone, sandstone, and conglomerates that averages 0-65 feet in thickness.

Wasatch Formation – Tertiary, only found in Paris Hills Region

Variiegated red to grey mudstone and/or clay, fine to coarse-grained brown to grey sandstone, conglomeritic lenses or quartzite, chert, and minor limestone pebbles that averages 15-300 feet in thickness.

Thaynes Formation – Triassic, only found in Paris Hills Region

Gray limestone and brown-weathered grey calcareous siltstone; dark grey to olive drab finely laminated shale, and interbedded limestone abundant in the lower portion. The formation averages 0-410 feet in thickness.

Dinwoody Formation – Triassic

Composed of interbedded grey limestone that grades downward into calcareous shale and siltstone with thin limestone interbeds. Surficial weathering of the Dinwoody Formation forms dense, clayey soils. Forms rounded slopes in outcrops. The formation averages 1,700-2,200 feet in thickness.

Phosphoria Formation – Permian

The Phosphoria Formation is split into three members. In reverse stratigraphic order they are: Cherty Shale, Rex Chert, and Meade Peak Phosphatic Shale.

The Cherty Shale Member averages 100-200 feet in thickness and comprises thinly bedded dark brown to black, cherty mudstone, siliceous shale, and argillaceous chert.

The Rex Chert Member is composed of thick-bedded black to bluish-white or occasionally reddish-brown chert with small amounts of interbedded mudstone and lenticular limestone. The member is resistant to weathering and crops out along prominent ridges that form marker beds across the region. The Rex Chert Member averages 30-80 feet in thickness.

The Meade Peak Phosphatic Shale Member (Meade Peak) is the host of the phosphate mineralization in the Southeast Idaho Phosphate District. The Meade Peak Member was deposited in an interior marine basin that extended across parts of Idaho, Utah, Wyoming, and southwestern Montana. The basin had a maximum depth of 1,000 ft to 1,600 ft and was an area of moderate to intense water upwelling, which brought cold, nutrient-rich water to the surface, causing increased algal and plankton productivity. The resulting steady rain of organic debris on the paleo seafloor was the source of the high-grade phosphorite deposits (Hein, J. R., McIntyre, B. R., Perkins,

R. B., Piper, D. Z., & Evans, J. G. , 2004), (Hein, J. R. , 2004) (Piper, D. Z., & Link, P. K., 2002), (Moyle, P. R., & Piper, D. Z. , 2004)).

The Meade Peak Member averages 200 feet in thickness across the region where approximately 50 feet comprises two phosphatic mineralized zones and the remaining thickness comprises unmineralized interburden material. Further discussion on the phosphate mineralized zones is presented later in this Item.

Grandeur Member of the Park City Formation – Pennsylvanian

Massive to thickly bedded grey dolomite that is occasionally sandy or argillaceous and may be recrystallized and averages 65-100 feet in thickness.

Wells Formation – Pennsylvanian

The upper member of the Wells Formation averages 2,200-2,400 feet thick and consists of buff colored sandy limestone, grey to reddish brown sandstone, dolomitic limestone, and interbedded grey limestone and dolomite. The lower member of the Wells Formation averages 850-950 feet thick and consists of medium-bedded, grey, cherty limestone with some interbedded sandstone.

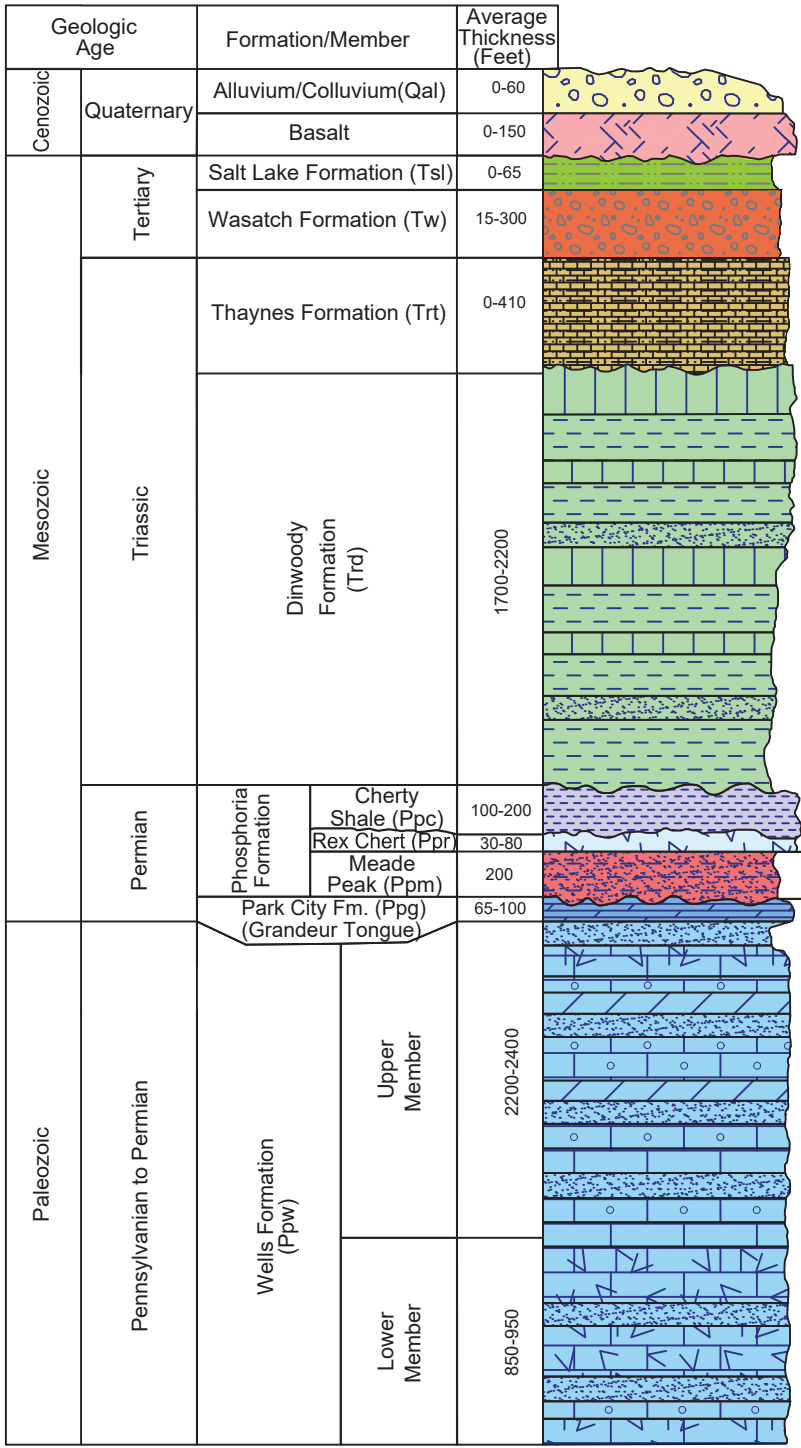

Meade Peak Member

Average Thickness (Feet)	Description
15-35 ft	Hanging Wall Mud
~15 ft	Upper Phosphate Zone - Low/Medium to High Grade (Interbedded Phosphorite Mudstone, Siltstone, Limestone, and Shale)
80-110 ft	Center Interburden - Mudstone and Shale
~40 ft	Lower Phosphate Zone - Low to High Grade (Interbedded Phosphorite Mudstone, Siltstone, Limestone, and Shale)
5-10 ft	Footwall Mud

NOT TO SCALE

CLIENT		
ITAFOS CONDA LLC		
PROJECT		
NI 43-101 TECHNICAL REPORT FOR CONDA PHOSPHATE OPERATIONS		
TITLE		
TYPICAL REGIONAL STRATIGRAPHIC COLUMN		
CONSULTANT	YYYY-MM-DD	2019-11-19
	DESIGN	EFT/WJS
	PREPARED	EFT/WJS
	REVIEW	DW
	APPROVED	JD



REFERENCE(S)
1.) SOURCE: 2012 Geologic Baseline Report, Brown and Cadwell

PROJECT NO. 18114499 PHASE 0001 Rev **A** FIGURE 7-2

PATH: C:\drafting\autocad\A-Portrait_2015.dwg

Structural Geology

The structural geology of the region is characterized by subparallel folded mountain ranges separated by thinly filled valleys (Mabey, Don R. and Oriel, Steven S., 1970); (Fenneman, Nevin M., January 1917). The northwest trending thrust faults, folds, and large-displacement tear faults perpendicular to the fold axis in the region were formed by compressional forces during the late Cretaceous, specifically during the Sevier Orogeny. Later, high-angle normal faults associated with horst and graben structures were mostly formed during Basin and Range extension during the Miocene, approximately 17 Million years ago. The resulting structural features of the compression and extension generally trend northwest-southeast and have disrupted the originally flat-lying strata to be folded and faulted.

7.2 Itafos Conda Projects Geology

The local and project geology of the deposits of the Itafos Conda projects are generally similar in that they are structurally dominated by a series of northwest / southeast trending anticlines and synclines with thrust and normal faults disrupting the strata.

The Meade Peak Member of the Phosphoria Formation contains the phosphate ore within the Conda Projects and is overlain by the Rex Chert member and underlain by the Park City Formation. The Quaternary Alluvium is not very extensive and where present, is only about 5 ft to 20 ft thick.

The Meade Peak Member is broken into five mining zones throughout the Conda Projects where the Upper Phosphate and Lower Phosphate Zones are the primary phosphate mineralized zones. The significant mineralized zones encountered on the property are shown below:

- Upper Overburden Zone (Hanging Wall mud).
- Upper Phosphate Zone - Low/medium to high grade phosphate zone. Interbedded phosphorite, mudstone, siltstone, limestone, and shale.
- Center Interburden Zone – Shale and mudstone.
- Lower Phosphate Zone – Low to high grade phosphate zone. Interbedded phosphorite, mudstone, siltstone, limestone, and shale.
- Lower Underburden Zone (Footwall mud) – Reddish brown siltstone with black fossiliferous siltstone and some phosphorite.

The mean thickness of the mineralized zones within the Conda Projects are shown in Table 7-1.

Table 7-1: Conda Projects Mineralized Zone Average Thicknesses

Mining Zone	Bed Name	Phosphate Grade	Average Thickness (Feet) ¹							
			RVM		LCM		NDR		H1	
			Bed	Zone	Bed	Zone	Bed	Zone	Bed	Zone
Hanging Wall Mud		-	20.29	20.29	31.67	31.67	21.78	21.78	32.37	32.37
Upper Phosphate Zone	D1	High	3.33	21.69	4.10	19.41	2.70	21.77	4.51	30.46
	D2 Parting	-	2.29		1.42		2.17		3.67	
	D3	High	3.28		2.13		3.49		5.43	
	D4 Parting	-	1.75		1.58		2.09		3.48	
	Upper Interbed	Medium	3.96		2.31		3.57		4.81	
	D5-1	Low-Medium	3.46		4.36		4.17		3.93	
	D5-2	Low-Medium	3.61		3.50		3.58		4.64	
Center Interburden	Upper Center Interburden	-	96.65	106.32	81.26	81.26	105.44	105.44	111.87	111.87
	F Marker Bed	-	4.70							
	Lower Center Interburden	-	4.98							
Lower Phosphate Zone	C	Low-Medium	-	33.16	9.274	40.07	6.78	38.85	7.15	50.19
	False Cap	-	6.26		7.67		6.59		9.54	
	Upper B	Medium-High	4.27		5.10		6.05		5.80	
	B Parting	-	3.12		1.44		2.61		3.27	
	Lower B	Medium-High	6.59		5.35		5.92		7.00	
	HC	-	3.60		-		-		-	
	A Cap	Low-Medium	3.84		6.03		6.05		10.06	
	A Bed	High	5.48		5.20		4.85		7.37	
Footwall Mud		-	5.92	5.92	4.46	4.46	5.54	5.54	7.75	7.75

Note:

¹ Values in table are average true thicknesses within resource estimation limits

RVM and LCM Structural Geology

The Snowdrift Anticline is the geologic structure that defines the RVM and LCM strata. The Snowdrift Anticline is a northwest-southeast trending anticline that plunges gently southeast. RVM is located on the southwest limb and the LCM is located on the northeast limb of the anticline, see Figure 7-3. The Snowdrift Anticline formation caused the flat lying beds of the Phosphoria Formation to be altered so that they strike northwest/southeast and plunge southwest within the RVM and plunge northeast within the LCM, as shown in the Figure 7-4. Both limbs of the anticline are very steep where the beds are near vertical or overturned. The strata of the Phosphoria Formation outcrop along the limbs of the anticline.

The Snowdrift Anticline is bound on the east by the Lanes Creek Fault, which dips at 83 degrees east with approximately a 400 foot normal displacement, and on the west by the Enoch Valley Fault, which is a normal fault that dips at 80 degrees west and can have up to 3,000 feet of displacement. The Rasmussen Fault strikes east west and intersects the Snowdrift Anticline axis north of the RVM and LCM areas. The Rasmussen Fault has approximately 4,000 feet of left-lateral displacement and truncates the Phosphoria Formation in the RVM and LCM areas.

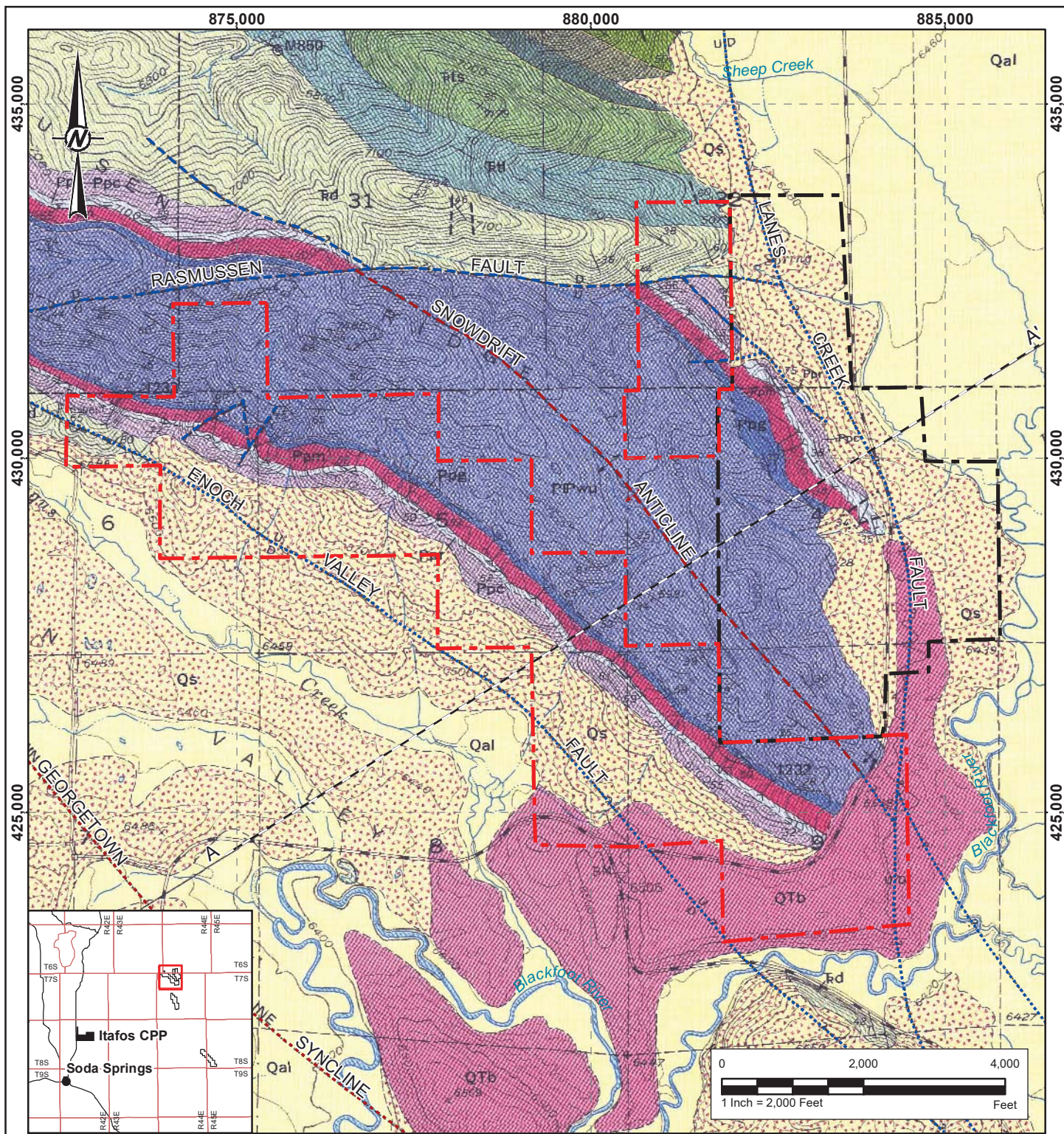

LEGEND

- - - RVM Lease Boundary
- - - LCM Lease Boundary
- Cross-Section (A - A')
- - - Anticline - Inferred
- - - Syncline - Concealed
- - - Contact - Inferred
- - - Contact - Concealed
- - - Thrust fault - Concealed

Description of Map Units

Qal	Alluvium
Qs	Surficial Deposits
QTb	Basalt
Tpl	Lower part of the Portneuf Limestone Member
Nm	Nodular Siltstone Member
Blsh	Black Shale Member
Pls	Platy Siltstone Member
Blm	Black Limestone Member
Dw	Dinwoody Formation
Csm	Cherty Shale Member
Rxc	Rex Chert Member
Mps	Meade Peak Phosphatic Shale Member
Gt	Grandeur Tongue of Park City Formation
Uw	Upper Member of the Wells Formation

REFERENCE(S)

1. COORDINATE SYSTEM: NAD 1983 STATE PLANE IDAHO EAST FIPS 1101 FEET
2. DATA PROVIDED BY ITAFOS CONDA LLC
3. GEOLOGY BASED FROM U.S. GEOLOGICAL SURVEY GEOLOGIC MAP OF THE UPPER VALLEY QUADRANGLE, CARIBOU COUNTY, IDAHO 1975

CLIENT
ITAFOS CONDA LLC

PROJECT
NI 43-101 TECHNICAL REPORT FOR CONDA PHOSPHATE OPERATIONS

TITLE
RASMUSSEN VALLEY MINE AND LANES CREEK MINE LOCAL GEOLOGY MAP

CONSULTANT

YYYY-MM-DD 2019-11-22

DESIGNED -

PREPARED EFT

REVIEWED DW

APPROVED JD



PROJECT NO.
18114499

CONTROL
0001

REV.
-

FIGURE
7-3

IF THIS MEASUREMENT DOES NOT MATCH WHAT IS SHOWN, THE SHEET SIZE HAS BEEN MODIFIED FROM: ANSI/A

Figure 7-4: Regional Cross Section, Snowdrift Anticline

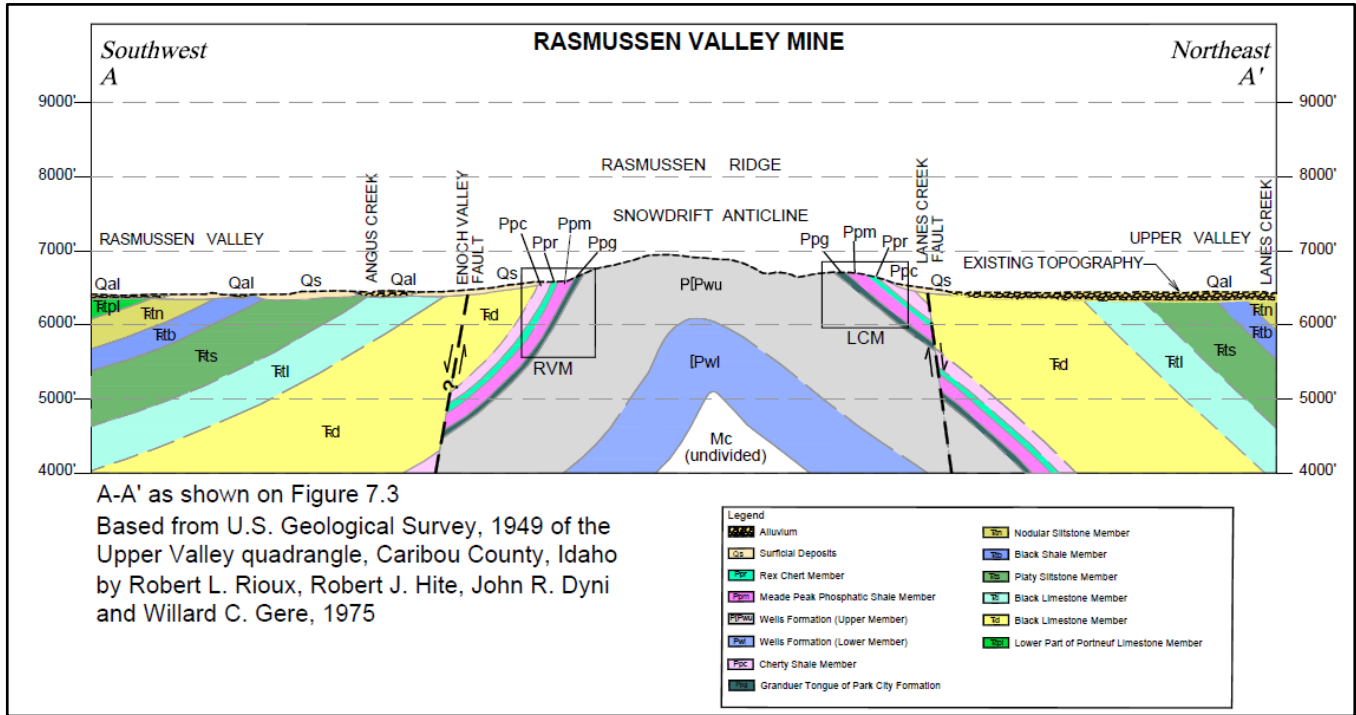

NDR and H1 Structural Geology

The structural feature that dominates the NDR and H1 areas is the northwest trending North Dry Valley Anticline. NDR and H1 are located on the northeast limb of the anticline and as such, the strata of NDR and H1 dips very steeply to near vertical to the northeast, see Figure 7-5 and Figure 7-6.

Faulting in the northern portion of the NDR lease has forced the Meade Peak Member of the Phosphoria Formation to uplift to the overlying Dinwoody Formation. This has resulted in the absence of the Meade Peak Member north of the Blackfoot normal fault with in the NDR property.

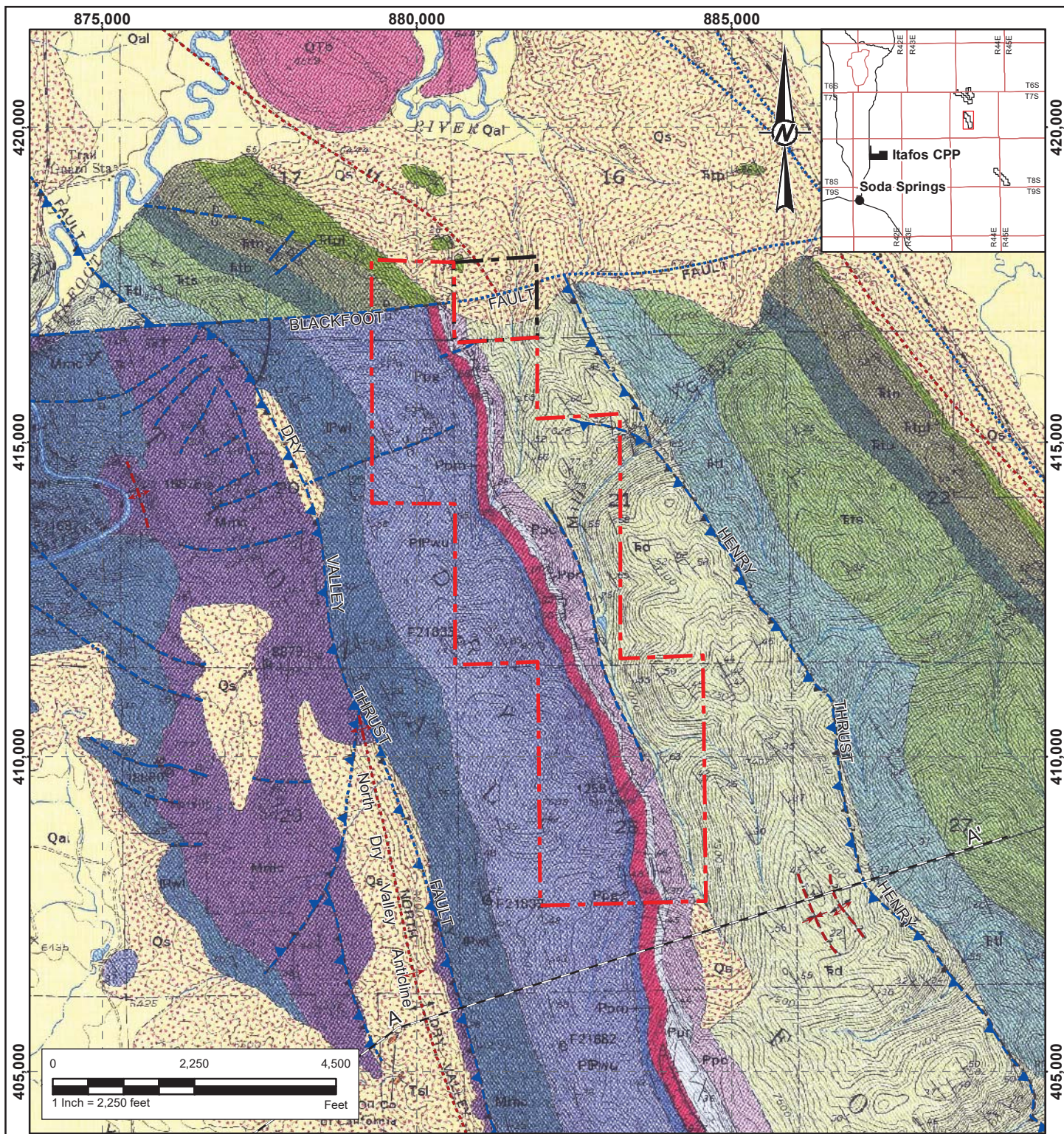

LEGEND

- North Dry Ridge Lease Boundary
- North Dry Ridge State Lease
- Cross-Section (A - A')
- Anticline - Inferred
- Anticline - Concealed
- Syncline - Inferred
- Syncline - Concealed
- Contact - Approximate
- Contact - Inferred
- Contact - Concealed
- Thrust fault - Inferred
- Thrust fault - Concealed

Description of Map Units

- Surficial Deposits
- Lower part of Portneuf Limestone Member
- Nodular Siltstone Member
- Black Shale Member
- Platy Siltstone Member
- Black Limestone Member
- Dinwoody Formation
- Cherty Shale Member
- Rex Chert Member
- Meade Peak Phosphatic Shale Member
- Grandeur Tongue of Park City Formation
- Upper Member of the Wells Formation
- Lower Member of the Wells Formation
- Monroe Canyon Limestone

REFERENCE(S)

1. COORDINATE SYSTEM: NAD 1983 STATE PLANE IDAHO EAST FIPS 1101 FEET
2. DATA PROVIDED BY ITAFOS CONDA LLC
3. GEOLOGY BASED FROM U.S. GEOLOGICAL SURVEY GEOLOGIC MAP OF THE UPPER VALLEY QUADRANGLE, CARIBOU COUNTY, IDAHO 1975

CLIENT
ITAFOS CONDA LLC

PROJECT
NI 43-101 TECHNICAL REPORT FOR CONDA PHOSPHATE OPERATIONS

TITLE
NORTH DRY RIDGE PROPERTY LOCAL GEOLOGY MAP

CONSULTANT		YYYY-MM-DD	2019-11-22
DESIGNED		-	
PREPARED		EFT	
REVIEWED		DW	
APPROVED		JD	

PROJECT NO.	CONTROL	REV.	FIGURE
18114499	0001	-	7-5



IF THIS MEASUREMENT DOES NOT MATCH WHAT IS SHOWN, THE SHEET SIZE HAS BEEN MODIFIED FROM: ANSI/A 11 in

Figure 7-6: Regional Cross Section, North Dry Valley Anticline, North Dry Ridge

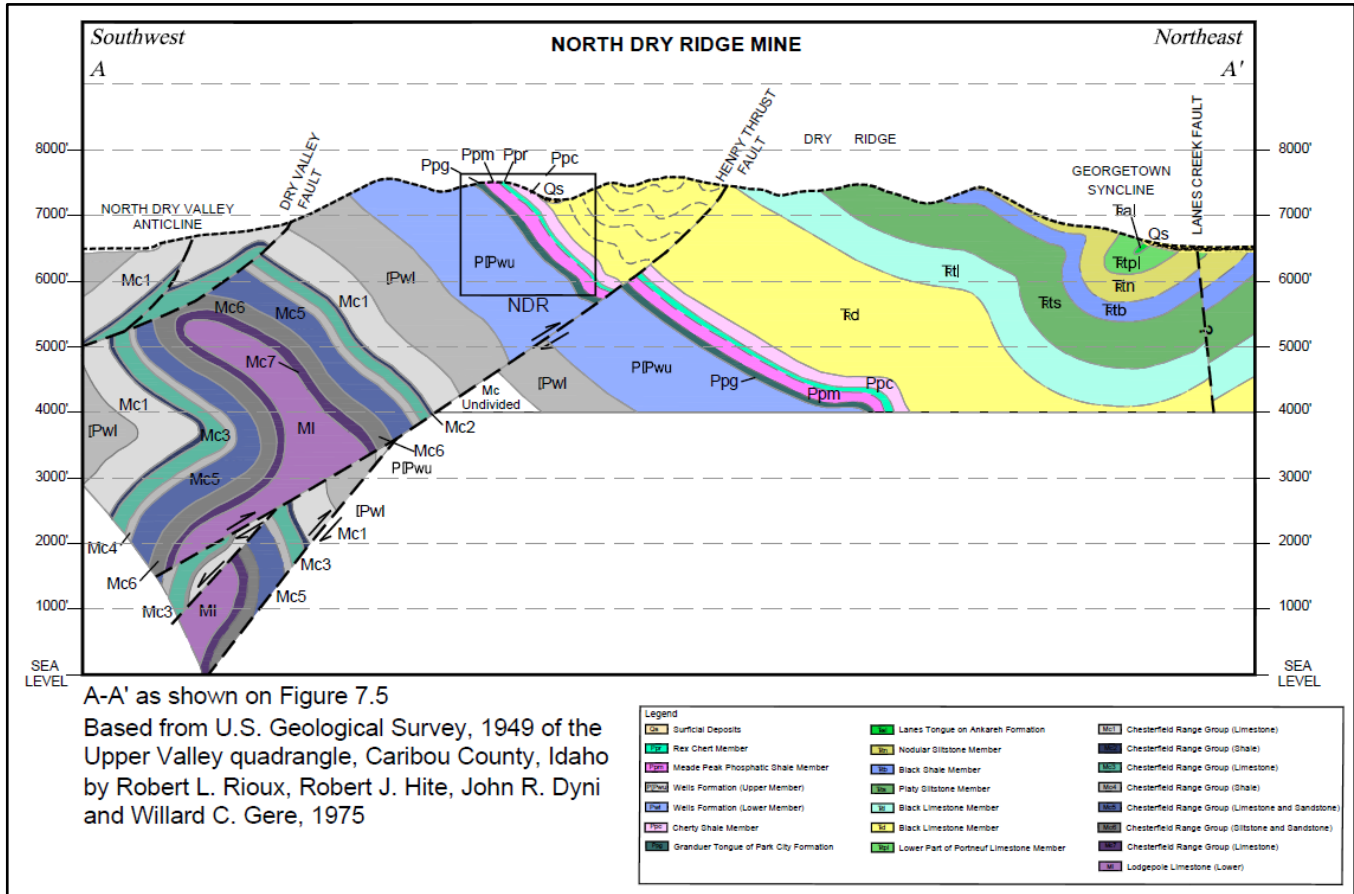

Note: The Henry Thrust Fault as depicted in the 1949 USGS map appears to exhibit normal rather than reverse displacement; however, Golder has maintained the USGS section and fault naming and has not made revisions as there is no material impact on the study based on this potential discrepancy.

Additional folding and faulting are found in the southern portion of the H1 area, notably, the Stewart Anticline, which trends northeast/southeast. The axis of the Stewart Anticline are within the southern portion of the H1 property and allow for a large outcrop area of the Meade Peak Member, see Figure 7-7 and Figure 7-8.

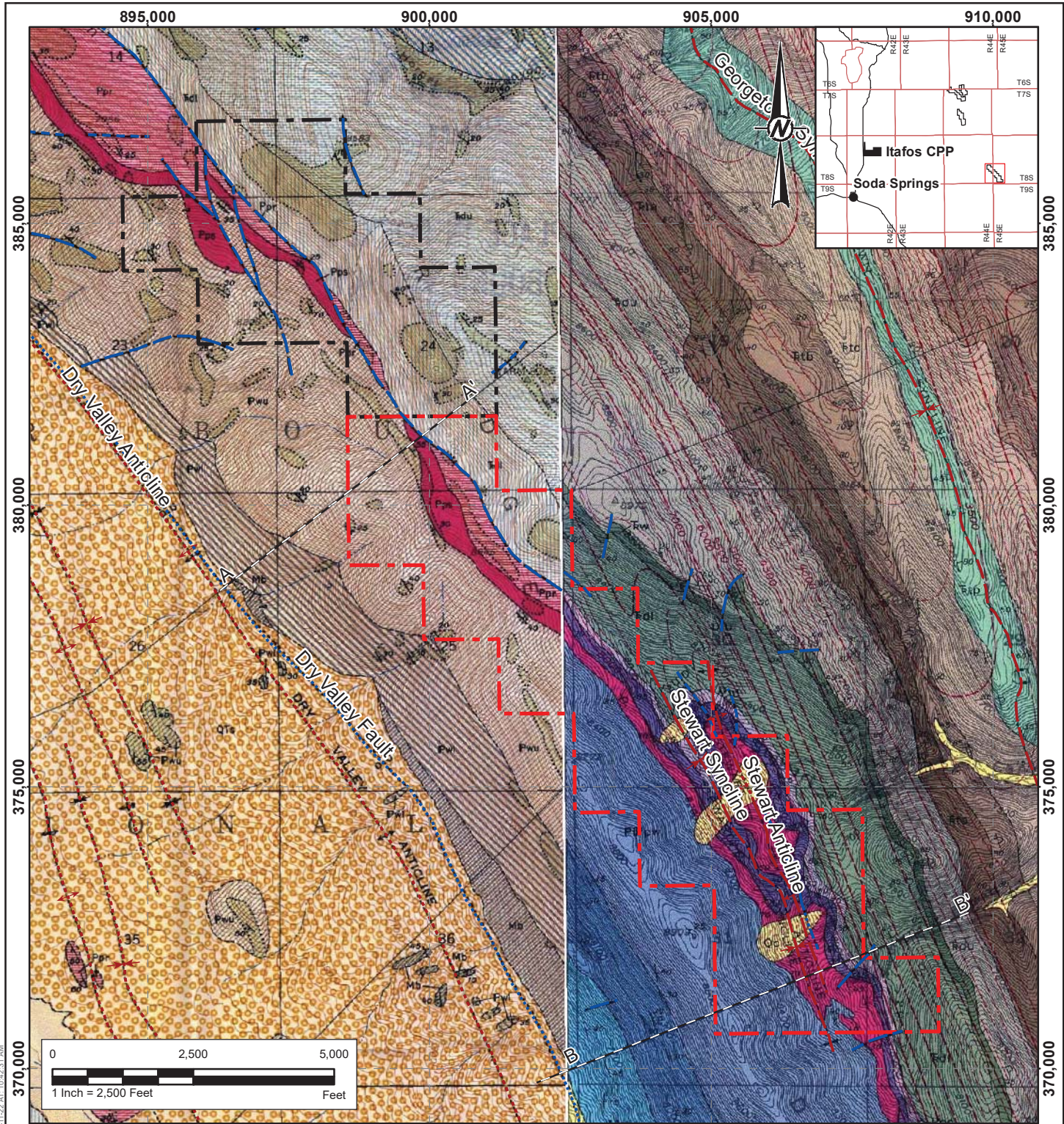

PATH: P:\Husky\Conda\18114499\GIS\MapF\Fig7.7_Husky1_Geology.mxd PRINTED ON: 2019-11-22 AT: 10:42:31 AM
 1 in

IF THIS MEASUREMENT DOES NOT MATCH WHAT IS SHOWN, THE SHEET SIZE HAS BEEN MODIFIED FROM: ANSI/A

LEGEND

- ▬ H1 Lease Boundary
- ▭ H1 KPLA
- Cross-Section (A - A')
- ⋈ Anticline - Approximate
- ⋈ Anticline - Concealed
- ⋈ Syncline - Approximate
- ⋈ Syncline - Concealed
- Contact - Approximate
- - Contact - Inferred
- ⋯ Contact - Concealed

Description of Map Units

- Alluvium
- Surficial Deposits
- Sedimentary Deposits
- Portneuf Limestone Member
- Tongue of Woodside Shale
- Thaynes Formation A Member
- Thaynes Formation B Member
- Thaynes Formation C Member
- Upper Member of Dinwoody Formation
- Lower Member of Dinwoody Formation
- Cherty Shale Member
- Rex Chert Member
- Meade Peak Phosphatic Shale Member
- Grandeur Tongue of Park City Formation
- Lower Member of the Wells Formation

REFERENCE(S)

1. COORDINATE SYSTEM: NAD 1983 STATE PLANE IDAHO EAST FIPS 1101 FEET
2. DATA PROVIDED BY ITAFOS CONDA LLC
3. GEOLOGY BASED FROM U.S. GEOLOGICAL SURVEY GEOLOGIC MAP OF THE DRY VALLEY QUADRANGLE, CARIBOU COUNTY, IDAHO 1950-51, AND GEOLOGIC MAP OF THE STEWART FLAT QUADRANGLE, CARIBOU COUNTY, IDAHO 1956

CLIENT
ITAFOS CONDA LLC

PROJECT
NI 43-101 TECHNICAL REPORT FOR CONDA PHOSPHATE OPERATIONS

TITLE
HUSKY 1 PROPERTY LOCAL GEOLOGY MAP

CONSULTANT	YYYY-MM-DD	2019-11-22
DESIGNED	-	
PREPARED	EFT	
REVIEWED	DW	
APPROVED	JD	

PROJECT NO.	CONTROL	REV.	FIGURE
18114499	0001	-	7-7

Figure 7-8: Regional Cross Sections, North Dry Valley Anticline, H1

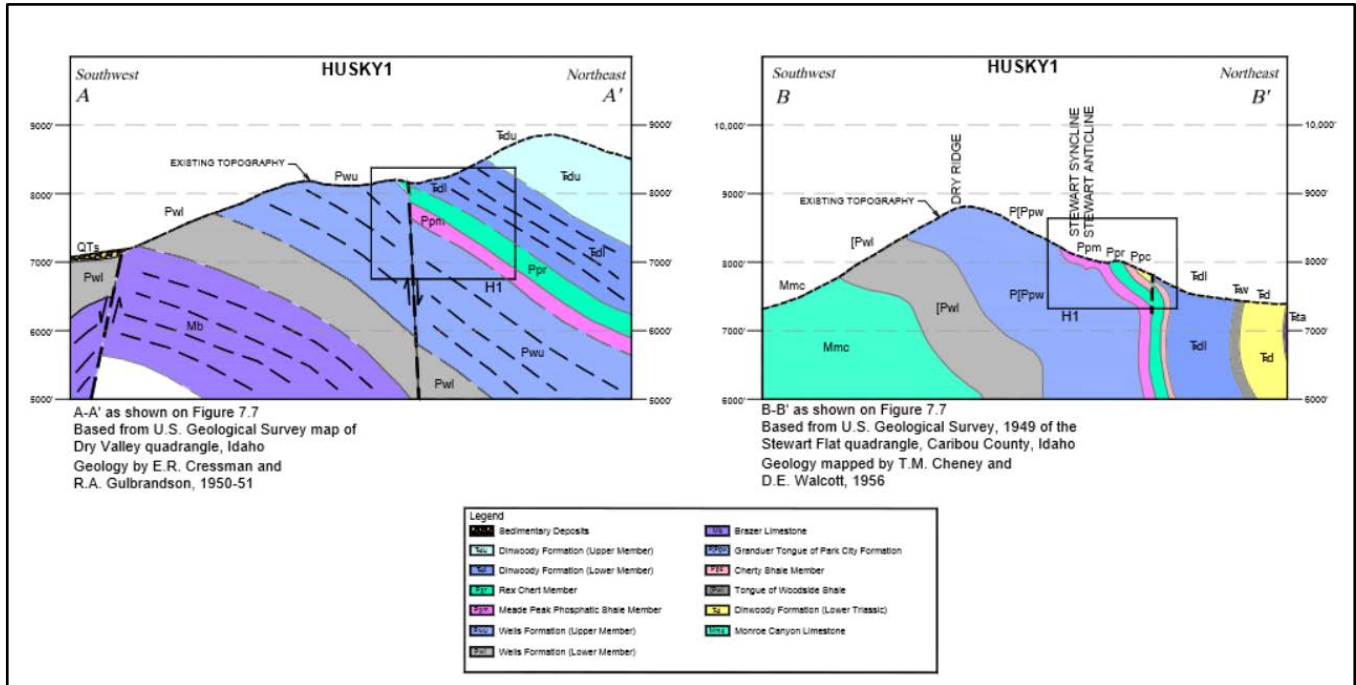

7.3 Paris Hills Project Geology

The local and Project geology of the PH Project is dominated by the north-south trending, north plunging Paris Syncline (Service 1966), as shown on Figure 7-9 and Figure 7-10. The axis of the Paris Syncline is in the western portion of the PH Project. The strata on the western limb of the syncline is upturned and steeply dipping whereas the eastern limb is gently dipping to the west.

The major fault areas within the PH Project include:

- Spring Wash Fault Zone in the north
- West Bear Lake Fault Zone in the east
- Sage Hills Fault Zone near the middle
- Consolidated Fault Zone in the west

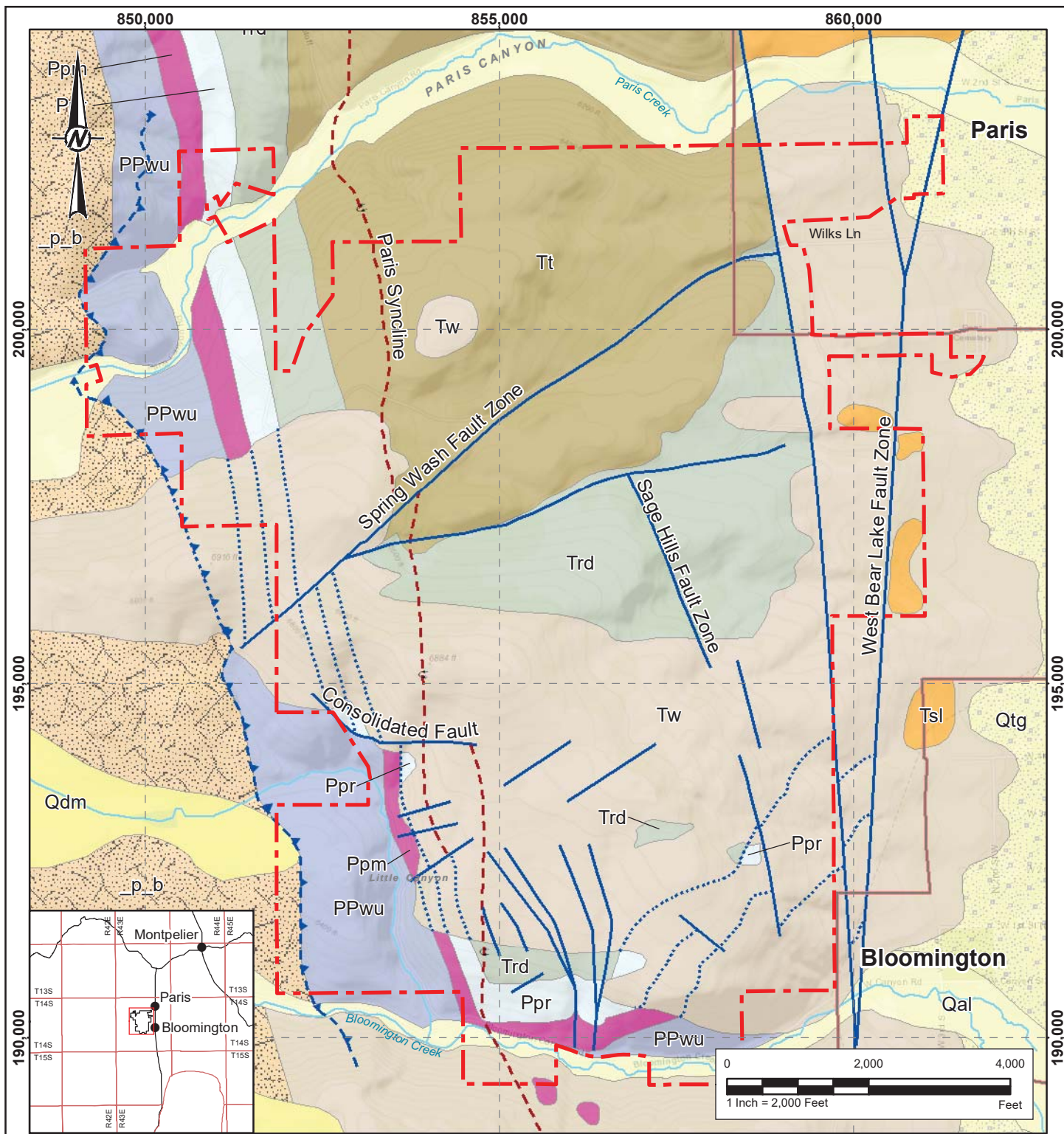

- LEGEND**
- Paris Hills Mine Boundary
 - City/Town
 - Alluvium
 - Terrace Gravels
 - Diamicton
 - Salt Lake Formation
 - Wasatch Formation
 - Thaynes Formation
 - Dinwoody Formation
 - Rex Chert Member of the Phosphoria Formation
 - Meade Peak Member of the Phosphoria Formation
 - Wells Formation
 - Brigham Quartzite
 - River/Stream
 - Contact - Concealed
 - Surface Fault Expression
 - Thrust Fault - Approximate
 - Thrust Fault - Concealed
 - Axis of Overturned Syncline

REFERENCE(S)
 1. COORDINATE SYSTEM: NAD 1983 STATE PLANE IDAHO EAST FIPS 1101 FEET
 2. DATA PROVIDED BY ITAFOS CONDA LLC

CLIENT
ITAFOS CONDA LLC

PROJECT
NI 43-101 TECHNICAL REPORT FOR CONDA PHOSPHATE OPERATIONS

TITLE
PARIS HILLS LOCAL GEOLOGY MAP

CONSULTANT	YYYY-MM-DD	2019-11-22
DESIGNED	-	
PREPARED	EFT	
REVIEWED	DW	
APPROVED	JD	

PROJECT NO.	CONTROL	REV.	FIGURE
18114499	0001	-	7-9



IF THIS MEASUREMENT DOES NOT MATCH WHAT IS SHOWN, THE SHEET SIZE HAS BEEN MODIFIED FROM: ANSI/A

Figure 7-10: Regional Cross Sections – Paris Hills

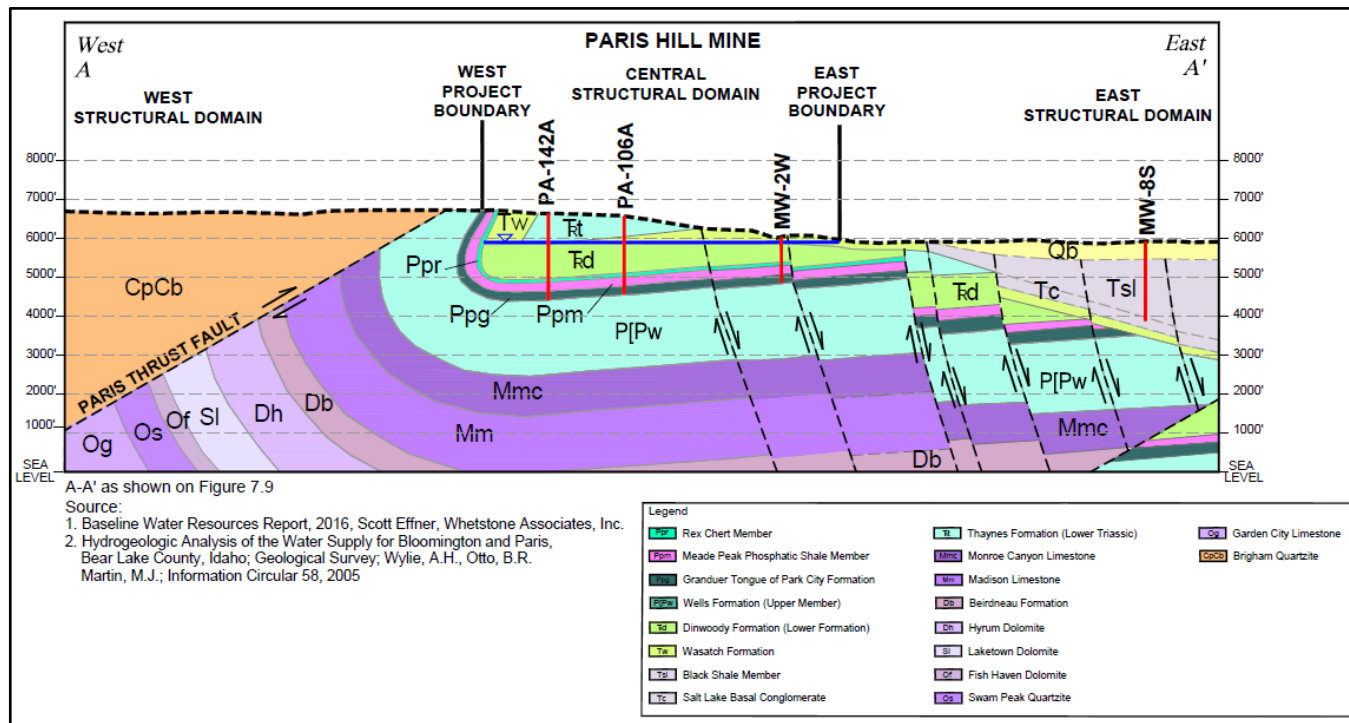

The Meade Peak Member is broken into five mining zones throughout the PH Project where the Upper Phosphate and Lower Phosphate Zones are the primary phosphate mineralized zones. The significant mineralized zones encountered on the property are shown below:

- Hanging Wall Mud
- Upper Phosphate Zone - Low/medium to high grade phosphate zone. Interbedded phosphorite, mudstone, siltstone, limestone, and shale
- Middle Interburden Zone - Shale and mudstone
- Lower Phosphate Zone – Low to high grade phosphate zone. Interbedded phosphorite, mudstone, siltstone, limestone, and shale.
- Footwall mud – Reddish brown siltstone with black fossiliferous siltstone and some phosphorite.

The individual beds identified in the UPZ and LPZ at the Itafos Conda projects are not clearly distinguished at the PH Project; the LPZ at PH comprises only the A Bed and a FWM bed, while the UPZ at PH comprises an undifferentiated D Bed that isn't broken out into the seven subunits observed at the Itafos Conda projects. The PH UPZ includes the HWM bed that overlies the undifferentiated D Bed.

Earlier studies for PH identified a potential vanadium enriched zone occurring at the base of the UPZ; however, the grade data used to identify this zone was from historical programs that predated the Paris Hills Agricom Inc. exploration work on the property. This exploration data did not include analyses for vanadium. The historical data did not meet the standards for data and methodology verification that were applied to the PH database and as

such were not considered reliable by Golder during preparation of the current Mineral Resource estimates for PH. This potential vanadium enriched zone represents an exploration target opportunity for further exploration evaluation but has not been identified as a specific unit in this current study nor have estimates of Mineral Resources been prepared for it.

Additionally, the western portion of the PH Project comprises a distinct structural domain where the structure of the deposit changes rapidly from a moderately dipping monoclinical sequence (dipping moderately to the NNE) to a rapidly steepening and eventually overturned sequence to the west. A limit polygon was applied to restrict modeling and estimation within the overturned limb due to a lack of available drilling and grade data; however, it is assumed based on surface mapping that the potential exists for the existence of both the LPZ and UPZ units in this domain. Similar to the potential vanadium zone discussed above, the overturned domain at PH represents an exploration target opportunity for further exploration evaluation but has not been modeled in this current study nor have estimates of Mineral Resources been prepared for it.

The mean thickness of the mineralized zones within the Paris Hills Project are shown in Table 7-2.

Table 7-2: Paris Hills Project Mineralized Zone Average Thicknesses

Mining Zone	Bed Name	Phosphate Grade	Descriptive Statistics, Thickness (Feet)	
			Average	Maximum
	Hanging Wall Mud	-	18.98	39.22
Upper Phosphate Zone	UPZ or D	High	12.32	26.50
	D Parting	-		
	D1	High		
	D1 Parting	-		
	D Lower	Medium		
Center Interburden	Cherty Marker Bed	-	49.85	69.97
	E Marker Bed	-	8.96	19.05
	Lower Center Interburden	-	89.56	147.72
Lower Phosphate Zone	C	Low-Medium	7.44	16.22
	False Cap	-		
	B	Medium-High		
	Cap Rock	-		
	LPZ or A	High		
	Fish Scale Marker Bed	-		
	Footwall Mud	-	5.72	43.40

8.0 DEPOSIT TYPES

The following is a description of the mineral deposit type(s) being investigated and the geological model or concepts being applied in this TR.

The phosphate mineralization presented in this TR is sedimentary in nature, occurring in a conformable sequence of alternating phosphatic and weakly- to non-phosphatic shale, mudstone, carbonate, and chert beds within the Meade Peak Member of the Permian Phosphoria Formation. The Phosphoria Formation occurs within the Western Phosphate Field that occupies in excess of 135,000 square miles, spanning Eastern Idaho, Southern Montana, Western Wyoming, and northern half of Utah (Sheldon 1989).

The phosphate mineralization encountered in the Meade Peak Member is stratigraphic in nature and the deposit type is considered a typical example of a marine sedimentary phosphate deposit. The phosphate mineralization occurred during the primary depositional processes and there are no known secondary phases of phosphate mineralization or enrichment identified in the deposits.

The beds of the Meade Peak Member were deposited within a marine sedimentary basin within the Phosphoria Sea that marked the western margin of the North American craton approximately 250 Ma. During the period that the Meade Peak Member was being deposited, access to the open ocean was intermittently restricted by barrier islands during cyclical periods of eustatic sea level change resulting from periods of glaciation and deglaciation (Sheldon, 1984). This cyclical process resulted in the alternating beds of phosphatic shale and mudstone with layers of non-phosphatic shale, carbonate, and chert beds.

Low sea levels during periods of glaciation gave rise to periods of intense upwelling currents of cold nutrient rich waters entering the basin; these nutrient rich waters would become confined within the basin by the barrier island structures and would result in algal blooms. Restricted access to the open sea limited recharge or mixing of the waters in the basin while the lower sea level and restricted access limited the impacts of both marine carbonate deposition as well as terrestrial sedimentation during development of phosphatic beds.

The phosphate mineralization within the Meade Peak Member consists of apatite pellets, oolites, and sand grains, some of which are further cemented together into clusters of pellets and grains in an apatite cement; the apatite within the Meade Peak is entirely in the form of carbonate fluorapatite (Altschuler et. al. 1958).

Individual beds of the Meade Peak Member are laterally continuous over significant distances, with some beds commonly found distributed over tens of thousands of square miles within the Western Phosphate Field (Sheldon 1989); however, as discussed in Item 8, the thickness and geometry of the beds has been locally impacted on a deposit scale by both primary depositional variability as well as post-depositional structural modification due to both regional and deposit scale faulting and folding.

Exploration programs described in this TR have taken the stratigraphic nature of the mineralization into account and drill hole spacing, sampling methodology and grade analyses have been designed to evaluate the structural and grade continuity of the targeted phosphatic beds at the deposit scale.

9.0 EXPLORATION

This item discusses the nature and extent of all relevant historical and current exploration work, other than drilling, conducted by or on behalf of Itafos Conda for the 4 Itafos Conda projects and the PH Project that are the focus of this TR. Non-drilling exploration data evaluated as part of the current study on the 5 projects included:

- Itafos Conda grade control trench samples and analytical results from RVM and LCM.
- Surface exploration trench samples and analytical results from NDR.
- Surface exploration and adit samples from PH.
- Downhole wireline geophysical logs performed on the majority of the Conda drill holes.
- Surface seismic surveys at PH.
- Regional and deposit scale geological mapping.

The following discussion presents a summary of the methods and procedures for data collection, any potential biases that may impact the representivity and reliability of the data, and a discussion of any significant results and interpretations derived from the non-drilling exploration data.

9.1 RVM and LCM Grade Control Trench Samples

The geological database provided by Itafos Conda mining and geology personnel for RVM and LCM included 44 and 52 grade control samples respectively. These samples were collected by Conda mine geologists and grade control technicians as part of the ongoing mining operations.

The samples were collected from 100-foot spaced sections along the top of the benches in the mines. The section lines were oriented orthogonal to the strike of the beds such that the samples represented a section through the stratigraphic sequence. Given the sub-vertical dip of the stratigraphy in the current mining areas at RVM and LCM the samples can be considered a reliable representation of true thickness of the beds.

The Conda mining grade control team staked out the roof and floor contacts of the beds based on the visual identification of phosphatic and weakly- to non-phosphatic beds. A composite sample representing the full thickness of each identified bed was then collected manually using shovels and picks. The grade control sampling trenches were surveyed by the Conda mining survey team to allow for reliable 3D positioning of the data.

The samples were bagged in 2-gallon bags and delivered to the Conda onsite laboratory at the CPP, where they underwent sample preparation and analyses. Sample preparation comprised crushing to minus 1 inch and then riffle splitting. One split was dried for 0.5 hours to remove surface moisture and then was used to perform moisture content and P₂O₅ head grade analysis. The second split was placed in a wash bottle on a roller for 15 minutes followed by screening using a 325 mesh to replicate the washing process at the CPP wash plant. The screened sample was dried for 40 minutes and then recovery was calculated prior to the sample being pulverized for analyses.

A suite of 18 elements were run on the washed sample using the CPP Inductively coupled plasma - optical emission spectrometer (ICP-OES). The grade control sample rejects are then sent back to the mine where they are stored for three months before being recycled in the stockpiles or overburden stockpiles based on grade parameters of the samples.

The second split grade control samples are a good representation of the expected washed grades from the CPP Wash Plant; however, they are not representative of the in-situ grades approximated from the RC drill hole samples that form the bulk of the basis for the geological models (see Item 10.0 and Item 11.0 for further discussion on drilling and sampling, respectively).

The bed pick observations from the grade control samples were used by Golder to aid in modeling the bed roof and floor surfaces; however, given the differences in analytical bases, the grade data from these samples were not used in the grade modeling process. For the purpose of structural modeling, the trenches were converted to horizontal pseudo-drill holes using the surveyed coordinates from the start and end points of the sample section lines.

9.2 NDR Exploration Trench Samples

As part of the historical exploration work on the NDR property, 40 surface trench samples were collected during the 1989 and 1990 exploration campaigns. The trenches were laid out at approximately 1,000 foot spacing on a surveyed grid across the property as a means of collecting initial geological and grade information prior to commencing with the drilling programs on the project.

The trenches were mechanically stripped using a dozer and were then surveyed by the Conda mining surveyors. The surveyors recorded and flagged the bottom of the A bed and top of the C bed for the Lower Phosphate Zone and the bottom of the D52 bed and the top of the D1 bed for the Upper Phosphate Zone. The Conda mining grade control technicians then sampled the beds of each trench measuring thickness off these surveyed points.

The samples were bagged and sent to the CPP onsite laboratory for analysis in the same manner as the drill hole samples from the 1989 and 1990 exploration programs (see Item 10.0 for discussion). Both head grade and washed analyses were run for all samples. The tables of analytical results for the NDR trench samples as well as the surveyed coordinates are stored in a binder at CPP and have been converted to digital format.

A selection of the trench samples were used by Golder to supplement drilling data to aid in modeling the bed roof and floor surfaces; however, given the potential bases differences between the samples collected from the RC drill holes versus those collected from the NDR exploration trenches, the grade data from these samples were not used in the grade modeling process. For the purpose of structural modeling, the trenches were converted to horizontal pseudo-drill holes using the surveyed coordinates from the start and end points of the sample section lines.

9.3 PH Exploration Trench and Adit Samples

Surface trench sampling and sampling of exploration adits driven by ESI in the early- to mid-1970s are available for PH. However, the documentation on the sample collection, analytical, Quality Assurance/Quality Control (QA/QC), and other pertinent details surrounding these samples are limited or non-existent, leading to concerns surrounding their reliability and suitability for use in geological modeling and resource estimation.

Based on the inability to reliably verify the methods and results from the ESI trench and adit sampling programs, the Golder QP elected to exclude the ESI trench and adit sampling results from the PH modeling database and this information was not used for the purpose of estimating Mineral Resources.

9.4 Wireline Geophysical Logs

Natural gamma (gamma) wireline geophysical logs were performed on the majority of the Itafos Conda projects and PH Project drill holes as part of the standard drilling procedures for Conda and its predecessors. As is common in many sedimentary phosphate deposits, the phosphate bearing beds are readily distinguishable from the weakly phosphatic and non-phosphatic beds/units using the wireline gamma logs. Elevated counts in the gamma logs for phosphate deposits are most commonly attributed to radioactive decay of uranium that has substituted for other elements in the apatite mineral structure (USGS 1968).

As a result of the generally low lateral variability in bed thicknesses and grade variability, the beds are also commonly represented by easily distinguishable gamma signatures that allow for ease of correlation of beds between drill holes. There are instances where correlation of some of the beds from Itafos Conda projects was difficult via the gamma logs. In these instances, local bed thickness variability, either depositional or structurally induced, as well as less than ideal intercept angles between drill holes and the beds has resulted in structural repeats, masking or skewing of the gamma signatures for the beds, making bed name assignment and correlation more complex.

A summary of gamma log data availability by drill hole and project is presented in Table 9-1.

Table 9-1: Summary of Drill Holes with Available Wireline Gamma Logs by Project

Project	Total Drill Holes	Holes with Available Geophysical Wireline Logs
RVM	210	210
LCM	48	46
NDR	253	253
H1	235	235
SMCM*	66	0
PH**	65	48

Note:

Wireline log data was not available for the 66 drill holes from the SMCM area included in the H1 model.

Wireline log data was not available for the 11 ESI drill holes included in the PH model. Nor was it available for 6 of the 9 PHA drill holes that were used for structure modeling only.

The gamma logs were used along with the assay results by the Conda geologists, under the supervision of their Senior Geologist, during the exploration programs to identify sample intervals for grade analysis, to correct the bed pick depths and to assign the bed names to the individual beds intercepted in the drill holes.

The use of assay results and wireline gamma logs to correct bed depth picks improves the confidence in the depth intervals as the wireline depths are more precise than the drill run counts and are a reliable tool in mitigating against mixing or cuttings loss in RC drilling and core loss in core drilling. The assay results and the gamma logs also serve as a semi-quantitative means for assigning bed names rather than a pure qualitative assignment based on the geologist's visual interpretation based on RC cuttings or drill core visual logging observations.

Golder's QP reviewed the methodologies utilized by the Conda geological team to adjust the drill depths and correlate phosphatic units during the April and September 2019 site visits. The Golder QP agreed with the wireline gamma logging and interpretive procedures applied by Conda and is of the opinion that they were being performed to appropriate industry standard practices.

9.5 PH Project Seismic Surveys

A 2011 report by RPS Boyd PetroSearch (RPS Boyd, 2011) indicates that five seismic lines that transect portions of the PH Project were reprocessed and used in a general 2-dimensional (2D) seismic interpretation of the stratigraphy and structure of the deposit. Documentation in the RPS Boyd, 2011 report indicates the seismic lines were a combination of Vibroseise seismic surveys (truck mounted seismic vibration method) and conventional Poulter method surveys (air-blast dynamite method).

The various historical reports on the PH Project indicate that the seismic profiles confirmed the general geometry of the stratigraphy observed in drilling and were particularly useful in identifying the series of high angle normal faults that transect the deposit. The seismic profiles provide an ideal perspective of the faults encountered on the property as their near sub-vertical nature makes them difficult to characterize the fault geometry and displacement from vertical or slightly inclined surface drill holes.

Golder did not review the seismic profiles or raw data for the seismic surveys but has reviewed the generalized structural interpretations derived from the seismic surveys presented in the RPS Boyd, 2011, report. The Golder QP is of the opinion that the data and interpretation presented in the RPS Boyd, 2011, report support a reasonable stratigraphic and structural interpretive framework for the geometry and distribution of the PH Project and this general framework, including general trend of the stratigraphy and placement and dips of the faults, have been incorporated into Golder's geological model for the PH Project.

9.6 Regional and Deposit Scale Geological Mapping

As part of the evaluation of stratigraphic and structural geometries and controls on the deposits, Golder consulted a series of regional and deposit scale surficial geological maps and sections.

The regional maps were from the USGS quadrangle map series (1:24,000 scale) and were used to identify the surface traces of significant faults that transected the Itafos Conda projects. The maps were also consulted for general location of contacts between geological units in the deposits; however, as the maps were not developed with the level of detail available in the Conda drilling programs, these were used for general reference only and were not used as a formal source of survey data in the geological models.

In a similar manner, regional and deposit scale mapping from previous studies at the PH Project were used to aid in identifying the surface traces of the regional and deposit scale faults in the area, as well as for locating the area impacted by the overturned limb.

Golder has accepted the general stratigraphic and structural interpretations derived from the regional mapping for the Itafos Conda projects, the PH Project and the areas surrounding these deposits and has incorporated the general stratigraphic and structural elements of the regional and deposit scale mapping into the Golder geological models for each of the five projects.

10.0 DRILLING

10.1 Drilling Methods

Itafos Conda Projects Drilling

The Itafos Conda projects have primarily been drilled using RC drilling methods, supplemented in special cases by a small number of core holes drilled for geotechnical, metallurgical, and other purposes. Drilling has been performed by several different independent drilling contractors over the various campaigns on the four projects.

Drill hole collar location maps for the four Itafos Conda projects are presented in Figure 10-1 through Figure 10-3 while representative sections for each of the four Itafos Conda projects are presented in Figure 10-4 through Figure 10-7. A summary table of drilling by project is presented in Table 10-1.

The RC holes were drilled using both wheeled and track mounted RC drill rigs. Except for a small number of drill holes where a hammer bit was used, most of the RC holes were drilled using a 4.25 to 5.25-inch tri-cone bit. RC chips were recovered from the cyclone on the drill rig and were visually logged for lithology type. Typically, cuttings were recovered for every 2-foot downhole interval although in some cases, 6-foot intervals were used. A small representative sample of the chips was stored in chip trays for each 2-foot downhole interval. A sample split was taken from the RC cuttings for sample preparation in advance of submitting to the laboratory for grade analysis (see Item 11.0 for a discussion of sample preparation and assay procedures).

Core holes at the Itafos Conda projects are either drilled to HQ or PQ size (outer hole diameters of 4.5 inches and 5.5 inches, core diameters of 2.5 inches and 3.4 inches, respectively). Prior to the recently completed 2019 metallurgical drilling program on H1, the results of which were not available for this current study, core drilling on the Itafos Conda projects was limited to geotechnical drilling on the projects between 2010 and 2013.

The core holes were visually logged and gamma wireline surveys were performed. The downhole lithology data has been incorporated into the modeling database; however, as the focus was on collecting geotechnical samples, these core holes were not systematically sampled for grade analysis. Sampling for assay appears sporadic through the core holes and as a result the grade data for these holes is deemed not to be representative of the full intercepts and as such was not included in the assay database.

Although no formal documentation of Conda RC and core drilling procedures are available, Golder reviewed the RC drilling and coring procedures with Conda and exploration contractor senior personnel during the QP site visits in April 2019 and September 2019 and is in general agreement that the drilling procedures are completed to industry standards based on the procedures discussed. It is the Golder QP's opinion that the data and retained RC chips and core are consistent with collection via the described methods.

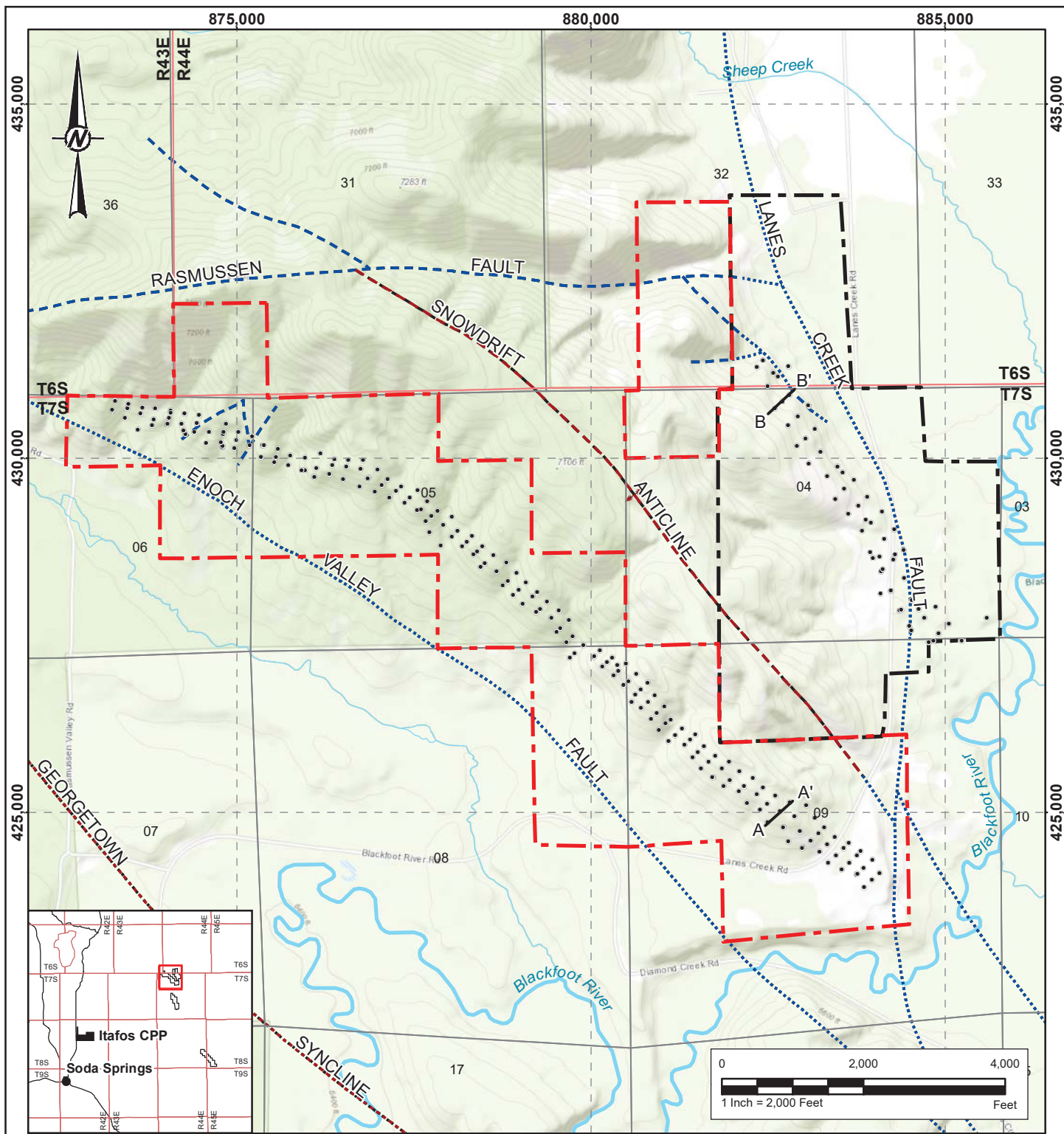

LEGEND

- RVM Lease Boundary
- LCM Lease Boundary
- Township and Range
- Section
- Drill Hole
- Cross-Section (A - A')
- Anticline - Inferred
- Syncline - Concealed
- Contact - Inferred
- Contact - Concealed
- Thrust fault - Concealed
- River/Stream

CLIENT
ITAFOS CONDA LLC

PROJECT
NI 43-101 TECHNICAL REPORT FOR CONDA PHOSPHATE OPERATIONS

TITLE
RASMUSSEN VALLEY MINE AND LANES CREEK MINE DRILL HOLE LOCATION MAP

CONSULTANT	YYYY-MM-DD	2019-12-10
DESIGNED	-	
PREPARED	EFT	
REVIEWED	DW	
APPROVED	JD	



REFERENCE(S)
1. COORDINATE SYSTEM: NAD 1983 STATE PLANE IDAHO EAST FIPS 1101 FEET
2. DATA PROVIDED BY ITAFOS CONDA LLC

PROJECT NO. 18114499 CONTROL 0001 REV. - FIGURE 10-1

1 in IF THIS MEASUREMENT DOES NOT MATCH WHAT IS SHOWN, THE SHEET SIZE HAS BEEN MODIFIED FROM: ANSI/A

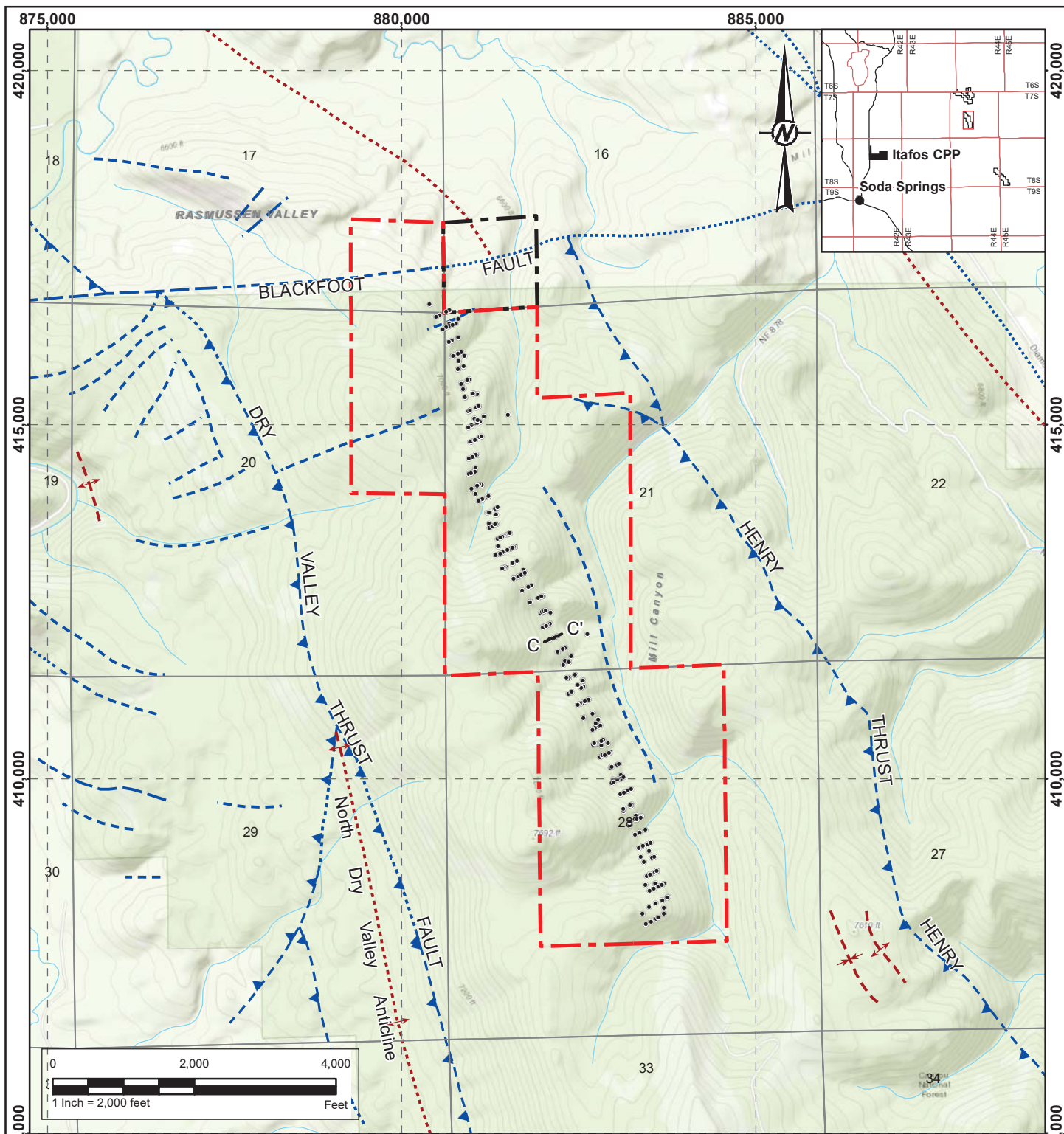

- LEGEND**
- - - North Dry Ridge Lease Boundary
 - - - North Dry Ridge State Lease
 - 1 Section
 - Drill Hole
 - Cross-Section (C - C')
 - - - Anticline - Inferred
 - - - Anticline - Concealed
 - - - Syncline - Inferred
 - - - Syncline - Concealed
 - - - Contact - Approximate
 - - - Contact - Inferred
 - - - Contact - Concealed
 - - - Thrust fault - Inferred
 - - - Thrust fault - Concealed
 - ~ ~ ~ River/Stream

CLIENT
ITAFOS CONDA LLC

PROJECT
NI 43-101 TECHNICAL REPORT FOR CONDA PHOSPHATE OPERATIONS

TITLE
NORTH DRY RIDGE DRILL HOLE LOCATION MAP

CONSULTANT	YYYY-MM-DD	2019-12-10
DESIGNED	-	
PREPARED	EFT	
REVIEWED	DW	
APPROVED	JD	



REFERENCE(S)
 1. COORDINATE SYSTEM: NAD 1983 STATE PLANE IDAHO EAST FIPS 1101 FEET
 2. DATA PROVIDED BY ITAFOS CONDA LLC

PROJECT NO. 18114499 CONTROL 0001 REV. - FIGURE 10-2

IF THIS MEASUREMENT DOES NOT MATCH WHAT IS SHOWN, THE SHEET SIZE HAS BEEN MODIFIED FROM: ANSI/A

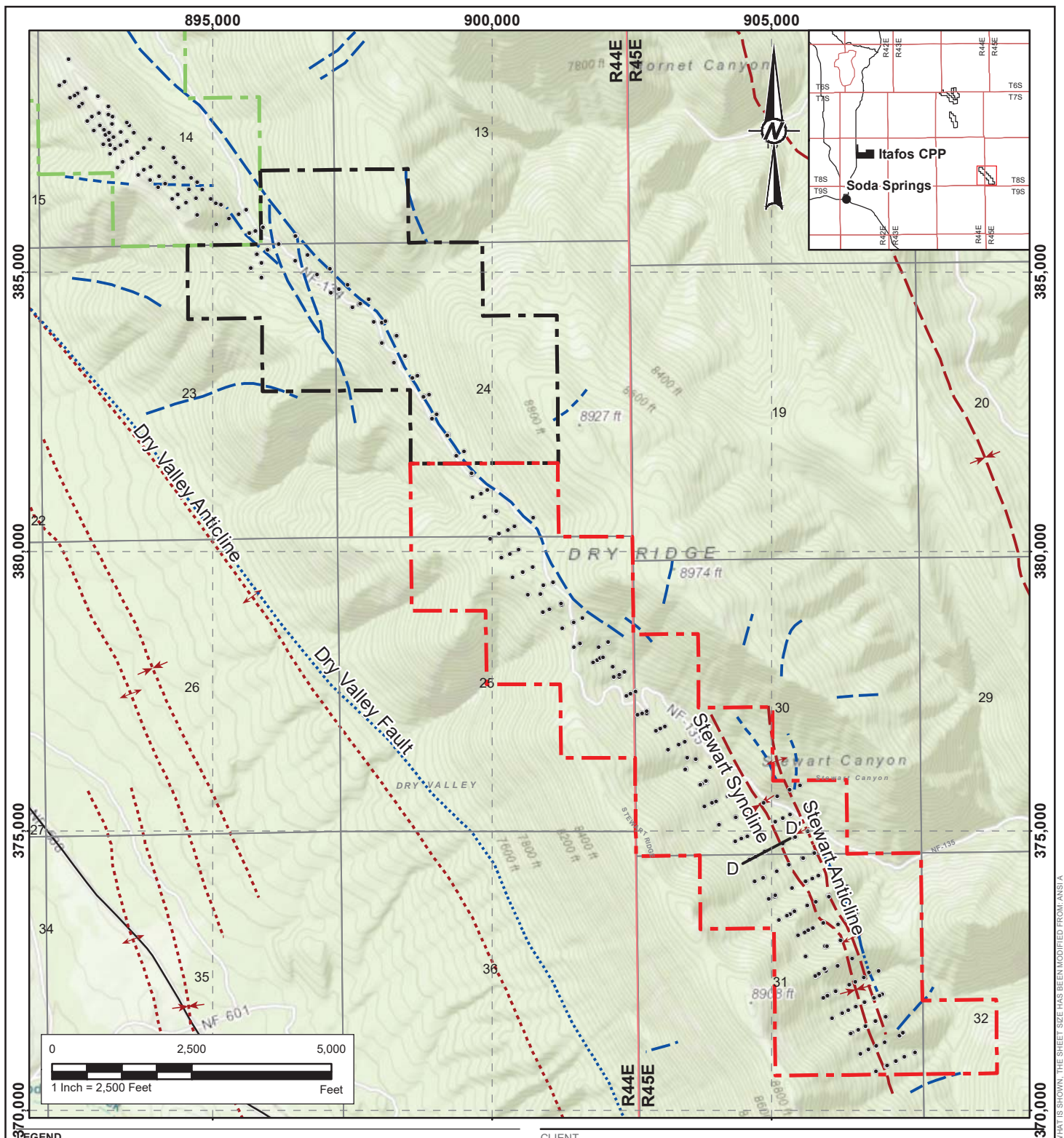

LEGEND

- | | |
|--|-------------------------|
| H1 Lease Boundary | Anticline - Approximate |
| H1 KPLA | Anticline - Concealed |
| South Maybe Canyon Mine Lease Boundary | Syncline - Approximate |
| Township and Range | Syncline - Concealed |
| Section | Contact - Approximate |
| Drill Hole | Contact - Inferred |
| Cross-Section (D - D') | Contact - Concealed |

REFERENCE(S)

- COORDINATE SYSTEM: NAD 1983 STATE PLANE IDAHO EAST FIPS 1101 FEET
- DATA PROVIDED BY ITAFOS CONDA LLC

CLIENT
ITAFOS CONDA LLC

PROJECT
NI 43-101 TECHNICAL REPORT FOR CONDA PHOSPHATE OPERATIONS

TITLE
HUSKY 1 DRILL HOLE LOCATION MAP

CONSULTANT



YYYY-MM-DD	2019-12-10
DESIGNED	-
PREPARED	EFT
REVIEWED	DW
APPROVED	JD

PROJECT NO.	CONTROL	REV.	FIGURE
18114499	0001	-	10-3

IF THIS MEASUREMENT DOES NOT MATCH WHAT IS SHOWN, THE SHEET SIZE HAS BEEN MODIFIED FROM: ANS I/A

Figure 10-4: Rasmussen Valley Mine Representative Cross Section

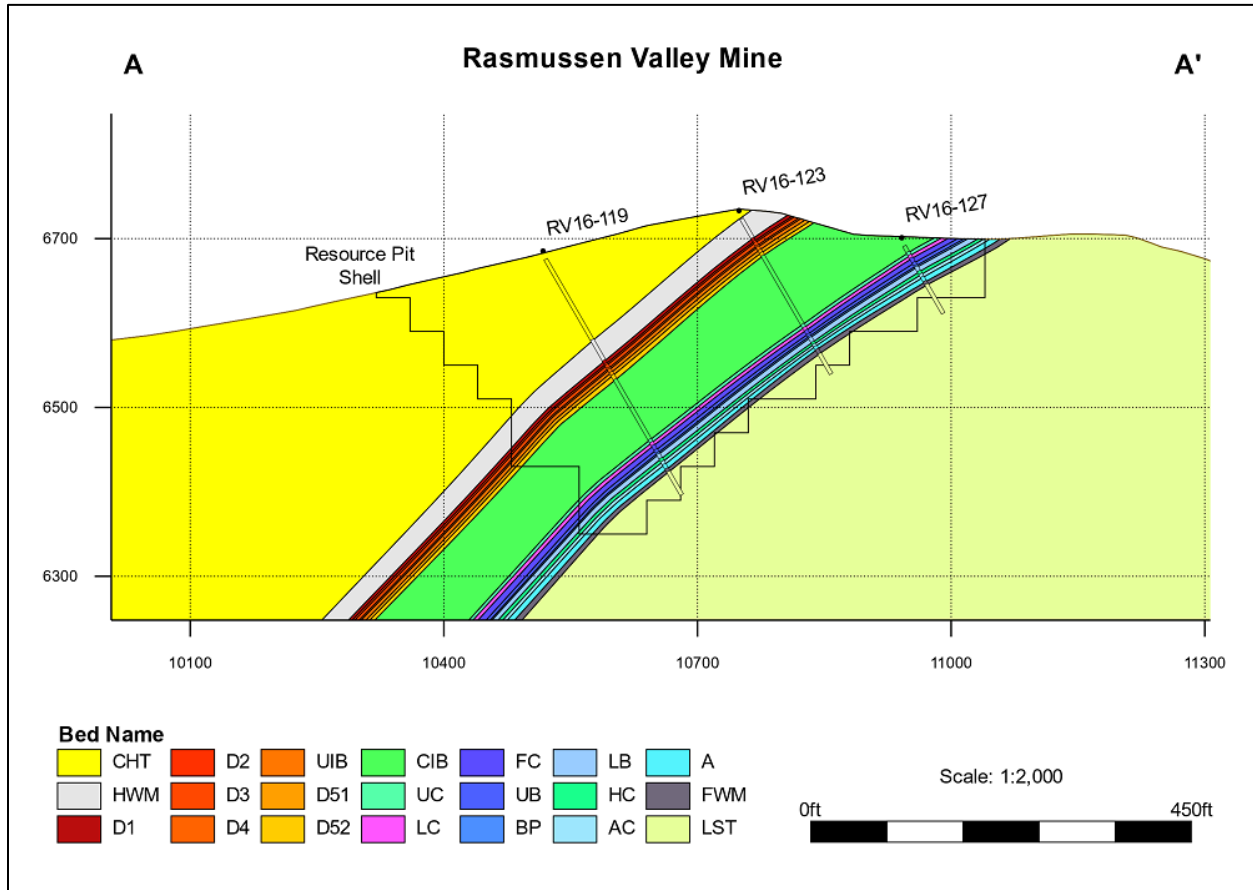

Note: (A-A') as shown on Figure 10.1.

Figure 10-5: Lanes Creek Mine Representative Cross Section

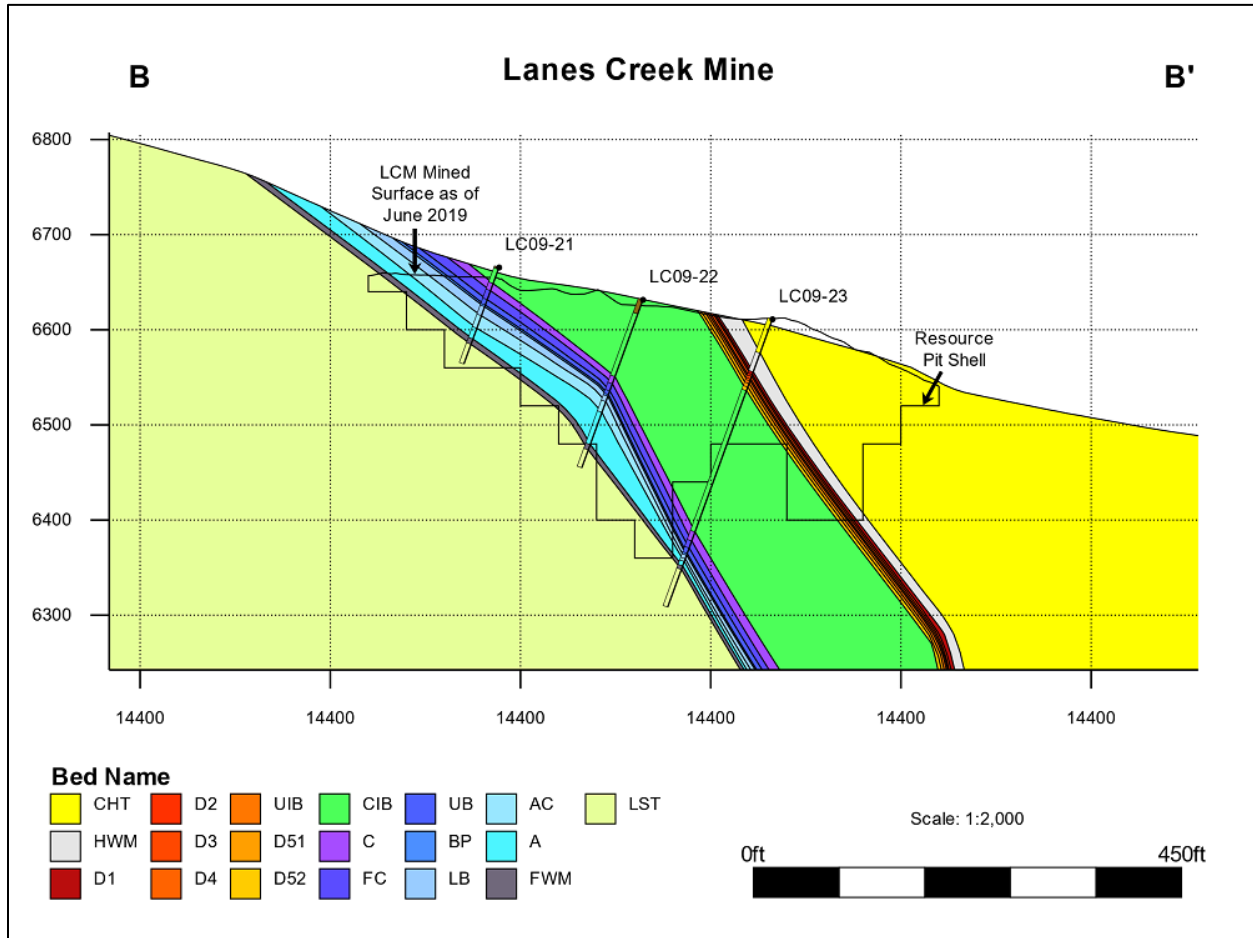

Note: (B-B') as shown on Figure 10.1.

Figure 10-6: North Dry Ridge Project Representative Cross Section

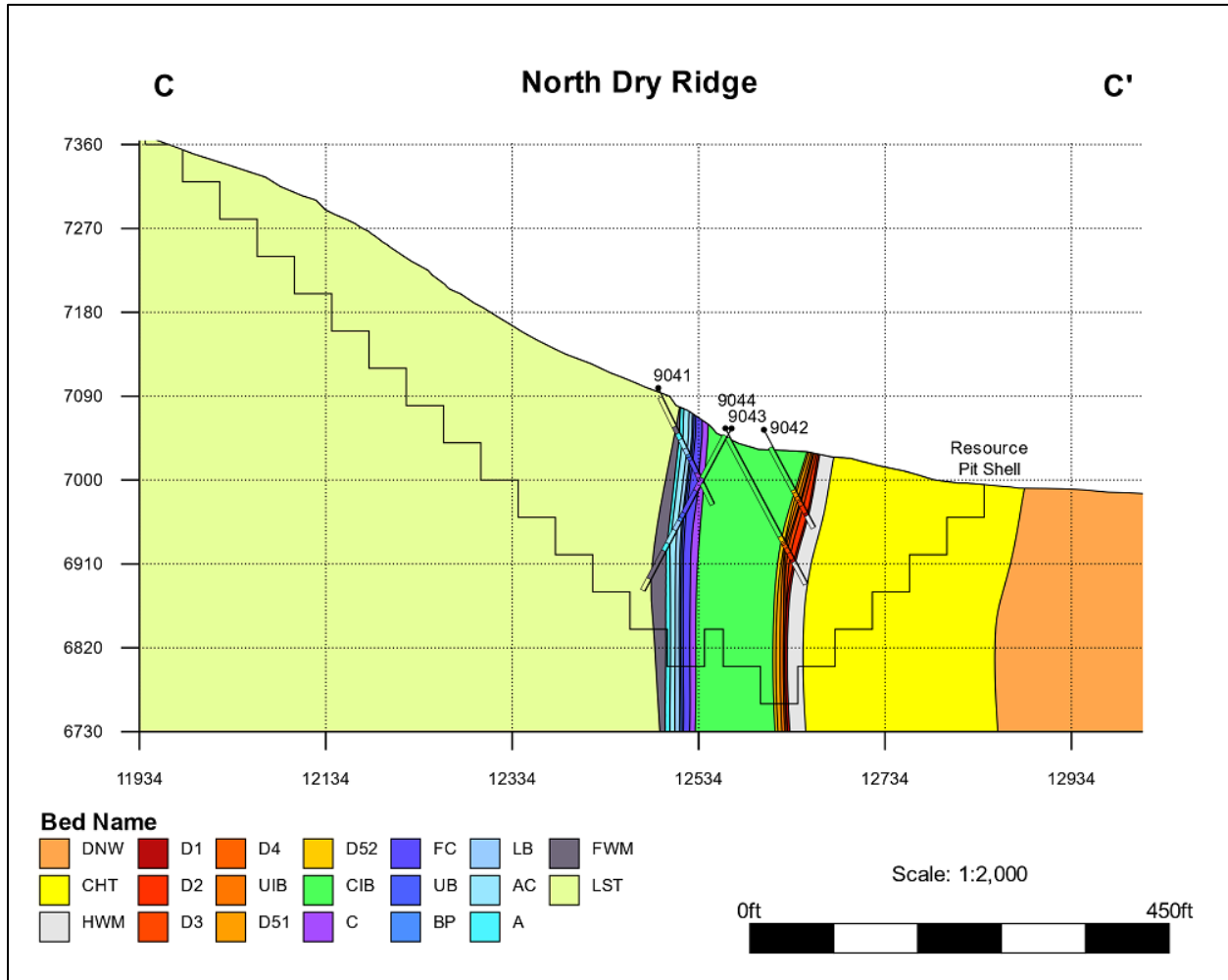

Note: (C-C') as shown on Figure 10.2.

Figure 10-7: Husky 1 Project Representative Cross Section

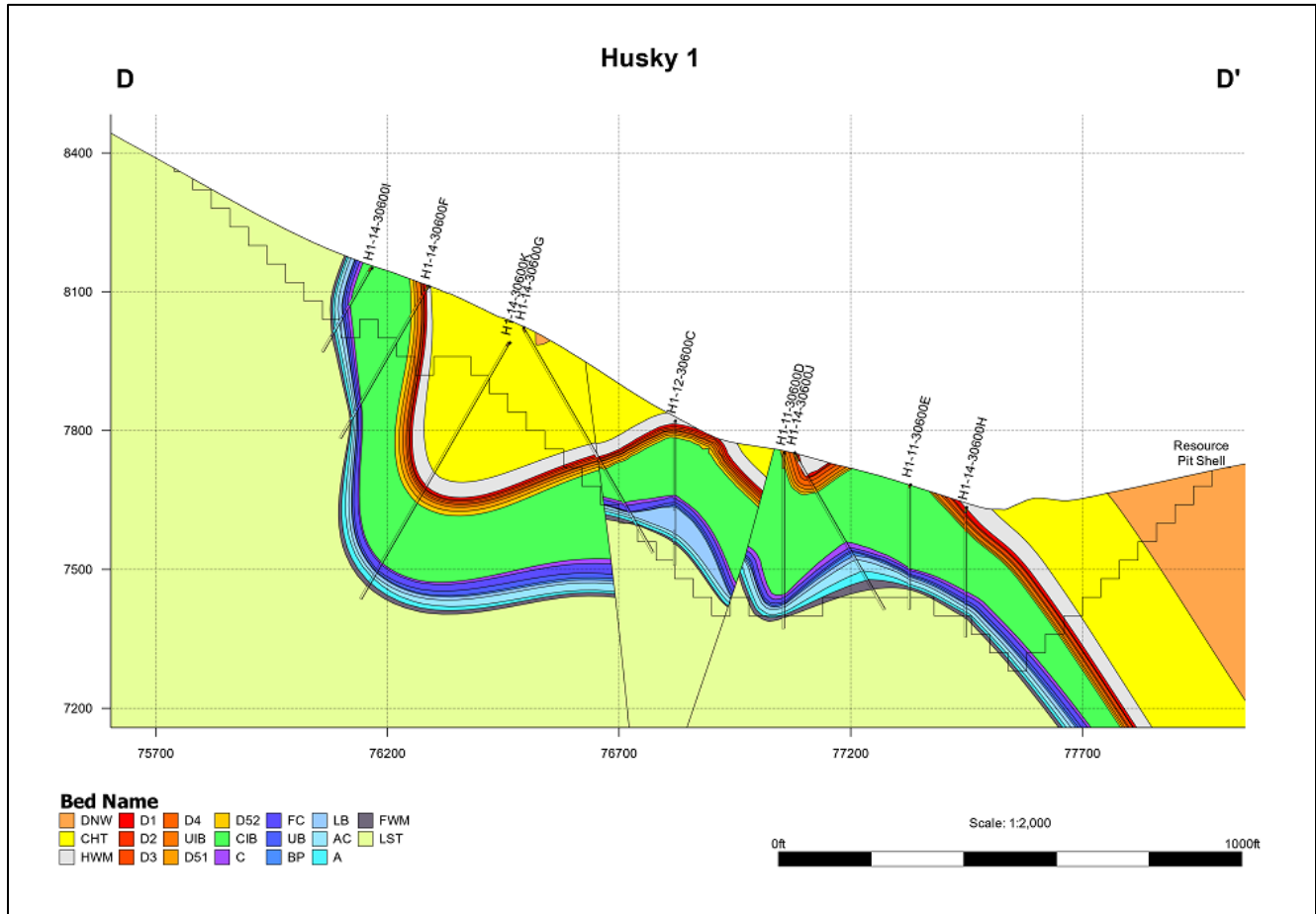

Note: (D-D') as shown on Figure 10.3.

Table 10-1: Drilling Data Summary by Itafos Conda Project

Project	Total Drill Holes	Drill Holes With Available Data				
		Collar Surveys	Downhole Surveys	Downhole Lithology Records	Raw Assay Data	Geophysical Wireline Logs
RVM	210	210	0	210	198	210
LCM	48	48	2	48	48	46
NDR	253	253	0	253	212	253
H1	235	235	0	235	192	235
SMCM*	66	66	0	66	66	0

Note:

Wireline log data was not available for the 66 drill holes from the SMCM area included in the H1 model.

Although details may vary by projects and by drilling campaign, general procedures for drilling on the Itafos Conda projects include the following:

- Site preparation.
- RC or core drilling by an independent drilling contractor.
- Tracking core depths and intervals.
- Determining core recovery (core holes only).
- Measuring the Rock Quality Determination (RQD; core holes only).
- Drill site RC chips or core photographs.
- Describing the RC chips or core, logging chips, or core.
- Transferring the chips to chip trays, or core to the core box.
- Labelling chip trays or core boxes and sleeves.
- Transporting chip trays or core boxes from the drill site to the core warehouse.
- Preparing the daily field report.
- Calling the hole for completion.
- Hole abandonment or piezometer installation in isolated instances where exploration drill holes have been converted for use as water level monitoring wells.

Additional drilling related tasks included:

- Collecting gamma ray geophysical logs.
- Surveying drill hole collars (no downhole positional surveys were performed on Conda drill holes).
- Downhole positional surveying commencing in 2019.
- Sampling RC chips or drill core.
- Archiving RC chips or core in the Wooley Valley Shop.

PH Project Drilling

The PH Project area has been drilled with the use of RC and core drilling. Drilling was contracted to Major Drilling Group International, Inc (Major), and drilling commenced on September 23, 2010.

A summary table of drilling for the PH Project is presented in Table 10-2. A drill hole collar location map for the PH Project is presented in Figure 10-8. while a representative section for the PH Project is presented in Figure 10-9.

Table 10-2: Drilling Data Summary for the Paris Hills Project

Project	Total Drill Holes	Drill Holes With Available Data				
		Collar Surveys	Downhole Surveys	Downhole Lithology Records	Raw Assay Data	Geophysical Wireline Logs
PH	65	65	40	65	45	48

Note:
Wireline log data was not available for the 11 ESI drill holes included in the PH model nor for 6 of the 9 PHA drill holes that were used for structure modeling only.

The Golder grade model was developed using the same 45 PHA drill holes that were used in the Agapito 2013 model and estimate (Agapito, 2013); however, Golder also used an additional 9 drill holes from the PHA exploration campaigns and 11 drill holes from the ESI exploration campaigns for structural and stratigraphic modeling. Grade data was not interpolated from these additional 20 drill holes.

Early drilling yielded poor core recovery and incomplete datasets. Given the concerns regarding reliability, these earlier drill holes were excluded from the modeling database. The poor drilling was rectified with the introduction of a strict QA/QC protocol that included the following guidelines:

- Drill holes that did not meet targeted core recovery were re-drilled.
- All previous holes were re-logged, re-measured and depth-corrected to gamma geophysical logs.

Core holes are either drilled to HQ, or PQ, size, although PQ results in a higher core recovery. Size details are described below:

- HQ – Utilizes HWT Casing (4.5-inch outer diameter, 4.0-inch inner diameter), resulting in 2.5-inch core diameter.
- PQ – Utilizes PWT Casing (5.5-inch outer diameter, 5.0-inch inner diameter), resulting in 3.4-inch core diameter.

The larger PQ holes are preferred when drilling the hole for quality assay results. The smaller HQ holes are utilized for specialty testing such as hydrogeology and methane.

HQ core drilling was used in the shallower holes in the southern portion of the project. As drilling advanced northwards, core recovery issues in the deeper holes resulted in a switch to PQ core drilling.

Coring completed after March 5, 2011, was achieved by triple tube (split-inner core tube) methods and a geologist was on site during drilling activities. Triple tube core is preferred, so that RQD can be assessed on the drill core.

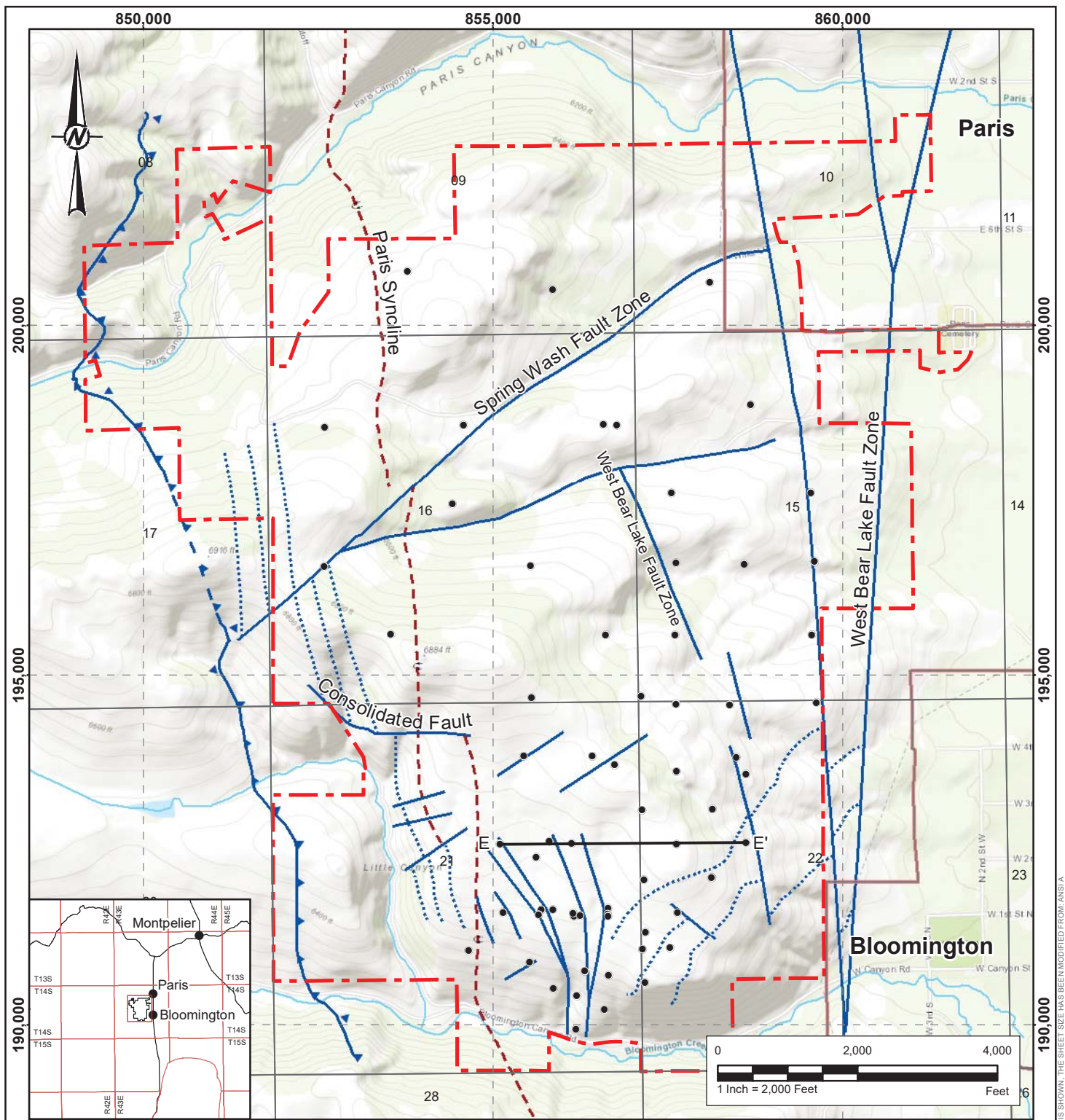

LEGEND

- ▬ Paris Hills Mine Boundary
- City/Town
- Section
- Drill Hole
- Cross-Section (E - E')
- ⋯ Contact - Concealed
- Surface Fault Expression
- ▲ Thrust Fault - Approximate
- ▲ Thrust - Concealed
- ⋯ Axis of Overturned Syncline
- ~ River/Stream

CLIENT
ITAFOS CONDA LLC

PROJECT
NI 43-101 TECHNICAL REPORT FOR CONDA PHOSPHATE OPERATIONS

TITLE
PARIS HILLS DRILL HOLE LOCATION MAP

CONSULTANT
YYYY-MM-DD 2019-12-13



DESIGNED -
PREPARED EFT
REVIEWED DW
APPROVED JD

REFERENCE(S)
1. COORDINATE SYSTEM: NAD 1983 STATE PLANE IDAHO EAST FIPS 1101 FEET
2. DATA PROVIDED BY ITAFOS CONDA LLC

PROJECT NO. 18114499 CONTROL 0001 REV. - FIGURE 10-8

IF THIS MEASUREMENT DOES NOT MATCH WHAT IS SHOWN, THE SHEET SIZE HAS BEEN MODIFIED FROM: ANSI A

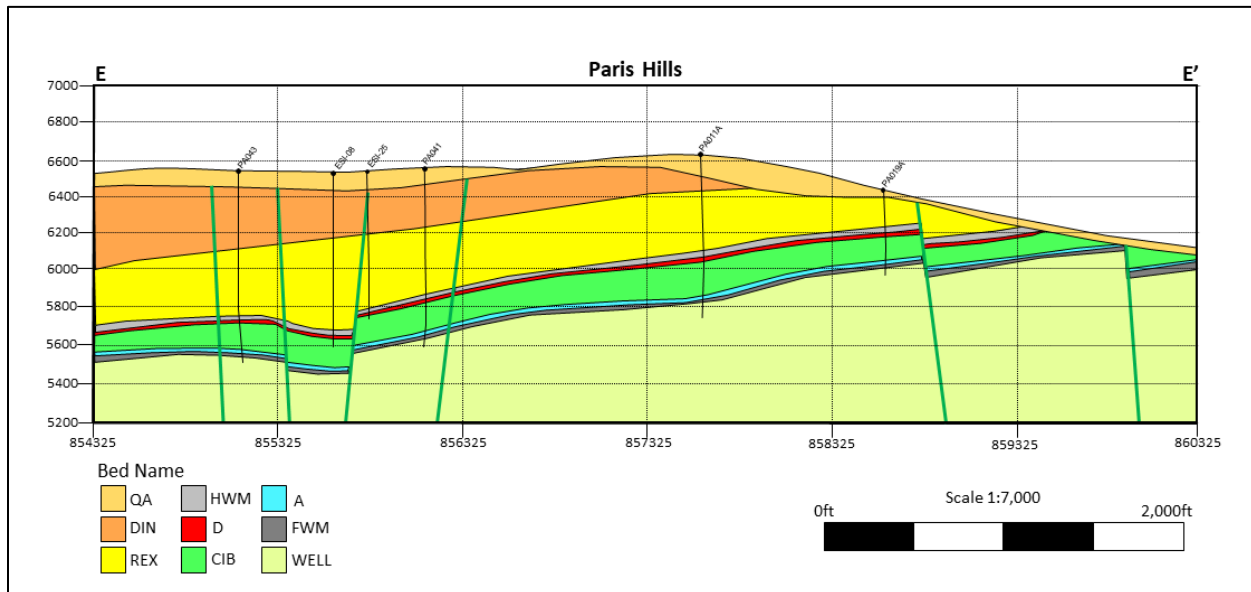
Figure 10-9: Paris Hills Project Representative Cross Section

Note: (E-E') as shown on Figure 10.8.

Golder reviewed the drilling and coring procedures outlined in the Paris Hills Agricom Inc. Exploration Drilling Procedures, updated dated January 26, 2016, and is in general agreement that the drilling procedures are completed to industry standards based on the procedures outlined in the document.

Drilling procedures for spilt-tube coring include:

- Site preparation
- Core drilling by an independent drilling contractor
- Tracking core depths and intervals
- Determining core recovery
- Measuring the RQD
- Drill site core photographs
- Describing the core, logging core
- Transferring the core to the core box
- Labelling core boxes and sleeves
- Transporting core boxes from the drill site to the core warehouse
- Preparing the daily field report
- Calling the hole for completion
- Hole abandonment

- Piezometer installation

Additional procedures for drilling included:

- Collecting gamma ray geophysical logs
- Surveying drill hole collars and performing downhole positional surveys
- Sampling core
- Archiving core in the PH core shed

10.2 Impacts of Drilling on the Accuracy and Reliability of the Results

This Item discusses drilling, sampling, and recovery factors that could materially impact the accuracy and reliability of the results for the Itafos Conda projects and the PH Project.

Itafos Conda Projects

There are several potential drilling related impacts on the accuracy and reliability of the Itafos Conda projects data, relating to the following:

- Local reliance on older or third-party drilling.
- Absence of downhole positional surveys.
- Factors relating to sample recovery from RC drilling.

Portions of the NDR and H1 projects rely on older drilling and or drilling performed on behalf of third parties, where the documentation of methods and results is not as robust as during more recent drilling programs. Areas impacted by this include the use of 231 drill holes from the 1989 and 1990 drilling campaigns on NDR and 66 drill holes from the SMC area that were drilled by Monsanto (now Bayer) in 1976 through 1989 and provided to Conda. Golder recommends verification drilling in these areas to improve confidence in these older and third-party drill holes.

The complete absence of downhole deviation surveys for drill holes from the Itafos Conda projects leads to uncertainty in the actual positioning of samples in 3-dimensional (3D) space. All drill holes are currently modeled as either vertical (-90-degree (°) plunge along the length of the drill hole) or at a fixed inclination based on measured collar dip (again, applied to the entire length of the drill hole). Initial review of downhole deviation data from the 2019 metallurgical drilling program suggests minimal downhole deviation; however; this should be reviewed further to fully evaluate the potential impact.

Given the steep to subvertical dips of the beds through most of the Itafos Conda projects, small deviations in the xy positioning of the drill hole intervals and associated samples can have significant impacts on the geometry and distribution of the units in the model. During the modeling process, Golder identified some localized structural anomalies that are interpreted to be a result of interval/sample positioning in the un-deviated drill holes; however, to avoid adding interpretive bias, Golder has honored the un-deviated data and has not made any adjustments to the interval and sample positioning. It is recommended that future drilling on the deposits include surveying for downhole deviation in order to allow for a quantitative assessment of the impacts on downhole deviation on the modeling.

The models for the Itafos Conda projects are also impacted by the intercept angles between the drill holes and the bed roof and floor contacts. The stratigraphy is steeply dipping to sub-vertical across much of the strike length of the Itafos Conda projects; however, due to topography and drill planning decisions, a significant portion of the drilling, especially during earlier drilling campaigns, was conducted from the top of the ridge and drilled as vertical or subvertical drill holes. Later drilling programs included inclined drilling at angles of between 88 to 42 degrees from horizontal.

The vertical to sub-vertical nature of both drilling and stratigraphy result in a lot of the intercepts being an apparent thickness rather than approximating true thickness, with some of the drill holes appearing to drill down dip (at very low angles to the bed roof and floor contacts) resulting in very long downhole intercepts for some beds. Although the inclusion of inclined holes has improved intercept angles in general, many of the inclined drill holes still result in apparent thickness intercepts due to the dip of the stratigraphy.

This relationship between drilling and bedding intercept angles can further compound the issues relating to lack of downhole deviation surveys discussed above. As the drill hole advances, the drill string will often follow the path of least resistance and in the Qualified Persons professional experience, can often be observed deflecting or deviating towards the down-dip direction when downhole deviation data is available for drilling that intercepts bedding at low intercept angles. Golder believes that the lack of downhole surveying does reduce the confidence in the data; however, further study is necessary to fully understand the significance and impact.

Downhole deviation data from any future drilling programs on Itafos Conda projects should be evaluated to further understand the impacts of the relationships between drilling and bedding contact intercept angles. Depending on the outcomes, it may be necessary to consider means for improving the drilling intercept angles, including longer standoff distances to allow for shallower drill hole plunges (at the expense of much longer drill holes), or mechanical means such as directional drilling or wedging to improve the intercept angles.

Uncertainty also exists for the Itafos Conda drill holes between the potential effects of RC drilling on the grade analyses. Various Itafos Conda personnel speculate that the loss of non-phosphatic fines during the RC drilling process has resulted in a slightly improved or partially washed sample compared to the actual in-situ grade values. Golder performed a high-level review by evaluating the P_2O_5 head grade and washed sample grade values from trench samples taken from the RVM and LCM pits against nearby RC drill holes. However, the results were inconclusive in part due to the fact that there were no trench and RC hole pairs that were very close (within several feet) to be able to rule out inherent variability as the cause of any differences between trench head grade, trench washed and RC sample grades. Golder recommends that the grade and recovery results from twinned RC and core drill holes on the 2019 metallurgical drilling program be compared once the results become available to determine if there is indeed a partial washing effect resulting in higher or lower grades relative to in-situ parameters.

PH Project

PH Project drilling is generally of higher confidence level relative to the Itafos Conda drilling as the bulk of the less reliable historical drilling has been replaced by core drill holes drilled, logged, sampled and surveyed in accordance with industry standard practices. The small number of historical drill holes used for structural modeling (were not used for grade modeling) are distributed throughout the deposit and so there is not a spatial bias associated with the inclusion of the older drill holes.

The stratigraphy across most of the PH Project dips moderately at approximately 17 degrees towards the north-northeast. This moderate dip allows for much better intercept angles between vertical or slightly inclined drill holes from surface.

The presence of downhole positional surveys for the PH drilling provides added confidence in the downhole interval and sample positioning and intercept angles between the drill hole and the beds.

There were a number of instances during the 2010-2012 drilling programs where the UPZ was not cored during drilling (cut using RC methods prior to switching to coring methods) as well as several drill holes that were lost before coring the complete LPZ; however, these occurrences were generally isolated and in most instances were replaced by a second drill hole located nearby that cored the full thickness of both the UPZ and the LPZ.

10.3 Relationship Between Drill Intercept Angles and Bed Contacts

As discussed in the previous Item, the combination of vertical and steeply inclined drill holes targeting subvertical to steeply dipping stratigraphy has resulted in apparent thickness intercepts for most of the Itafos Conda drill holes across the four projects. Uncertainty of drilling and bedding intercept angles is further compounded by the absence of downhole deviation surveys for the Itafos Conda drill holes. A review of downhole deviation should be performed using the results of the 2019 metallurgical drilling program to assess the potential impact drill hole deviation may play in spatial positioning of drill intercepts as well as the intercept angles between the drill holes and bed contacts.

The moderate dip of stratigraphy at the PH Project allows for much improved drill hole and bedding intercept angles compared to those at the Itafos Conda projects. Confidence in the intercept angles at PH is improved by the fact that all drill holes had downhole deviation surveys performed on them following the completion of the drilling. While not achieving true right-angle intercepts in all instances, the PH drill holes are generally a reasonable representation of true thickness.

11.0 SAMPLE PREPARATION, ANALYSES, AND SECURITY

11.1 Itafos Conda Projects Sample Preparation

Although no formal documentation of Itafos Conda projects sampling, analyses, and sample security (chain of custody) procedures are available, Golder reviewed the sampling and analyses procedures with Conda and exploration contractor senior personnel during the QP site visits in April 2019 and September 2019 and is in general agreement that the sampling and analytical procedures are completed to industry standards based on the procedures discussed and observed. It is the Golder QP's opinion that the analytical results provided for the four Itafos Conda projects are consistent with sampling and analyses via the described methods.

As core drilling at the Itafos Conda projects was generally limited to a small number of holes for purposes other than exploration and resource delineation, the discussion of sampling, analyses, and chain of custody for the Itafos Conda projects focuses on the RC drill hole samples.

Although details may vary by projects and by drilling campaign, general procedures for sampling from RC drill holes on the Itafos Conda projects included the following:

- Upon completion of the drill hole the wireline gamma logs were run and processed. The logs were then plotted, and bed picks and bed correlations were performed by the exploration contractor senior geologists. The bed picks and correlations were then reviewed and finalized by the senior Conda geologist.
- The gamma log picks were then used to prepare the sampling list, which identified the sample intervals for the individual beds from the UPZ and LPZ for each drill hole.
- RC sample lengths varied between projects and across drilling campaigns but were typically 2 feet for RVM, LCM, and H1 and 5 feet for NDR.
- Given the nature of sample recovery from RC drilling, the samples could not be split out by bed contacts.
- To confirm that the target beds were captured in the sampling as well as to provide grade data for dilution material for future mining studies, the following sampling rules were applied:
 - Sampling for the UPZ must begin at least 10 feet above and continue at least 10 feet below the UPZ.
 - Sampling for the LPZ must begin at least 10 feet above and continue at least 10 feet below the LPZ.
- The RC cuttings sample bags were then selected and transferred to the sample preparation area.

Sample preparation procedures for the samples from RC drill holes for the Itafos Conda projects included the following:

- Sample bags were opened, and RC cuttings were placed on a drying tray, one sample per tray, and placed on shelves under heat lamps in the drying sheds. Samples were dried between 500- and 550-degrees Fahrenheit for 24 hours.
- The dried sample was then run through a jaw crusher.

- The crushed sample was then split using a riffle splitter. One split was used to prepare the analytical pulp while the other split was retained for reference.
- The analytical split from the riffle splitter was then pulverized. The resulting pulp sample was then packaged for analyses.
- The analytical samples were transported to the CPP laboratory for analysis.
- Once analyzed, the remaining pulp were boxed by drill hole and stored at the secure Wooley Valley storage facility.
- Other than a few pulp duplicates selected by the geologist in charge, no field QA/QC samples (blanks, standards, duplicates and so forth) were submitted with the sample batches. An external check assay was performed on a selection of samples in 2016 using an independent third-party laboratory, SGS Denver (SGS). Further, it was noted that Conda began inserting field QA/QC samples during their 2019 exploration program, however, none of this information was ready in time to include in the Mineral Resource.

Sample shipping and analyses procedures for the samples from RC drill holes for the Itafos Conda projects included the following:

- All samples collected for grade analyses were submitted to the CPP onsite laboratory.
- Primary analyses at CPP laboratory included the following:
 - Major oxides and select trace elements using ICP-OES.
 - Analytical packages varied by project and exploration year, with the following oxides and elements available by project:
 - RVM: P₂O₅, Al₂O₃, MgO, Fe₂O₃, CaO, Cd, Cr, Cu, S, K, Ni, Si, Ti, V, Y, Zn
 - LCM: P₂O₅, Al₂O₃, MgO, Fe₂O₃, Cd
 - NDR: P₂O₅, Al₂O₃, MgO
 - H1: P₂O₅, Al₂O₃, MgO, Fe₂O₃, CaO, Cd, Cr, Cu, S, K, Ni, Si, Ti, V, Y, Zn:
 - Analysis for the samples for the SMCM included in the H1 model were limited to P₂O₅, MgO and LOI
- CPP laboratory internal QA/QC on exploration samples included MIST 694 P₂O₅ Standard (30.2% P₂O₅) for ICP-OES calibration and WPO 43 Standard (31.7% P₂O₅) for internal checks. Lab duplicates were run approximately every 20 samples.
- During several programs, pulp rejects from a selection of samples providing spatial distribution coverage as well as coverage across the grade ranges reported from the CPP results were sent to a secondary external laboratory for check assay purposes as part of the analytical QA/QC program.
- The CPP laboratory provided the data in tabular format to Conda geology personnel. A printed copy of the tabular laboratory results is stored in binders in the CPP technical library.
- Formal laboratory certificates are not prepared by the CPP laboratory.

Golder believes that the QA/QC procedures in place relevant to sampling the core are adequate to provide confidence in the data collection and processing. These QA/QC controls include:

- Project geologist review of all sample markups prior to sampling.
- Core photographs that include sample markups prior to sampling.

However, one key item that is missing from the Itafos Conda procedures is the inclusion of field inserted analytical QA/QC sampling. This was primarily driven by the fact that at the time the data was collected, the exploration drilling programs were designed as operational support rather than with the focus on public disclosure. The lack of this QA/QC control during previous exploration efforts is understandable given the objectives of those programs. Golder does not feel that this QA/QC deficiency materially effects the confidence of the data provided.

The Itafos Conda exploration sampling procedures were modified during the 2019 metallurgical drilling program to ensure appropriate sampling and analytical QA/QC controls were introduced to the process; the QA/QC methods applied to the PH sampling and analytical programs are a good foundation and should be reviewed and modified as appropriate for inclusion in future Itafos Conda exploration and resource delineation programs.

Overall, Golder believes that the methodologies being used by the Itafos Conda geological and exploration teams are within industry standards for sample preparation, quality control employed before dispatch, process of sample splitting and reduction, and security of samples to ensure that validity and integrity of samples is upheld. Golder reviewed these methodologies and procedures while on site.

11.2 PH Project Sample Preparation

Golder reviewed the sampling procedures outlined in the Paris Hills Agricom Inc. Exploration Drilling Procedures, Updated, dated January 26, 2016, and is in general agreement that the drilling procedures are completed to industry standards based on the procedures outlined in the document.

Core sampling procedures for identifying samples for PH include:

- Starting at the top of the hole, identify samples that are approximately 1 foot in length in the UPZ and LPZ:
 - Sampling for the UPZ must begin at least 10 feet above and continue at least 10 feet below the UPZ.
 - Sampling for the LPZ must begin at least 10 feet above and continue at least 5 feet below the LPZ.
- Do not sample across different lithologies, make a new sample if a new lithology is encountered.
- Do not sample across areas of poor recovery / lost core, make a new sample for poor core recovery.
- Mark samples with plastic sample markers and record the sample interval.
- Mark locations for standards, blanks and core duplication. The below are required for each UPZ and LPZ ore zone:
 - Two blanks:
 - One Blank #2 (fine sand, given a B suffix).
 - One Blank #3 (crushed quartz, given a D suffix).

- Two standards:
 - One Florida Check 22 Sample (1/2 of a sample vial), given an A suffix.
 - One Idaho 694 Standard (1/3 of a sample vial), given an A suffix.
- Two duplicates:
 - At least one should be in the higher-grade part of the ore zone.
- Mark plastic sample marker with sample numbers.
- In the sample book, record the project, hole number, date, sample interval, a brief soil/rock description and the suffix. The sample suffixes include:
 - A – Pulp
 - B – Coarse Reject
 - C – Quarter Core
 - D – Half Core
 - E – Whole Core
- Project Geologist review.
- Photograph core.
- Prepare sample bags with sample number and suffix. Remove tags from sample books and place in correct bags. Put each sample number with suffix on a piece of surveyor's ribbon and place in the correct sample bag.

Core sampling procedures for removing the core samples for PH include:

- Starting at the top of the core, remove the 'E' (whole core) suffix core in its entirety and place it in the properly labeled sample bag.
- 'D' (half core):
 - Starting at the top end of the core, remove the row or segment of core that needs to be split, using the sleeve to carefully lift it from the box.
 - Shrink wrap the core for one sample at a time.
 - Place the shrink-wrapped core in the saw and cut the sample in half.
 - Place one half in the sample bag, the other half back into the core box. Remove shrink wrap from core that is to be tested.
 - Wash core saw tray and blade.

- 'C' (quarter core) – Duplicate Sample:
 - Starting with the shrink wrapped 'D' core, shrink wrap again to seal the cut side of the core
 - Place the shrink-wrapped core in the saw, and cut the sample in half
 - Place one quarter of the core in each duplicate sample bag
 - Wash core saw tray and blade
- Standards:
 - Standard amounts:
 - Florida Check 22 Standard, use ½ vial for each standard sample
 - Idaho 694 Standard, use 1/3 vial for each standard sample
 - Place standard material in sample bag
- Blanks:
 - Scoop several hundred grams of blank into the labeled sample bag

Core sampling procedures for preparing samples for shipping for PH include:

- Prepare chain-of-custody forms that include the following: list of all samples included, batch breakdowns, and any special instructions, and shipping address
- Check off each sample on the chain-of-custody form as the sample is placed into the grain sack
- Record the unique ID number from each red security seal on the chain-of-custody form
- Label each grain sack with the range of sample numbers contained in the sack and the number of samples.

Core sampling procedures for shipping samples for PH include:

- Samples must be collected by authorized PH personnel and delivered to the laboratory responsible for sample preparation and/or analysis
- Samples must be kept secure and be sealed with a uniquely numbered security seal
- Upon delivery, the PH personnel relinquishing the samples and the laboratory person receiving the samples must sign the chain-of-custody form
- All paperwork must be properly organized and archived as part of the tracking system with regard to sample identification, method of transport, and final destination

Core sampling procedures for analyzing the samples for PH include:

- Samples were sent to IAS EnviroChem Laboratory, an independent commercial laboratory, located at 3314 Pole Line Road, Pocatello, ID 83201.
- Samples were sent to Thornton Laboratory, an independent commercial laboratory, located at 1145 E. Cass Street, Tampa, FL 33602.
- Samples were sent to Jacobs Engineering, an independent commercial laboratory, located at 3149 Winter Lake Rd, Lakeland, FL 33803

Golder believes that the QA/QC procedures in place relevant to sampling the core are adequate to provide confidence in the data collection and processing. These QA/QC controls include:

- Project geologist review of all sample markups prior to sampling
- Core photographs that include sample markups prior to sampling
- The inclusion of standards, blanks, and duplicates in each ore zone, in each hole

Golder believes that the methodologies being used by the PH geological and exploration teams are within industry standards for sample preparation, quality control employed before dispatch, process of sample splitting and reduction, and security of samples to ensure that validity and integrity of samples is upheld. Golder reviewed these methodologies and procedures while on site and believes that they are being carried out as described in the Paris Hills Agricom Inc. Exploration Drilling Procedures, Updated dated January 26, 2016.

11.3 QP Statement on the Adequacy of Sample Preparation, Security and Analytical Procedures

It is the Golder QP's opinion that the sample preparation, security, and analytical procedures applied by Conda and its predecessors at the Itafos Conda projects and the PH Project are appropriate and fit for the purpose of establishing an analytical database for use in grade modeling and estimation of Mineral Resource estimates as summarized in this TR.

It is the Golder QP's opinion that the significant differences between the sampling, sample preparation, security, and analytical procedures between the Itafos Conda projects and the procedures applied at the PH Project are in large part due to how the projects fit in the operational framework of the company at the time the bulk of the exploration work was being performed.

Until this TR, Mineral Resources have not been publicly disclosed for the four Itafos Conda projects by Itafos Conda and its predecessors, and much of the exploration and resource delineation work performed by Conda was viewed as ongoing internal operations support work rather than being performed with public disclosure in mind. This led to limited formal documentation of procedures, reliance on in-house laboratory analyses, and limited analytical QA/QC programs relative to what is typically observed in public disclosure focused projects.

The exploration and resource delineation efforts for the PH Project were implemented by Paris Hills Agricom Inc. with a focus on public disclosure of the results at various stages along the way of the project. In that regard, a

focus on documentation of procedures, following industry standard procedures on analytical QA/QC, analyses at independent laboratories and other similar considerations were integral to the PH studies throughout its project life.

Formal documentation of procedures was established for the 2019 metallurgical drilling program at H1 and Golder recommends that this continue to be applied across all five projects in order to allow for a more consistent basis for future public disclosure. Industry standard QA/QC programs, including at a minimum, regular insertion of field blanks, standards and duplicates as well as laboratory replicates and check assay analyses were incorporated into the H1 metallurgical drilling program and are recommended for all future drilling programs at the Itafos Conda projects and the PH Project alike in order to further improve the confidence in the underlying data and to provide a more complete disclosure of methods and results.

12.0 DATA VERIFICATION

The following Items describe the data verification procedures applied by the Golder QP, any limitations on or failure to conduct such verification, and the reasons for any such limitations or failure; and the QP's opinion on the adequacy of the data for the purposes used in this TR.

The CIM Mineral Exploration Best Practice Guidelines (2018 edition), data verification is related to the integrity and accuracy of the data to represent results that are reasonable. All data that are to be included in a project database should be checked. This includes "legacy" data of any type: geochemical, geophysical, drilling, sampling, metallurgical, and so forth from previous operators or government agencies. The focus is on validating the accuracy and verifying the suitability of information collected during previous works before using it for the purpose of developing geological databases, geological models and preparing Mineral Resource estimates.

In addition to performing data verification of the underlying data and documentation for historical data, Golder also performed data validation. In accordance with the CIM Mineral Exploration Best Practice Guidelines (2018 edition), data validation includes all necessary checks to make sure there were no errors or mismatches in the data (e.g., overlapping samples, mislabeling of data, mixed units, and so forth), but does not include verification of the underlying data addressed in the data verification process.

The data verification procedures, limitations and statements of data adequacy for historical data collected by Conda and its predecessors are addressed separately in each of the following Items.

12.1 Data Verification Procedures

QP Site Visits

The Golder QP performed two current personal inspection site visits for the Project. The first site visit took place from April 15 through April 18, 2019, while the second site visit took place from September 17, 2019, through September 18, 2019. The first site visit focused on a review of the current operations, data collection methods from previous programs as well as data transfer for the Project, while the second site visit was focused on QP oversight and review of current drilling, logging, sampling, and chain of custody procedures for the 2019 H1 metallurgical drilling program that was underway at the time.

General activities conducted during each of the site visits were as follows:

- Site visit 1 – Conducted by Golder's resource geology and mining engineering QPs:
 - General overview of exploration and mining operations at the Itafos Conda projects and the PH Project with Conda senior management team.
 - Observe current mining operations at the RVM and LCM pits. This included observing grade control methods, ore and overburden separation and handling processes, transport to ex-pit overburden dumps and ore stockpiles and backfilling and reclamation procedures.
 - Observe stockpiles and ore train loading procedures at the tipple.
 - Visit the Wooley Valley shop to review drill core and chip cuttings from the 2012 exploration program at NDR and H1. Also reviewed the storage procedures for older cuttings and sample rejects stored at the facility.

- The Golder QPs were not able to visit the NDR and H1 sites due to heavy snowfall accumulation and poor road conditions due to snow melt on the two properties.
- Reviewed data collection, processing, interpretation, modeling and estimation procedures for the Itafos Conda projects with mine geology and exploration personnel.
- Reviewed data collection, processing, interpretation, modeling and estimation procedures for the PH Project with mine engineering and geology personnel.
- Visited the PH Project core shed and viewed drill core from one drill holes from the 2010-2012 PH drilling program.
- Visited the PH Project site for a general overview of the site and access; however, the Golder QPs were not able to travel around the property due to combination of snow accumulation in areas and poor road conditions from snow melt.
- Visited the Dry valley shop to review RC drill hole logging and sampling procedures, including RC chip sample preparation and packaging procedures.
- Visited the CPP onsite laboratory to review sample receiving, sample preparation, analysis, QA/QC procedures and sample and reject storage procedures.
- Site Visit 2 – Conducted by Golder’s resource geology QP:
 - General overview of the progress on the metallurgical bulk sample drilling program with Itafos Conda mine geology, exploration personnel and drilling and metallurgical contractors involved in the project.
 - Visited the H1 property to view the active drilling and core logging. Observed drill site and core shed geologists during core recovery, visual logging, sample identification and sample selection procedures.
 - Reviewed core sample packaging and chain of custody procedures with core shed geologists.
 - Visited the locations for four planned metallurgical drill holes on the NDR property that were subsequently postponed until the 2020 drilling season due to weather conditions ending the 2019 campaign in early October 2019.
 - Reviewed drill hole closure and reclamation procedures with the Itafos Conda team.

During the second site visit the Golder QP visited collar locations for seven existing drill holes on the H1 property and five existing drill holes on the NDR property. While most Itafos Conda exploration drill holes have been reclaimed shortly after drilling, the drill holes visited by Golder had been converted to water monitoring wells. All were clearly identified by steel casing with drill hole numbers clearly inscribed on the casing. The drill collar positions were checked by the Golder QP using a handheld non-differential GPS and the collar positions were found to be within the allowable tolerances given the relative precision of the original survey and the handheld GPS.

The site visits were a key part of the data collection methodology verification process conducted by Golder as they allowed for direct discussion of methods and procedures employed by the Conda personnel involved in the exploration projects. Golder was also able to observe examples of the retained RC chips, drill core and sample

rejects for various past exploration drilling campaigns. The laboratory visit was also important in verifying that the samples were received, prepared and analyzed using appropriate industry standard procedures.

Drill Hole Data Verification

Golder compiled all tabular drill hole and analytical data provided by Conda into a digital relational database for each of the five projects; data for the Itafos Conda projects (modeled in Vulcan™ and Leapfrog™) was compiled in Vulcan ISIS databases while data for the PH Project (modeled in MineScape™) was compiled in an MS Access™ database. The five individual drill hole databases were then used as the basis for the data verification and data evaluation processes described in the following sub-Items. Verified data was then exported from these five databases for the purpose of constructing the geological models and preparing Mineral Resource estimates, as described in later Items of this TR.

Golder performed a series of routine geological data integrity checks on the drill hole databases for each of the five projects to check for common errors and omissions in geological data including but not limited to the following:

- Identify duplicate or twinned drill holes with identical collar positions.
 - If any pairs of drill holes were identified from this data validation check, then Golder systematically reviewed the pairs and selected the drill hole with the more accurate or complete geological data to be included in the model.
- Check drill hole collar elevation against topography elevation:
 - Due to low confidence in the accuracy of the topographic models for 2 out of the 5 projects, as discussed later in this Item, along with mining activity related post-drilling modifications to the topographic surface in several areas, no drill holes were excluded based on topography versus surveyed collar position discrepancies.
- Check that total hole depths on the collar table match the total depth of the lithological table:
 - If any did not match, Golder reviewed downhole geological data as well as drilling records to reconcile the difference. Once the error was identified, the erroneous data field was corrected.
- Check that from and to depths from surface on the lithology and assay tables increase down hole:
 - If any did not match, Golder reviewed downhole geological data to correct the errors.
- Identify drill holes, which had no lithological, assay, survey, or wireline natural gamma ray logs (gamma logs):
 - Any drill holes missing all geological data were excluded from the geological model since they had no data to model and would cause false bull's eyes and structural anomalies.
- Review Lithological Bed correlations for consistency and correct stratigraphic sequencing:
 - Any errors seen in the database were reviewed with original geological data and corrected.

- Check for data entry errors in collar survey and downhole survey records:
 - Data entry errors including gaps in records and overlapping records were identified and fixed based on original geological data as required. Golder also verified that drill holes loaded into the geological models matched general locations and layouts provided in base maps from Conda.

After the initial drill hole database validation, collar survey and downhole geological unit intervals, sample intervals, wireline gamma logs and analytical results were imported into a Strater™ project and a graphic downhole log was prepared for each drill hole. The graphic drill hole logs were used to facilitate visual inspection of each drill hole with regard to:

- Lithologic unit and assay sample depths matching appropriately.
- Lithologic unit and assay sample values matching appropriately.
- Lithologic unit and gamma logs matching appropriately (where gamma logs were available).

Additionally, the Strater™ project was used to complete a review of correlations of geological units and mineralized zones between adjacent drill holes through the generation of fence diagrams along strike and down dip.

Minor errors, omissions or proposed revisions were identified by Golder during the review process; these included typographic errors and omission of some data and observations as well as some minor re-correlations of geological units to honor the grade data. While minor, these errors, omissions or revisions were material. In each instance the error, omission or revisions were reviewed with Conda senior geologists and any updates to the data were incorporated into the final geological databases to be used for modeling.

Grade Data Verification

In addition to the general database integrity checks discussed in the previous Item, Golder performed a review of the analytical grade data provided by Conda to ensure it was reliable, representative and free of any significant errors or omissions. The grade data verification checks included but were not limited to the following:

- Check for from/to depth overlaps in lithology table.
- Check assay sample table for overlaps in from/to depths.
- Check that grade sample intervals corresponded with lithology bed pick roof and floor intervals.
- Check that assay grade values were between 0% and 100%.
- Check that grade values did not total greater than 100% for an individual sample.
- Evaluate grade values against drill hole recovery data.

As part of Golder's standard analytical data reviews, tabular grade data is compared against signed assay certificates from the laboratories that performed the analytical test work to ensure the tabular data is free from transcription errors or omissions. However, with the exception of PH samples collected during the Paris Hills Agricom Inc. core drilling programs and a small number of Itafos Conda QA/QC samples that were performed at independent third party commercial laboratories, the bulk of the grade data for the Itafos Conda projects were derived from analytical test work performed at Conda's in-house analytical laboratory located at their CPP and were provided in printed tables and spreadsheet format; signed analytical certificates were not generated by the Conda onsite laboratory.

The Golder QP visited the CPP Analytical Laboratory during the Project site visit in April 2019 and it was the opinion of the QP that the documentation, procedures, testing equipment, testing facilities and controls in place for the onsite laboratory meet industry standards. Sample preparation and analytical instruments and procedures were consistent with those observed at other operations and commercial analytical laboratories and hence, there were no identified concerns during the visit.

It is the Golder QP's opinion that the analytical results from the Itafos Conda exploration programs analyzed have been consistent with the realized grades from the active mining operations at RVM and LCM. This opinion was formulated by comparing drill hole assay values that were in mined-out areas to production data as well as against quality control data provided from the mine stockpiles, trains, CPP stockpiles, and the wash plant and acid plant at the CPP.

In an effort to validate the CPP Analytical Laboratory, Conda completed a duplicate testing regime where 25 samples from H1 and 28 samples from RVM were analyzed at both the Conda CPP laboratory and at the independent commercial SGS laboratory in Denver Colorado (SGS Denver). Golder reviewed the results from this regime and found that except for a few outliers, the two data sets were within acceptable tolerances for duplicate analyses. Except for the outliers, the Golder data comparison results are as follows:

- P₂O₅ relative differences of less than +/- 2% (mean of 0.4% difference) .
- MgO relative differences were less than +/-1% (mean of 0.1%).
- The H1 P₂O₅ dataset showed no clear high/low bias between the two laboratories.
- The RVM dataset showed minor differences, but a consistent bias towards slightly higher grades from SGS Denver analyses, suggesting the CPP P₂O₅ results may be slightly conservative.

As independent commercial laboratory certificates were available for the PH analytical data set from a series of independent commercial laboratories including ALS Chemex, Jacobs Engineering, EnviroChem, and Thornton Laboratories. The database assay values for all PH samples were visually compared to the laboratory assay certificates to ensure the tabular assay data was free of errors or omissions for each hole. No typographic errors or omissions were identified in the tabular data during the review of the assay certificates. It should be noted that the early in the PH exploration program, the ALS data was deemed flawed by Paris Hills Agricom Inc. in that ALS reported P₂O₅ grade values that were biased high by several percent based on analysis of QA/QC standards included and as a result the ALS data was excluded from the modeling database during both previous and the current studies. All ALS data was reanalyzed by at least one of the remaining three laboratories.

Historical Drilling Data Verification

In the PH Project, additional historical drilling data was available from drill programs conducted by ESI in the 1970s, which included stratigraphic and assay data. However, due to insufficient documentation and poor reliability of data, only 11 of 47 ESI drill holes were used by Golder for stratigraphic and structural modeling. The ESI drill holes were not used by Golder as points of observation when estimating measured, indicated, and inferred areas for resource tonnage estimation. Once the ESI drill holes were loaded into the Golder geological model, Golder thoroughly reviewed their influence on surrounding drill holes and excluded ESI drill holes that were causing unverifiable structural anomalies. The ESI drill holes in the Golder geological model have a prefix of ESI.

Analytical results from the ESI programs were not reviewed or included in the PH analytical data set that was utilized for assay modeling by Golder due to their poor documentation and uncertainty regarding reliability.

Other Data Verification

Golder performed high level reviews of the topographic data and topographic surface models for the five projects using the drill hole collar elevations as spot checks against the topographic model elevations. The summary statistics for collar elevations versus topographic (original topography) elevations are presented by project in Table 12-1.

Table 12-1: Collar Elevation versus Topographic Elevation Summary Statistics

Project	Drill Hole Count	Absolute Elevation Difference (collar - topographic surface, feet)				
		Minimum	Maximum	Mean	Median	90th Percentile
RVM	210	0.0	10.3	2.8	2.3	5.8
LCM	68 ¹	0.0	21.5	2.4	1.2	6.0
NDR	293	0.0	193.5	7.5	5.0	13.6
H1	302	0.0	162.4	14.5	4.5	41.6
PH	54 ²	0.0	3.8	1.8	1.7	3.1

Notes:

- 1: Identified in-pit drill holes and trenches have been excluded from statistics.
- 2: ESI drill holes excluded from statistics.

Drill hole collar elevations versus topographic model elevations appeared to be reasonable for the RVM, LCM and the PH Project. However, for the RVM and LCM models, there were some difficulties confirming the exact topographic surface elevation at the time of drilling as these areas have been undergoing surface mining and ex-pit surface disturbances associated with mining activity that spans the various drilling campaigns. Current topographic surveys in and around the RVM and LCM pits are deemed to be reliable as they are surveyed regularly by Itafos Conda as part of ongoing mining operations.

Several different public domain topographic surfaces were reviewed for the NDR and H1 projects, and while sufficient for the purpose of preparing PEA level geological models and resource estimates, more reliable and higher resolution topographic data must be collected in the future to allow for the development of a topographic model of sufficient resolution to allow for detailed open pit mine design, scheduling, and other associated design and development work on these projects.

Based on the comparison with the drill hole data, the topography was deemed to be suitable for the purpose of estimating Mineral Resources.

12.2 Limitations on Data Verification

The Golder QP was not directly involved in the exploration drilling and sampling programs that formed the basis for collecting the data used in the geological modeling and mineral resource estimates for the five projects in this Project. As a result, the Golder QP was not able to observe the drilling, sampling or sample preparation while in progress and therefore Golder has had to rely upon forensic review of the exploration program data, documentation and standard database validation checks to ensure the resultant geological database is representative and reliable for use in geological modeling and Mineral Resource and Reserve estimation.

Subsequent to the initial QP site visit, the Golder QP was on site for a current drilling program in September 2019 that was intended to collect metallurgical bulk sample material for ongoing metallurgical studies on the NDR and H1 projects. During this site visit, the Golder QP was able to observe the standard Conda drilling, logging and sampling procedures, the majority of which were reported to be similar to those procedures employed by Conda during the exploration programs used to collect the data that forms the basis for this Project.

The recent metallurgical drilling and sampling programs that were observed by the Golder QP on the September 2019 site visit were performed under the supervision of the same senior Itafos senior geologist and using the same exploration consulting team as the previous Itafos Conda exploration programs that were carried out for the Project.

While on site in September 2019, the Golder QP noted that the metallurgical drilling and sampling programs were executed to appropriate industry standards with regard to depth measurement, sample collection, and sample storage. This provided the Golder QP added confidence that the previous exploration drilling programs that were managed by Conda's current geological team were also likely executed to a similar industry standard.

Golder did not perform any independent drilling or collection of samples for independent analyses on the Project.

12.3 QP's Statement on Adequacy of Data

The Golder QP has verified the data disclosed, including collar survey, downhole geological data and observations, wireline gamma logs, sampling, analytical, and other test data underlying the information or opinions contained in the written disclosure presented in this TR. The QP, by way of the data verification process described in this Item of the TR, has used only that data, which were deemed by the QP to have been generated with proper industry standard procedures, were accurately transcribed from the original source and were suitable to be used for the purpose of preparing geological models and Mineral Resource estimates. Data that could not be verified to this standard were reviewed for information purposes only but were not used in the development of the geological models, or Mineral Resource estimates, presented in this TR.

13.0 MINERAL PROCESSING AND METALLURGICAL TESTING

Note, for this Item 13.0, the superscript references included in this Item pertain to the following works cited:

1. (SGS Laboratories, November 5, 2013, pp. 59)
2. (Pilon, Richard, July 30, 2012, pp. 33)
3. (Pilon, Richard, November 28, 2013, pp. 32)
4. (Agrium Nutrients, n.d., Historical Plant Description)

No ore processing occurs at any of the mineral projects. However, phosphate ores to be mined and delivered must be suitable for the CPP. Suitable for consumption means that delivered phosphate ores may be blended, if needed, and washed to meet certain quality characteristics required of the chemical plant feed. This Item includes information on the CPP Wash Plant that is used to process RVM and LCM ores to meet the requirements of the CPP, and the mineral processing and testing that has been conducted to characterize the RVM and LCM ores as suitable for the CPP.

Itafos Conda operates the CPP at Soda Springs, Idaho. The CPP includes the Wash Plant, the Ball Mills for the fine milling of the phosphate rock, the Phosphoric Acid Plant (PAP), and the SPA and MAP facilities. The Wash Plant operation starts with the reception of trains hauling phosphate ore from the mines and the phosphate ore distribution and storage to feed the beneficiation process (washing) and ends with grinding of the phosphate rock in the ball mills. The Wash Plant also includes the operation of the tailings pond area. The CPP Wash Plant has been operating for more than 50 years, demonstrating a flexible and sound operation with no critical risks.

Over the course of these years, several businesses that owned the CPP developed and mined different zones of southeast Idaho's phosphate area, with the Wash Plant being able to blend and handle different phosphate ore qualities; run-of-mine (ROM), B+, High MgO, and High Al. This allowed the Wash Plant to be fed under stable ore quality. Under a stable ore quality, the Wash Plant produces a phosphate rock or concentrate suitable to produce the desired MAP, SPA and APP at the PAP.

The existing Wash Plant and the historical analysis of its operations provided the basis for assumptions made with regards to recovery estimates. Specifically, it consisted in reviewing the testing and analytical results of phosphate ore and beneficiated products and studying of the Wash Plant operations during the years 2018-2019. A summary of the results is presented at the end of this Item. The Wash Plant processes an average of 350 tph (dry) of phosphate ore, producing 238 tph of phosphate rock to feed the PAP. The Wash Plant requires well blended phosphate ore to be fed with >25% P₂O₅, 0.72% to 1.20% MgO, and <20.00% SiO₂. The produced phosphate rock fulfills the required specifications to feed the PAP, >30% P₂O₅, <0.60% MgO, and about 10% SiO₂.

This Item describes the fundamentals of the metallurgical unit operations of the Wash Plant including the ball mills that supports the operation and feeds the PAP. For this purpose, this Item includes a discussion of the phosphate ore feed preparation, ore characterization studies, main unit operations, metallurgical balance for the 2018-2019 period, and summary and conclusions.

13.1 Phosphate Ore Feed Preparation

The phosphate ore is characterized (P₂O₅ grade and quality) via chemical analyses using bench-channel sampling, sampling and chemical analyses of the mine stockpiles, and using a belt pressure air sampler of the partially blended phosphate ore. Unit trains haul this partially blended ore from the mines. Each unit train is loaded with a defined type of phosphate ore to include ROM, B+, High MgO, and High Al.

These unit trains have a nominal payload of 13,300 tons (133 cars of 100-ton capacity each) and haul six days a week for 30 weeks per year (April through October). Upon arriving at the CPP, the unit trains are unloaded one car at a time by a “rollover” dumper. Here, an additional sample is obtained to check the quality of the phosphate ore received from the mine. The unloaded phosphate ore is then redirected by belt conveyors and stackers to the corresponding ROM, B+, High MgO, and High Al stockpiles (see Figure 13-1).

Figure 13-1: Rollover, Belt Conveyors, Stackers, and Stockpiles



Dozers are used to build and move the inventory stockpiles and to reclaim the ore from each stockpile to prepare a blended feed for the hopper to the Wash Plant. This blended feed phosphate ore is screened over an 8-inch screen. The +8-inch material (+203,200 μm) is recycled to the stockpiles, while the -8-inch size fraction (-203,200 μm) serves as the actual Wash Plant feed.

At this point, another feed sample is obtained at the feed hopper/feed belt conveyor and sent to the Chemical Lab, where it is analyzed by ICP-OES, who determines moisture content of the sample and conducts a simulation of the Wash Plant's performance.

13.2 Summary of Phosphate Ore and Products Characterization Studies

This Item presents the phosphate ore and beneficiated products characterization studies for the years 2018-2019 (unless otherwise indicated) to understand the Wash Plant operation and to demonstrate the feasibility of continued production of suitable Wash Plant products for the PAP. These products include the beneficiated product (Wash product, concentrate, or phosphate rock), tailings, recycle water, and ball mill grinding of the beneficiated product for the PAP.

13.2.1 Wash Plant Feed – Head

The average feed chemical analysis for the years 2018 and 2019 is presented in Table 13-1. The P₂O₅ feed grade is 25.49% with a 36.51% CaO grade, resulting in a CaO/P₂O₅ Ratio of 1.43. Since pure fluor or hydroxy-apatite, shows a CaO/P₂O₅ Ratio of 1.32 to 1.38, the presence of calcium carbonates is not significant in the phosphate ore. The Minor Elements Ratio (MER), Al₂O₃, Fe₂O₃, and MgO, is 0.205 for the period, which is indicative of the presence of impurities, such as aluminum silicates, clays, and iron bearing minerals. The high contents of Al₂O₃ (3.31%), Fe₂O₃ (1.27%), and SiO₂ (19.81%) support this observation.

Table 13-1: Wash Plant Feed – Chemical Analysis (2018-2019)

H ₂ O, %	10.12
P ₂ O ₅ , %	25.49
CaO, %	36.51
MgO, %	0.65
Al ₂ O ₃ , %	3.31
Fe ₂ O ₃ , %	1.27
SiO ₂ , %	19.81
K ₂ O, %	1.02
Cd, ppm	102
Cr, %	0.10
Cu, ppm	108
Ni, ppm	174
Ti, %	0.13
CaO/P ₂ O ₅ Ratio	1.432
MER	0.205

13.2.2 Wash Plant Feed – Screen Assays

A screen assay of the Wash Plant feed was obtained on June 19, 2019. This analysis was performed to determine the relationship between the different elements and compounds of present and future phosphate ore feed to the Wash Plant.

Table 13-2 presents the screen analysis and screen assay of the Wash Plant feed. The results for the -400-mesh material (-37 µm) were obtained by difference from the corresponding daily feed chemical analysis. The information contained in Table 13-2 and plotted in Figure 13-2, Figure 13-3, and Figure 13-4 compares the screen analysis to that obtained from previous mineralogical analyses conducted in similar phosphate ores deposits of the same area (see 13.2.3 Wash Plant Feed-Mineralogy).

Table 13-2: Screen Analysis and Screen Assay of the Wash Plant Feed of June 19, 2019

SCREEN ANALYSIS						GRADE					
MESH	Opening	Wt	Wt	Cum Wt	Passing	P ₂ O ₅	MgO	Al ₂ O ₃	Fe ₂ O ₃	CaO	SiO ₂
	µm	g	%	%	%	wt%	wt%	wt%	wt%	wt%	wt%
+3/8"	9525	14.70	4.71	4.71	95.29	12.31	8.19	2.53	0.86	30.92	16.92
+1/4"	6350	54.70	17.53	22.24	77.76	20.15	2.49	2.88	0.90	34.49	20.53
+6m	3360	32.60	10.45	32.69	67.31	26.39	1.16	2.22	0.78	40.46	15.48
+16m	1190	34.80	11.15	43.85	56.15	28.41	0.89	2.04	0.73	42.38	13.74
+ 35m	500	15.30	4.90	48.75	51.25	32.02	0.54	1.38	0.59	47.38	9.06
+50m	297	15.00	4.81	53.56	46.44	34.00	0.29	0.85	0.41	50.01	5.54
+100m	149	26.60	8.53	62.08	37.92	34.57	0.21	0.70	0.34	50.14	4.75
+200m	74	11.20	3.59	65.67	34.33	33.95	0.30	0.75	0.36	49.28	5.56
+270m	53	14.10	4.52	70.19	29.81	31.81	0.50	0.95	0.44	45.02	9.06
+325m	44	5.20	1.67	71.86	28.14	25.76	0.88	1.50	0.49	37.80	20.06
+400m	37	2.10	0.67	72.53	27.47	20.88	1.13	2.11	0.57	30.64	31.98
-400*	6**	85.70	27.47	100.00	0.00	20.87	2.34	6.44	0.82	21.99	35.42
TOTAL		312.00	100.00			25.15	1.80	3.13	0.71	36.14	19.55
DISTRIBUTION						CUMULATIVE DISTRIBUTION					
P ₂ O ₅	MgO	Al ₂ O ₃	Fe ₂ O ₃	CaO	SiO ₂	P ₂ O ₅	MgO	Al ₂ O ₃	Fe ₂ O ₃	CaO	SiO ₂
wt%	wt%	wt%	wt%	wt%	wt%	wt%	wt%	wt%	wt%	wt%	wt%
2.31	21.43	3.81	5.76	4.03	4.08	2.31	21.43	3.81	5.76	4.03	4.08
14.05	24.24	16.14	22.26	16.73	18.41	16.35	45.67	19.95	28.02	20.76	22.49
10.96	6.73	7.41	11.49	11.70	8.27	27.32	52.40	27.36	39.50	32.46	30.77
12.60	5.51	7.27	11.49	13.08	7.84	39.92	57.91	34.63	50.99	45.54	38.61
6.24	1.48	2.15	4.09	6.43	2.27	46.16	59.40	36.79	55.08	51.97	40.88
6.50	0.77	1.31	2.76	6.65	1.36	52.66	60.17	38.09	57.84	58.62	42.24
11.72	0.98	1.92	4.12	11.83	2.07	64.38	61.15	40.01	61.96	70.45	44.31
4.85	0.59	0.86	1.84	4.89	1.02	69.22	61.74	40.87	63.80	75.35	45.33
5.72	1.26	1.38	2.81	5.63	2.10	74.94	63.00	42.25	66.61	80.97	47.43
1.71	0.82	0.80	1.16	1.74	1.71	76.65	63.82	43.04	67.77	82.72	49.14
0.56	0.42	0.45	0.54	0.57	1.10	77.21	64.24	43.50	68.31	83.29	50.24
22.79	35.76	56.50	31.69	16.71	49.76	100.00	100.00	100.00	100.00	100.00	100.00
100.00	100.00	100.00	100.00	100.00	100.00						

Notes:

* Estimated by difference with daily feed Chemical analysis.

** Estimated average particle size of material for data analysis.

Figure 13-2 presents P₂O₅, MgO, Al₂O₃, Fe₂O₃, CaO, and SiO₂ grades as a function of particle size. Even though the results plotted in Figure 13-2 include only grades, important trends can nonetheless be observed. As shown, the grade values of P₂O₅ and CaO increase significantly at the +325 mesh (+44 µm) size fraction, with both curves appearing nearly identical in shape, decreasing at the +0.25-inch (+6,350 µm) size fraction. This may indicate that CaO was contained in a fluor or hydroxy-apatite, and that there was little presence of calcium carbonates (calcite).

In the case of the impurities (MgO, Al₂O₃, Fe₂O₃, and SiO₂), the trend for Al₂O₃ and Fe₂O₃ is virtually identical to grades, increasing at -325 mesh (-44 μm). MgO grades follow the same trend of Al₂O₃ and Fe₂O₃; however, they also increase at +0.25 inch (+6,350 μm), suggesting that MgO (at coarse size fractions) is related to dolomite (magnesium carbonate). The SiO₂ grade curve appears to be a mirror image of the P₂O₅ and CaO grade curves, indicating that SiO₂ was not associated with fluor or hydroxy-apatite, and it may not only be present as quartz, but may be associated with Al₂O₃, Fe₂O₃, and MgO. Analysis of Figure 13-2 indicates that at +0.25-inch (+6350 μm) quartz, dolomite, iron bearing minerals, aluminum silicates, and clay may be present; whereas, at -325 mesh (-44 μm), aluminum silicates, clays, and iron bearing minerals dominate the system. The grade curves indicate that P₂O₅ and CaO appear to be liberated at about 0.25 inch (6350 μm), concentrating at the 0.25 inch x 325-mesh size fraction (6,350x44 μm), with some P₂O₅ and CaO losses reported in the -325-mesh material (-44 μm).

Figure 13-2: P₂O₅, MgO, Al₂O₃, Fe₂O₃, CaO, and SiO₂ Grades as a Function of Particle Size for the Wash Plant Feed – June 19, 2019

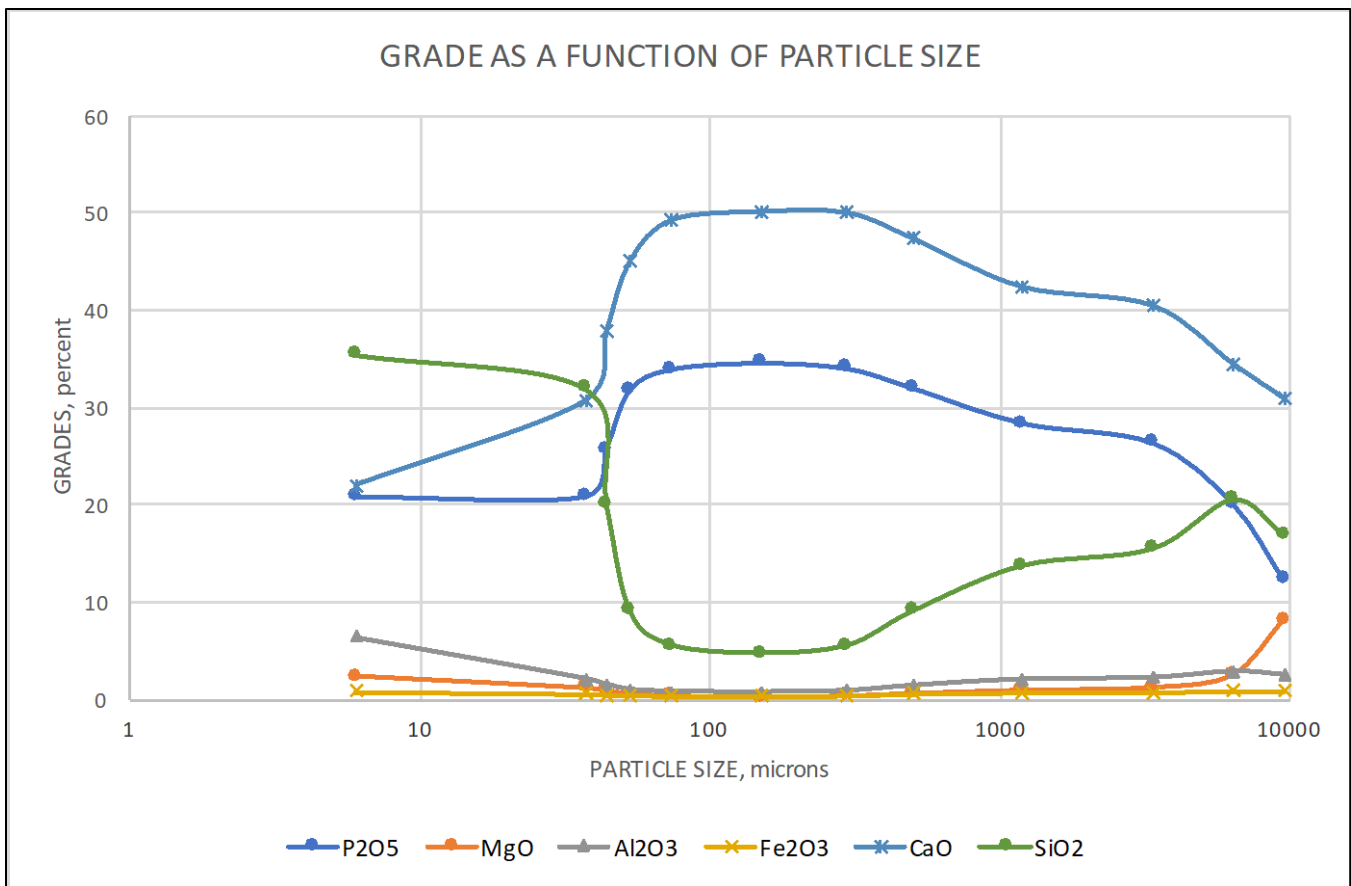

Figure 13-3 shows the distribution of P₂O₅, MgO, Al₂O₃, Fe₂O₃, CaO, and SiO₂. The data shows that materials finer than 325 mesh (-44 μm) contained significantly more impurities (MgO, Al₂O₃, Fe₂O₃, and SiO₂) and less P₂O₅ and CaO. The distribution curves of P₂O₅ and CaO between 325 mesh (44 μm) and 0.25 inch (6,350 μm) were identical, which supports the analysis of the grades curves (Figure 13-2) and indicates the presence of fluor or hydroxy-apatite. The Al₂O₃, Fe₂O₃, and SiO₂ Distribution Curves possess virtually identical shapes between 35 mesh (44 μm) and 0.375 inch (9,525 μm), though the MgO Distribution Curve is slightly different at +0.25 inch

(+6,350 μm). This may indicate the presence of coarse dolomite (magnesium carbonate). The -325-mesh size fraction (-44 μm) indicates that aluminum silicates, clays, and iron bearing minerals are most prevalent at this size fraction.

Figure 13-3: Distribution of P_2O_5 , MgO , Al_2O_3 , Fe_2O_3 , CaO , and SiO_2 as a Function of Particle Size for the Wash Plant Feed – June 19, 2019

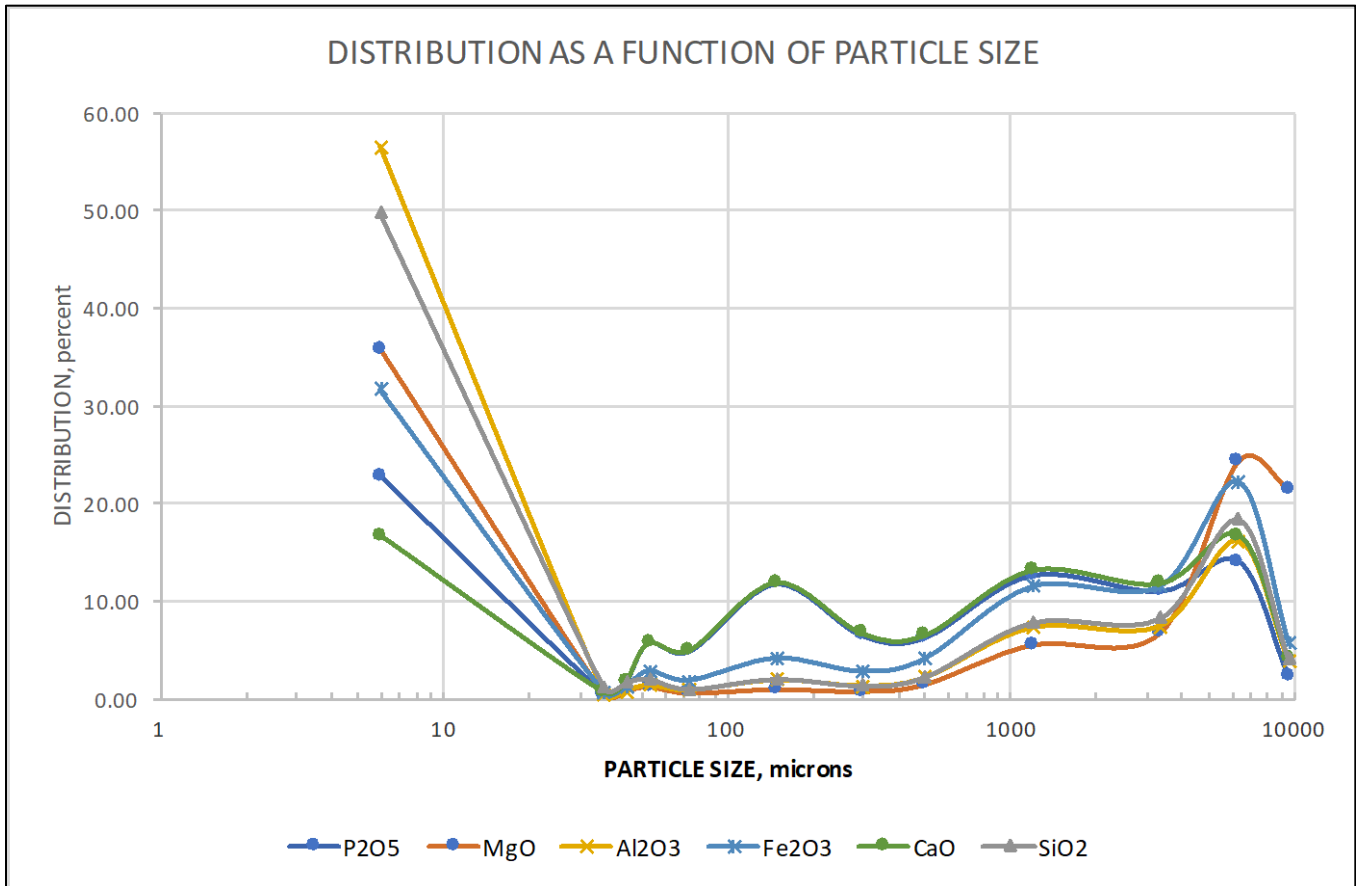
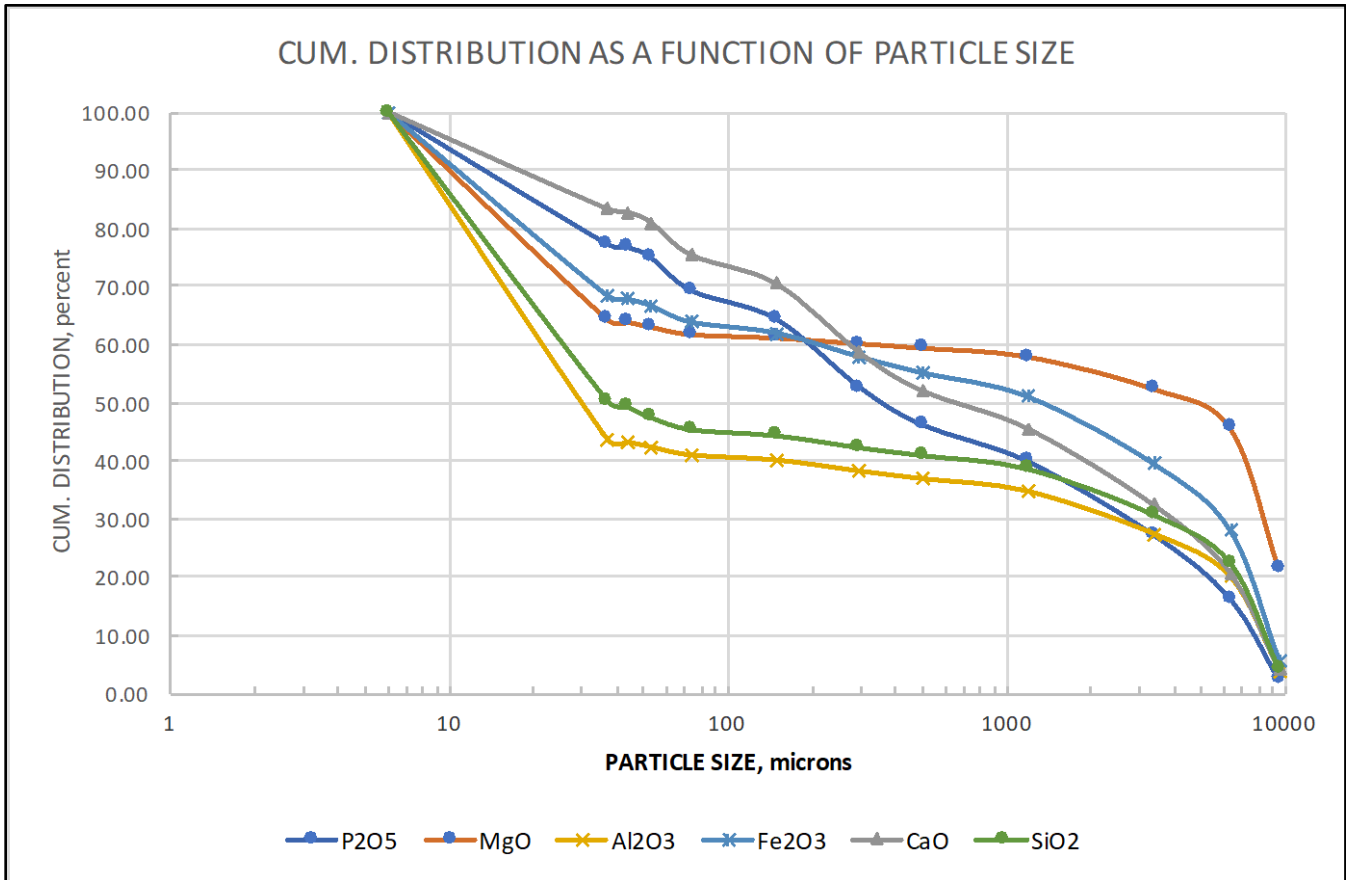

Figure 13-4 presents the cumulative distribution of P_2O_5 , MgO , Al_2O_3 , Fe_2O_3 , CaO , and SiO_2 , which allows for the analysis of the association of the minerals based on the loci of their curves and shapes. The cumulative distribution of P_2O_5 and CaO as two exactly parallel curves indicates that fluor or hydroxy-apatite, was the phosphate mineral. Al_2O_3 and SiO_2 follow the same trend and the loci of the cumulative distribution curves suggesting the presence of aluminum silicates and clays. Fe_2O_3 shows a similar shape of cumulative distribution curve, but the locus of the curve differs. This may indicate the presence of iron bearing minerals in association with aluminum silicates. In the case of MgO , the locus of the cumulative distribution curve suggests large amounts of dolomite at the coarse size fractions, with the +0.25 inch (+6,350 μm) reporting higher values than those of Al_2O_3 , Fe_2O_3 , and SiO_2 , which follows a similar trend for the -0.25-inch (-6,350 μm) material.

In general, the screen assay results indicate that the P_2O_5 mineral was fluor or hydroxy-apatite that liberates at a coarse size fraction of about 0.375 inch (9,525 μm). The results indicate that the content of fluor or hydroxy-apatite in the -325 mesh (-44 μm) is significantly lower than those concentrations of impurities in this size fraction. MgO , as dolomite (magnesium carbonate), is present at coarse size fraction +0.25-inch (+6,350 μm),

and at the -325-mesh (-44 µm) size fraction; whereas, Al₂O₃ and SiO₂ screen assay results suggest the presence of aluminum silicates and clays at -325 mesh (-44 µm). Fe₂O₃ results indicate the presence of iron bearing minerals and iron associated with aluminum silicates and clay.

Figure 13-4: Cumulative Distribution of P₂O₅, MgO, Al₂O₃, Fe₂O₃, CaO, and SiO₂ as a Function of Particle Size for the Wash Plant Feed – June 19, 2019



13.2.3 Wash Plant Feed – Mineralogy

The RVM and LCM phosphate ores are part of a series of deposits in this geological formation that have been mined for more than 50 years. Even though the mineralogical studies were not performed on RVM and LCM phosphate ores, the information obtained from similar phosphate ores mined previously is important in forecasting the behavior of the Wash Plant using RVM and LCM phosphate ores for production of phosphate rock suitable to produce MAP, SPA, and APP in the foreseeable future. Furthermore, the correlation of the screen assay results with the mineralogical studies available confirm that plant processes were adequate for processing the RVM and LCM phosphate ores.

Several mineralogical studies on different phosphate ores were carried out in the past^(1,2,3). The first mineralogical study was done using QEMSCAN on the phosphate ore from the Rasmussen Ridge Mine (Pilon, Richard, July 30, 2012, pp. 33). It was found that the average apatite particle size was 99 µm, resulting in 56.2% of free apatite. The gangue minerals were quartz, orthoclase, and dolomite. In general, good liberation was observed at the 1180 x 600 µm size fraction.

Mineralogical and liberation studies for ore from the North Rasmussen Ridge Mine crushed at 10 mesh (1,651 μm) were performed using QEMSCAN. The ROM material was sized at +300 μm , 300 x 150 μm , 150 x 53 μm , 53 x 20 μm , 20 x 10 μm , and -10 μm . Table 13-3 presents the liberation data analyzed by SGS (SGS Laboratories, November 5, 2013, pp. 59). The results indicate that “combined” apatite (see Table 13-3) was locked only at 0.4%, with the highest amount of locked apatite present in the 53 x 20 μm and 20 x 10- μm size fractions with 2.17% and 1.07%, respectively. “Combined” free apatite was 72% for the sample, with size fractions 300 x 150 μm , and 150 x 53 μm showing 81.00% and 82.60% free apatite, respectively.

Table 13-3: Particle Liberation Data of North Rasmussen Ridge Mine

Apatite	Combined	Particle Size in Microns					
		+300	300x150	150x53	53x20	20x10	-10
Locked	0.40	0.28	0.26	0.27	2.17	1.07	0.39
Submiddling	1.90	1.56	1.25	1.06	5.96	4.67	3.25
Middling	8.80	5.79	4.18	3.88	10.50	15.60	30.60
Liberated	15.90	17.60	13.30	12.20	8.27	22.10	27.90
Free	72.00	74.80	81.00	82.60	73.10	56.60	37.80

The Theoretical Recovery Curve shows that it is possible to obtain a 37% P_2O_5 with 95% recovery of P_2O_5 at +53 μm assuming a perfect separation efficiency for the beneficiation process used. These mineralogical studies indicate that the phosphate ore of this deposit correlates well with the information obtained from the screen assays for the RVM and LCM phosphate ores. Thus, it confirms that the phosphate mineral is fluor or hydroxy-apatite, (apatite) whether free or impure, with the presence of aluminum silicates and clays, iron bearing minerals, and dolomite and quartz, or carbonate/silica cement, mainly at -325 mesh (-44 μm), and coarse dolomite at +300 μm . Even at 1180 x 600- μm size fraction, liberation appears strong.

These characterization results of the plant feed show that the Wash Plant, which includes scrubbing, sizing, rod mill grinding, classification and dewatering performs satisfactorily for RVM and LCM phosphate ores by rejecting impurities to the -325-mesh size fraction (-44 μm), and showing high free apatite at +325 mesh (+44 μm). This indicates that the plant could also operate with the future forecasted phosphate ores.

13.2.4 Wash Plant Beneficiation Product Characterization

Based on the characterization studies of the feed to the Wash Plant and the average of the chemical analyses reported daily during the 2018-2019 period, it is clear that the phosphate rock (beneficiation product) produced from RVM and LCM phosphate ores fulfills the specifications necessary to produce MAP, SPA, and APP. The beneficiation product chemical analysis is presented in Table 13-4.

Table 13-4: Beneficiation Product of the Wash Plant – Chemical Analysis (2018-2019)

H ₂ O, %	13.97
P ₂ O ₅ , %	30.55
CaO, %	43.49
MgO, %	0.52
Al ₂ O ₃ , %	1.60
Fe ₂ O ₃ , %	0.68
SiO ₂ , %	11.68
K ₂ O, %	0.52
Cd, ppm	97
Cr, %	0.05
Cu, ppm	95
Ni, ppm	112
Ti, %	0.06
CaO/P ₂ O ₅ Ratio	1.424
MER	0.092

The beneficiation product results in a 30.55% P₂O₅ washed product with 0.52% MgO, 1.60% Al₂O₃, 0.68% Fe₂O₃, and 11.68% SiO₂ as impurities. The CaO/P₂O₅ Ratio of 1.424 indicates that the presence of carbonates is low for the fluor or hydroxy-apatite. The MER of 0.092 obtained shows that impurities from aluminum silicates, clays, MgO, and iron bearing minerals are below the accepted specification of 0.1. In the case of MgO, the specifications require values lower than 0.60%, which was obtained (0.52% MgO). The SiO₂ analysis shows a decrease of SiO₂ in the product to 11.68% from 19.81% SiO₂ in the feed. Since the beneficiation product particle size was 0.375 inch x 325 mesh (9,525x44 μm), the results show that by scrubbing, crushing, grinding the +0.375-inch material (+9,525 μm), and classifying with a cutting mesh of 325 (44 μm), it is possible to reduce the impurities efficiently in the Wash Plant.

13.2.5 Wash Plant Tailings Characterization

In the case of tailings from the Wash Plant, it is important to minimize the P₂O₅ losses, increase the rejection of impurities, and recover the maximum clarified water from the tailings pond. For these purposes, the plant must be able to reduce the P₂O₅ grade and P₂O₅ content rejected, increase the MER substantially, and maintain a low solids content in the tailings stream with the highest content of -325-mesh material (-44 μm).

Table 13-5 presents the average chemical analysis and physical parameters of the beneficiation tailings from the plant for the years 2018 to 2019. The chemical analysis shows that the P₂O₅ grade is 14.97%, with a high level of impurities, such as 1.08% MgO, 6.62% Al₂O₃, 2.40% Fe₂O₃, and 34.93% SiO₂, as well as other contaminants (Cd, Cu, Cr, Ni, Ti, and so forth). This tailings stream contains on average 85% of -325-mesh material (-44 μm) with a solids content of 11.24%. As expected, the CaO/P₂O₅ Ratio and the MER are reporting high at 1.488 and 0.675, respectively. These ratios are significantly higher than those reported for the feed to the Wash Plant, which are 1.432 and 0.205, respectively. These figures show that the beneficiation of RVM and LCM phosphate ores respond to the process discussed.

Table 13-5: Tailings of the Wash Plant – Chemical Analysis and Physical Parameters (2018-2019)

Solis, %	11.24
-325 mesh, %	84.96
P ₂ O ₅ , %	14.97
CaO, %	22.29
MgO, %	1.08
Al ₂ O ₃ , %	6.62
Fe ₂ O ₃ , %	2.40
SiO ₂ , %	34.93
K ₂ O, %	1.95
Cd, ppm	99
Cr, %	0.19
Cu, ppm	127
Ni, ppm	284
Ti, %	0.23
CaO/P ₂ O ₅ Ratio	1.488
MER	0.675

13.3 Wash Plant Scrubbing Unit Operation

The characterization studies show that the fluor or hydroxy-apatite is the only phosphate mineral present as free and impure apatite. The presence of dolomite (magnesium carbonate) was observed at coarse size fractions (+0.375 inch or +9,525 µm), and tends to report in the -325-mesh size fraction (-44 µm) upon applying scrubbing and size reduction unit operations. These characterization studies show that the impurities are dominated by aluminum silicates, clays, quartz, magnesium, and iron bearing minerals, mainly associated with coarse size fractions (+0.375 inch, or +9,525 µm), and in the -325-mesh size fraction (-44 µm). According with these characterization studies, the phosphate ore will require size reduction unit operations, starting with horizontal scrubbing.

Horizontal scrubbing is a unit operation designed to maximize the contact between particles to clean the surfaces of phosphate mineral particles of slimes, break loose weak inclusions, or attached impurities, and break aggregates of clayish material. In general, scrubbing is considered a simple unit operation in the beneficiation of phosphate ores, which requires the highest solids content to increase particle to particle interactions (impact and rubbing). But it should be noted that scrubbing is a complex operation that should consider the rheology of the system. Consequently, the optimum operating conditions need to be defined, so that a balance between increasing particle to particle interactions and avoiding fines cushion effect is achieved. This cushion effect may occur when slimes, clays, and fines decrease the availability of free water, increasing the apparent viscosity of the phosphate slurry up to that of a paste consistency. Under these conditions, no scrubbing can take place. Therefore, the operating conditions at the scrubbing unit operation are of utmost importance.

The Wash Plant utilizes scrubbing to clean the surfaces of phosphate minerals as well as release impurities under the following operating conditions:

- Capacity: 350 tph
- Feed size: $F_{100} = -8$ inch ($-203,200 \mu\text{m}$)
- Dimensions of horizontal or drum scrubber: 10 ft x 12 ft
- Rotational velocity: 16.2 rpm
- Percentage of the Critical Speed (% C_s): 66.85%
- Estimated operating solids content: 40% to 50%
- Estimated retention time: 1.5 minutes

These conditions seem adequate and contribute to successfully achieving the final specifications of the plant concentrate.

13.4 Sizing and Classification Unit Operations

Sizing and classification unit operations are used to separate the valuable and liberated phosphate mineral from the minerals containing impurities after scrubbing and size reduction unit operations. The characterization studies call for the use of these unit operations to liberate phosphate ore in coarse fractions, to reduce dolomite to a -325-mesh size fraction ($-44 \mu\text{m}$), taking advantage of its softness, and ensure that aluminum silicates, clays, quartz, and iron bearing minerals also report to the -325-mesh size fraction ($-44 \mu\text{m}$). For this, the Wash Plant uses trommels for sizing and hydrocyclones for classification.

Since the scrubbed material requires sizing in order to direct the different coarse size fractions to their corresponding adequate size reduction unit operations, the scrubbed slurry is separated in three size fractions, using a trommel comprising two concentric screens of 0.25 inch ($6,350 \mu\text{m}$) and 1.375 inch ($34,925 \mu\text{m}$). The following size fractions are thus produced:

- -0.25-inch size fraction ($-6,350 \mu\text{m}$), to be directed to the classification stage.
- 1.375 x 0.25-inch size fraction ($34,925 \times 6,350 \mu\text{m}$), to be directed to the rod mill for size reduction.
- +1.375-inch size fraction ($+34,925 \mu\text{m}$), to feed an impact crusher.

Since crushing of the 1.375-inch material ($34,925 \mu\text{m}$) is performed in an open circuit, the crushed material joins the 1.375x0.25-inch size fraction ($34,925 \times 6,350 \mu\text{m}$) and is directed to the rod mill for size reduction.

The second sizing stage corresponds to a trommel screen in the discharge of the rod mill, which completes the size reduction unit operations for the liberation of phosphate mineral without excessive phosphate loss. This trommel comprises two concentric screens of 0.375 inch ($9,525 \mu\text{m}$) and 1-inch openings ($25,400 \mu\text{m}$). The -0.375-inch size fraction ($-9,525 \mu\text{m}$) joins the -0.25-inch material ($-6,350 \mu\text{m}$) from the horizontal scrubber to be

sent to the classification unit operation, whereas the 1x0.375-inch size fraction (25,400x9,525 μm) returns to the rod mill as circulating load, and the +1-inch material (+25,400 μm) is rejected.

The classification of the -0.375-inch (-9,525 μm) phosphate is performed in Krebs gMax-20 Hydrocyclones with a cutting mesh of 325 mesh, or 44 μm . The purpose of this classification unit operation is to separate enriched phosphate ore from the -325-mesh impurities (-44 μm) containing dolomite, quartz, aluminum silicates, clays, and iron bearing minerals, as delineated by the characterization studies and considering the high values of MgO, Al₂O₃, Fe₂O₃ (high MER), and SiO₂ in this size fraction. This -325-mesh size fraction (-44 μm) reports to the overflow of the gMax-20 Hydrocyclones as tailings of the Wash Plant. The 0.375 inch x 325-mesh material (9,525x44 μm) is sent to the dewatering unit operations of the beneficiated product.

The characteristics of the gMax-20 Hydrocyclones are as follows:

- Feed inlet = 35.50 sq.in.
- Feed solids content = 20%
- Feed = 5,956 gpm
- Diameter = 20 inch
- Vortex finder = 8.25 inch
- Apex diameter = 4.50 inch
- Differential pressure = 18 psi
- Overflow solids content = 11.24%
- Overflow -325 mesh = 84.96%
- Overflow yield = 32.11%
- Number of cyclones installed = 5, operating = 3, standby = 2.

Based on the 2018-2019 operating data, the classification system's relative efficiency at the cutting mesh of 325 is 90.23%. The overall efficiency of the classification hydrocyclones is 69.23%.

13.5 Crushing and Grinding Unit Operations

The purpose of these unit operations is to liberate the phosphate mineral from its impurities, which is deemed by the characterization studies to be at the -0.375-inch size fraction (-9,525 μm). Consequently, the coarser fraction of 8 x 1.375 inches (203,200x34,925 μm) will require crushing; whereas, the 1.375 x 0.375-inch size fraction (34,925x9,525 μm) will require grinding in a rod mill to reduce the production of phosphate finer than 325 mesh (-44 μm) that could end in the tailings.

Even though no grindability tests were performed on RVM and LCM phosphate ores, such tests were performed on other phosphate ore deposits possessing similar characteristics, such as the Utah Phosphate Deposit ¹, which resulted in a Bond Crusher Work Index (Bond Low-energy Impact test) of about 9.0 kwh/ton, indicative of a

medium hardness rock. This may be due to the presence of dolomite and quartz in the 8 x 1.375-inch size fraction material (203,200x34,925 μm).

The Bond Rod Mill Work Index is about 9.7 kwh/ton and the Bond Ball Mill Work Index is about 10.4 kwh/ton, and both are considered in the soft range of rock hardness. Due to the phosphate ore enrichment in the 0.375 x 325-mesh (9,525x44 μm) size fraction, this is expected.

The impact crusher used is an efficient size reduction unit, producing a minus 1.375-inch product (-34,925 μm), without producing large amount of phosphate finer than 325-mesh material (-44 μm) to be fed to the rod mill. This unit operation receives 20% of the feed to the Wash Plant (70 tph).

The rod mill used in the Wash Plant is an Allis Chalmers 9 ft x12 ft and uses 4-inch diameter rods as the only rod size loaded to the mill. The operating conditions include the following:

- Volume occupied in the mill = 30% to 35%
- Rotational speed = 16.56 rpm
- Percentage of Critical Speed (% C_s) = 64.80%
- F_{100} = 1.375 inch (34,925 μm)
- P_{80} = 947 μm
- Installed power = 500 HP (373 kw)

Under these conditions, previous studies³ show that the rod mill efficiently grinds the material to minus 0.375 inch (-9,525 μm) with the production of 5.5% to 9.8% of -325-mesh (-44 μm), which is a small fraction of the overall tailings (-325 mesh) totaling 32.11% wt. produced.

The Wash Plant product is ground in two FFE ball mills 11.5 ft x 21.5 ft running in parallel. The purpose of this size reduction is to feed the PAP with a slurry at adequate particle size to allow an acceptable P_2O_5 recovery (98% -35 mesh (-420 μm)). The grinding media used in these mills consists of Cr-Mo steel balls of 2 inches in diameter. The operating conditions include the following:

- Volume occupied in the mill = 40% - 45%
- Rotation speed = 16.9 rpm
- Percentage of the Critical Speed (% C_s) = 74.8%
- F_{80} = 947 μm
- P_{80} = 420 μm
- Power installed per mill = 1700 HP (1260 kw).

After grinding of the Wash Plant product, the slurry is stored in an agitated tank and reclaimed, as needed, by the PAP.

13.6 Dewatering Unit Operations

These unit operations are very important to recycle water to previous described unit operations, namely to the chute of the feed to the scrubber, to the sump of the pump to feed the classification Krebs gMax-20 Hydrocyclones, and to the sump of the pump feeding the dewatering Krebs D15B Hydrocyclones. Dewatering unit operations also allow the Wash Plant product to be handled and fed to the ball mills, so that it is further processed in the PAP.

Dewatering of the enriched beneficiated phosphate ore is carried out in two steps:

- Six dewatering hydrocyclones, Krebs D15B
- Two belt filters (extractors), EIMCO Model 67

The dewatering hydrocyclones Krebs D15B are fitted with a 3-inch diameter apex, and a 6-inch diameter vortex finder. These dewatering hydrocyclones are arranged in two sets of three hydrocyclones, their underflows feeding each of the belt filters, or extractors; however, only five are in operation. The overflow of these dewatering hydrocyclones reports a 4.3% solids content, which is low enough to be recycled to the water distribution system of the Wash Plant.

The belt filters or extractors are EIMCO Model 67 types with one including a blower for drying the cake. The average moisture content of the beneficiated product is 13.97%, as reported in the 2018 to 2019 data (see Table 13-4). With this moisture content, the beneficiation product is stored in a bin and a stockpile for a total of 60,000 tons of storage capacity to feed the ball mills. As shown in Item 13.2.4, the product characterization fulfills the specifications for the PAP.

13.7 Metallurgical Balance

The metallurgical balance for the Wash Plant was obtained using data of the Wash Plant product and Beneficiation Tailings (Bentails) for 2018 and 2019. The Wash Plant feed corresponds to the average weighed analysis of the feed samples for this period; whereas, the Calculated Wash Plant Feed is obtained from the average weighed analysis of both the Wash Plant Product and Bentails. Table 13-6 shows that there exists a small difference on grades reported from the Feed Sample and that of the Calculated Washer Feed, with an average error of 3.47%. This error is considered acceptable for metallurgical standards, and lends confidence to the chemical analyses performed.

The metallurgical balance of the Wash Plant presented in Table 13-6 shows that the yield (weight recovery) of the beneficiation product of the Wash Plant is 67.89%, the Bentails being 32.11% of the yield. These results match with the historical data⁴, and show that RVM and LCM phosphate ores do not present any risk to the MAP, SPA, and APP production and quality. P₂O₅ feed grade is 25.55% with CaO of 36.68%, and impurities analyzed at 0.70% MgO, 3.22% Al₂O₃, 1.23% Fe₂O₃, and 19.14% SiO₂. Thus, the CaO/P₂O₅ Ratio is 1.436 and the MER 0.202. The Wash Plant Product reports at 30.55% P₂O₅, 43.49% CaO, 0.52% MgO, 1.61% Al₂O₃, 0.68% Fe₂O₃, and 11.68% SiO₂, the CaO/P₂O₅ Ratio being 1.424, and the MER being 0.092. These results clearly show that the phosphate ore is enriched to the required specifications. The Bentails reported 14.97% P₂O₅, 22.29% CaO, 1.08% MgO, 6.62% Al₂O₃, 2.40% Fe₂O₃, and 34.93% SiO₂ with a CaO/P₂O₅ Ratio of 1.489 and MER of 0.675. This data shows that impurities are concentrated in the tailings with reasonable losses of P₂O₅.

Table 13-6 shows a P_2O_5 recovery of 81.18% with a rejection of 49.34% MgO, 66.10% Al_2O_3 , 62.71% of Fe_2O_3 , and 58.59% of SiO_2 . The slight CaO rejection (19.51%) may be related to the small amount of calcium carbonates present in the phosphate ore.

Table 13-6: Metallurgical Balance of the Wash Plant (2018-2019)

MATERIAL BALANCE WASH PLANT - 2018-2019														
Product	Wt Tons	Wt %	Grades						Distribution					
			P_2O_5 wt %	MgO wt %	Al_2O_3 wt %	Fe_2O_3 wt %	CaO wt %	SiO_2 wt %	P_2O_5 wt %	MgO wt %	Al_2O_3 wt %	Fe_2O_3 wt %	CaO wt %	SiO_2 wt %
Washer Plant Feed	2993236	100.00	25.49	0.65	3.31	1.27	36.51	19.81	100.00	100.00	100.00	100.00	100.00	100.00
Calculated Washer Plant Feed	2993236	100.00	25.55	0.70	3.22	1.23	36.68	19.14	100.00	100.00	100.00	100.00	100.00	100.00
Washer Plant Product	2032115	67.89	30.55	0.52	1.61	0.68	43.49	11.68	81.18	50.66	33.90	37.29	80.49	42.08
Bentails	961121	32.11	14.97	1.08	6.62	2.40	22.29	34.93	18.82	49.34	66.10	62.71	19.51	58.59

13.8 Summary and Conclusions

In conclusion, to the extent known, there are no processing factors, or deleterious elements, that could have a significant effect on the potential for economic extraction of phosphate rock required by the CPP.

Based on the 2018 to 2019 data, the metallurgical aspects of the Wash Plant operation were analyzed and indicate that the forecast of the projected phosphate rock produced by the Wash Plant would not be significantly affected, and future production of MAP, SPA, and APP uncompromised. This is a consequence of careful preparation of the phosphate ore feed and blending from stockpiles at the CPP, ROM, B+, High MgO, and High Al, which results in a constant -8-inch blended feed (-203,200 μ m) to the Wash Plant.

Characterization studies help the reader understand the Wash Plant operation and demonstrate the feasibility to continue to produce suitable wash plant product for the ensuing years. The characterization studies for the Wash Plant feed (Head) include chemical analysis (see Table 13-1), screen assay (see Table 13-2), and mineralogy (see Table 13-3). These characterization studies indicate that the phosphate mineral is fluor or hydroxy-apatite, and that there is little presence of calcium carbonates. With respect to impurities, the characterization studies indicate that dolomite (magnesium carbonate) seems to be present in the coarse size fractions; whereas, aluminum silicates, clays, iron bearing minerals (as obtained from Al_2O_3 , Fe_2O_3 and SiO_2), and quartz (SiO_2) are concentrated in the -325-size fraction mesh (-44 μ m) with lower phosphate mineral content. At +0.375-inch mesh (+9,525 μ m), phosphate ore is not liberated and contains impurities, such as aluminum silicates, clays, iron bearing minerals, quartz, and dolomite associated with fluor or hydroxy-apatite. However, characterization studies demonstrate that the phosphate mineral is liberated at relatively coarse size fraction, -0.375 inch (-9,525 μ m). This may result in phosphate mineral concentrating in the 0.375 inch x 325-mesh size fractions (9525x44 μ m); whereas, the impurities (dolomite, aluminum silicates, clays, iron bearing minerals, and quartz) are concentrated in the -325-mesh (-44 μ m) size fraction.

The chemical analysis of the Wash Plant Beneficiation Product reports 30.55% P_2O_5 with a CaO/ P_2O_5 Ratio of 1.424 and a MER of 0.092, which clearly shows that a product of the required specifications to feed the PAP is achieved. The MgO grade is 0.52%, with the remaining impurities being 1.6% Al_2O_3 , 0.68% Fe_2O_3 , and 11.68% SiO_2 . The chemical analysis of the Wash Plant tailings shows that most of the impurities associated with phosphate mineral (impure apatite) are concentrated in the minus 325 mesh (-44 μ m). Consequently, low P_2O_5 grade (14.97%) and high MgO (1.08%), Al_2O_3 (6.62%), Fe_2O_3 (2.40%), and SiO_2 (34.93%) are analyzed in the 84.96% -325-mesh material (-44 μ m) going to the tailings.

The characterization results indicate that, to clean the surfaces of phosphate minerals of impurities, it is necessary to first liberate coarse phosphate particles using a horizontal scrubber, processing 350 tph at 40% to

50% solids content, at 66.8% of the Critical Speed (% C_s) and with an estimated residence time of 1.5 minutes. Then, sizing is carried out using a trommel screen sending the +1.375-inch material (+34,925 μm) to an impact crusher, the 1.375 x 0.25-inch size fraction (34,925x6350 μm) to a rod mill, and the -0.25 inch (-6,350 μm) to hydrocyclones. Here, the -325-mesh (-44 μm) material containing impurities is rejected. For this purpose, Krebs gMax-20 Hydrocyclones with a cutting mesh of 325, or 44 μm , are used at 90% efficiency for this cutting mesh, and an overall efficiency for these hydrocyclones of 69%. The same unit operations for sizing and classification are used for the product of the rod mill grinding. Sizing is performed at 0.375 inch (9,525 μm) and 1 inch (25,400 μm) trommel, where the +1 inch (+25,400 μm) is then rejected, the 1 x 0.375 inch (25,400x9525 μm) returns to the grinding mill, and the -0.375 inch (-9,525 μm) is sent to classification. Here, the -0.375 inch (-9,525 μm) joins the minus 0.25-inch material (-6350 μm) from the scrubbing unit operation. Grinding is performed in an Allis Chalmers 9-ft x12-ft rod mill charged with 4-inch diameter rods, at 64.8% of C_s , producing about 5.5% to 9.8% -325-mesh material (-44 μm). The classification overflow of the Krebs gMax-20 Hydrocyclones are the tailings with 11.24% solids content, containing 84.96% -325-mesh material (-44 μm).

Finally, the 0.375 inch x 325-mesh concentrate (9,525x44 μm) is dewatered using Krebs D15B Hydrocyclones and belt filters or extractors. The final moisture content is 13.97% moisture. This Wash Plant concentrate, or beneficiated product, is re-ground to 98% -35 mesh (-420 μm) in two FFE Ball Mills 11.5 ft x21.5 ft and loaded with 2-inch steel balls to be sent and stored as a slurry for the PAP. All these unit operations allow for to reject impurities in the -325-mesh size fraction (-44 μm), and allow for enriched the phosphate ore in the 0.375 inch x 325-mesh size fraction (9,525x44 μm).

Under these conditions, the metallurgical balance shows the yield for the Wash Plant beneficiation product at 67.89%, with tailings at 32.11%. The ore feed to the Wash Plant of 25.55% P_2O_5 results in a beneficiation product, or concentrate, of 30.55% P_2O_5 , and tailings of 14.97% P_2O_5 . The P_2O_5 recovery is 81.18%. These metallurgical balance results are consistent with historical data⁴, and show that RVM and LCM phosphate ores do not present a risk to the MAP, SPA, and APP production and quality, clearly showing that phosphate ore is enriched to the required specifications of 0.52% MgO and a MER of 0.092.

14.0 MINERAL RESOURCE ESTIMATES

This Item contains a discussion of the key assumptions, parameters, and methods used to estimate the Mineral Resources on the Property. The purpose of the discussion is to provide readers with an understanding of the basis for the mineral resource estimate and how it was generated. The mineral resource estimates comply with all disclosure requirements for mineral resources that are set out in NI 43-101. The Item concludes with a general discussion on the extent to which the mineral resource estimates could be materially affected by any known environmental, permitting, legal, title, taxation, socio-economic, marketing, political, or other relevant factors.

14.1 Basis for Mineral Resource Estimate

The basis of the Mineral Resource estimates for the Itafos Conda projects and the PH Project phosphate deposits and the methods in which they were prepared are summarized in this Item. For estimating the Mineral Resources for the Itafos Conda projects and the PH Project, Golder has applied the definitions of “Mineral Resource” as set forth in the Canadian Institute of Mining, Metallurgy and Petroleum Council (CIM) Definitions Standards adopted May 10, 2014 (CIMDS).

Under CIMDS, a Mineral Resource is defined as:

“...a concentration or occurrence of solid material of economic interest in or on the Earth’s crust in such form, grade or quality and quantity that there are reasonable prospects for eventual economic extraction. The location, quantity, grade or quality, continuity and other geological characteristics of a Mineral Resource are known, estimated or interpreted from specific geological evidence and knowledge, including sampling.”

A Mineral Resource can be estimated for material where the geological characteristics and the continuity are known or reasonably assumed and where there is the potential for production at a profit.

Mineral Resources are subdivided into categories of Measured, Indicated, and Inferred, with the level of confidence reducing with each category respectively. Mineral Resources are always reported as in situ tonnage and are not adjusted for mining losses or mining recovery.

The Mineral Resource estimates presented herein were prepared under the supervision of Golder’s QP in accordance with the definitions presented in NI 43-101 and the CIM Definition Standards. The estimates were based on geological and grade block models generated from all verified exploration and pre-production drill holes and analytical samples drilled by the Company to date for the five properties.

Data verification was performed under the supervision of the Golder QP while exploration data collection was performed under the supervision of Company personnel that also met the standard for QPs under the applicable definitions.

The Golder QP used the verified exploration and sample data to construct a computer-based geological block model of the in-situ phosphate deposit and surrounding rocks and a P_2O_5 grade model for each of the five projects. The five individual geological models were based on a structural interpretation of the deposits based on drilling intervals through the deposits and in the case of RVM and LCM, actual geological exposures in the pits. The grade models consisted of estimated grades within each geological block identified as in situ phosphate. The block model grades were interpolated from sample values of drill hole intercepts.

14.2 Key Assumptions, Parameters and Methods Used to Estimate the Mineral Resources

The following sub-Items of this Item provide discussion of the key assumptions, parameters, and methods used to estimate the Mineral Resources in order to provide an understanding of the basis for the estimate and how it was generated.

Geological Interpretation and Controls on Mineralization

The geological domains in the five project models comprise the named beds that are the stratigraphic subdivisions of the Meade Peak Member as well as the overlying and underlying burden units. The beds are the basis of the geological and grade models and are used to identify and control the positions, volumes and interpolated grades of the mineralized material constrained by the roof and floor surfaces of the beds and units. The bed boundaries were modeled as hard boundaries, with sample grades interpolated only within the bed sampled. Overburden and underburden surfaces and intervals were also modeled for stratigraphic continuity as well as to provide unmineralized material volumes and grades for future mine design and scheduling efforts.

The named beds for the Itafos Conda projects models are shown in Table 14-1. The bed sequences are generally the same for all projects as shown in the table although there is some minor variation between projects or within fault blocks of individual models. For the four Itafos Conda projects models, the UPZ and LPZ are broken out into a series of alternating phosphatic and un- to weakly-mineralized units, separated by a Center Interburden (CIB) unit. The steeply dipping to subvertical nature of the beds in the Itafos Conda projects, allows for selective mining of mineralized and unmineralized units using proven open pit mining methods currently used at RVM, LCM, and previously used at past Itafos Conda operations.

The named beds for the PH model are shown in Table 14-2. For the PH Project model, the higher-grade portion of the UPZ and LPZ are targeted to accommodate an underground mining method. Given depth below the surface, the PH beds do not have the potential to be extracted an open pit mining method. The thinner, unmineralized beds cannot be sorted with the underground method.

Table 14-1: Itafos Conda Projects Model Bed Names

Age	Formation	Member	Zone	Bed Name	Description
Quaternary			Overburden	QAL	Quaternary Alluvium
Triassic	Dinwoody			DNW	Dinwoody
Permian	Phosphoria	Rex Chert		CHTSH	Cherty Shale
				RXCHT	Rex Chert
			Upper Phosphate Zone	HWM	Hanging Wall Muds (overburden)
				D1	D1 Bed (high grade)
		D2		D2 Bed (interburden)	
		D3		D3 Bed (high grade)	
		D4		D4 Bed (interburden)	
		UIB		Upper Inter Bed (med grade)	
		D51		D51 Bed (low/med grade)	
		D52		D52 Bed (low/med grade)	
		Center Interburden	CIB	Center Interburden (combined Upper CIB, F Bed and Lower CIB)	
			Lower Phosphate Zone	C	C Bed (low/med-grade)
		FC		False Cap (interburden)	
		UB		Upper B Bed (med/high grade)	
		BP		B Parting (interburden)	
LB	Lower B (med/high grade)				
AC	A Cap (low/med grade)				
A	A Bed (high grade)				
FWM	Foot Wall Muds (underburden)				
Permo-Pennsylvanian	Park City and Wells		Underburden	LST	Undifferentiated Grandure Tongue Limestone and Wells Limestone

Table 14-2: PH Project Model Bed Names

Age	Formation	Member	Zone	Bed Name	Description
Quaternary			Overburden	QA	Quaternary Alluvium
Tertiary	Wasatch			WASH	Wasatch
Triassic	Dinwoody			DIN	Dinwoody
Permian	Phosphoria	Rex Chert Member	Upper Phosphate Zone	REX	Rex Chert
		Meade Peak Member		HWM	Hanging Wall Muds (overburden)
			D	Undifferentiated D Bed (med/high grade)	
			Center Interburden	UCIB	Upper Center Interburden
				CCH	Middle Chert (interburden)
				LCIB	Lower Center Interburden
		Lower Phosphate Zone	A	A Bed (high grade)	
FWM	Foot Wall Muds (underburden)				
Permo-Pennsylvanian	Wells			WELL	Wells Limestone

3D Modeling

Software Selection

Geological modeling and Mineral Resource estimation for the five projects presented in this TR were performed under the supervision of the Golder QP. The geological models for each of the five projects were developed as stratigraphically constrained grade block models using a combination of Sequent Leapfrog Geo™ and Maptek Vulcan modeling software for the Itafos Conda models and Datamine MineScape (v6.1.1) StratModel™ and BlockModel™ for the PH model. All modeling software selected are industry standard computer-assisted geological, grade modeling, and estimation software applications.

Block Model Extents

The four Itafos Conda block models were constructed in the relevant Itafos Conda mine grid coordinate systems while the PH block model was constructed in NAD 1983 Idaho State Plane (Zone 3701) coordinate system. All models were constructed in U.S. customary units and model axes were oriented North-South and East-West.

The model block size parameters were driven by individual deposit geometry and using guidance from existing operations as well as from Golder mining engineers based on early high-level evaluations of mining methods during the QP site visits. The block model spatial extents and block size parameters for each of the five models are presented in Table 14-3.

Table 14-3: Block Model Spatial Extents and Block Size Parameters for Each Model

Project	Direction	Origin (ft)	Extent (ft)	Parent Block Size (ft)	Sub-block Size (ft)
RVM	Easting (X)	3,800	12,520	40	2
	Northing (Y)	7,000	16,000	40	20
	RL (Z)	6,150	1,520	40	5
LCM	Easting (X)	12,600	3,120	40	4
	Northing (Y)	9,300	8,100	20	10
	RL (Z)	5,800	1,320	40	2
NDR	Easting (X)	11,500	2,200	2	2
	Northing (Y)	39,200	10,500	10	10
	RL (Z)	6,200	1,400	40	4
H1	Easting (X)	70,700	7,600	40	2
	Northing (Y)	24,000	24,000	40	20
	RL (Z)	7,000	2,000	40	2
PH	Easting (X)	852,000	9,000	50	12.5
	Northing (Y)	189,300	13,400	50	12.5
	RL (Z)	3,500	3,400	1	0.25

Block Model Parameters

Model parameters for the four Itafos Conda projects block models are summarized in Table 14-4 while the geological and grade parameter fields for the PH block model are summarized in Table 14-5. Default -99 values have been assigned to numerical block parameters as identified in Table 14-4 and Table 14-5.

Table 14-4: Itafos Conda projects Block Model Parameters

Column Number	Parameter	Default Value	Description	Column Number	Parameter	Default Value	Description
1	bed	-	Bed Name	22	al2o3	-99	Al2O3 (%)
2	horizon	-	Horizon Name	23	p2o5	-99	P2O5 (%)
3	fault	-	Fault Block	24	cd	-99	Cd (%)
4	bednum	-99	Bed Number	25	fe2o3	-99	Fe2O3 (%)
5	ston	-99	Short Tons = Volume x Density	26	mgo	-99	MgO (%)
6	thickness	-99	Block Thickness	27	class_txt	-	Res Cat (Measured, Indicated or Inferred)
7	density	-99	Material Density in t/cu.ft (wet)	28	class_int	-99	Res Cat (Mea = 3, Ind = 2, Inf = 1 and Exp = 0)
8	oreclass	-99	Class (1=ROM; 2=HiAl; 3=MGO; 4=BPLUS; 5=PLUS2)	29	pnum	-99	Estimation Pass Number
9	orename	-	Product class name	30	kslope	-99	P2O5 Slope of Regression from estimation
10	bench	-99	Design Parameter - Bench width	31	kvar	-99	P2O5 Kriging Variance from estimation
11	bheight	-99	Design Parameter - Bench height	32	keff	-99	P2O5 Kriging Efficiency from estimation
12	bedding	-99	Design Parameter - Bedding angle	33	npass	-99	Number of estimation passes
13	bfa	-99	Design Parameter - Bench Face angle	34	lstslope	-99	Imported Slope Angle from model LST surface
14	ira	-99	Design Parameter - Inter-ramp angle	35	orezone	-	Upper (UO) or Lower (LO) ore zone
15	material	-	Ore or Waste	36	faultzone	0	Flag for classification downgrade 1 = downgraded
16	material number	-99	Ore or Waste Number	37	distance	-99	Weighted Average Distance estimation samples
17	loi	-99	LOI (%)	38	nholes	-99	Number of holes used in estimation

Note:

Bold parameters were used in the resource estimation process while other parameters were included for mine design and other purposes.

Table 14-5: PH Block Model Parameters

Column Number	Parameter	Default Value	Description	Column Number	Parameter	Default Value	Description
1	IJKNUM	-	IJK (xyz) cell identifier	15	MGO	-99	MGO (wt%) by ID2
2	XCEN	-	Block centroid easting	16	NA2O	-99	NA2O (wt%) by ID2
3	XCEN	-	Block centroid northing	17	OREZONE1	-99	Measured Category Code
4	XCEN	-	Block centroid elevation	18	OREZONE2	-99	Indicated Category Code
5	ILEN	-	Block dimension, east-west	19	OREZONE3	-99	Inferred Category Code
6	JLEN	-	Block dimension, north-south	20	ORGC	-99	ORGC (wt%) by ID2
7	KLEN	-	Block dimension vertical	21	P2O5	-99	P2O5 (wt%) by ID2
8	DENSITY	2.6	Dry bulk density (default 2.6g/cm3)	22	P2O5_CNTR	-99	Number of samples used in estimation
9	AL2O3	-99	AL2O3 (wt%) by ID2	23	P2O5_ID3	-99	P2O5 (wt%) by ID3
10	CAO	-99	CAO (wt%) by ID2	24	P2O5_NN	-99	P2O5 (wt%) by NN
11	ACIDINSOL	-99	ACIDINSOL	25	SEARCH_P	-99	Number of estimation passes
12	FE2O3	-99	FE2O3 (wt%) by ID2	26	CAP	-99	Calculated CAO:P2O5 ratio
13	INTERVAL	-	Geological Bed/Unit name	27	MER	-99	Calculated Minor Element ratio
14	K2O	-99	K2O (wt%) by ID2				

Note:

Bold parameters were used in the resource estimation process while other parameters were included for mine design and other purposes.

Density Determination and Moisture Basis

The QP used an average density value to estimate tons for each block in the geological model for each of the 5 projects. An average density of 0.074 short tons per cubic foot (st/ft³), wet basis, later converted to dry basis using a default moisture content of 10% was applied to mineralized intervals for the Itafos Conda projects while an average density of 0.081 st/ft³, dry basis was applied for the PH Project.

The average density value applied to the Itafos Conda projects was based on density analyses from 25 samples collected from RVM and LCM and reflect current resource estimation practices at the mines and reconciliations of mined volumes and scaled tons. The average density value applied to the PH Project was based on density analyses from 211 samples collected during PHA exploration campaigns.

The Itafos Conda projects density analyses were performed using the water displacement method for density determination, with values reported on a wet basis, while the PH Project density analyses were performed using the water displacement method and were reported on a wet and dry basis.

Density values were assigned for all geological units in the models, including mineralized units as well as overburden, interburden, and underburden unmineralized units.

The Itafos Conda projects' geological models were developed using wet density data and dry basis grade data. Final wet tons were converted to dry basis based on a default 10% moisture content and the resultant estimated Mineral Resource tonnages are presented on a dry basis. The moisture content of 10% has been assumed based on typical moisture contents observed from Itafos Conda grade control sampling.

The PH Project geological model was developed using dry basis density and grade data and as a result no moisture conversions were applied. Based on density and moisture analysis performed by independent analytical laboratories as part of previous metallurgical studies for the PH Project, the moisture content for the PH beds is determined to be low, with a mean moisture content of 1.5%, ranging from 0% to 10% from 104 moisture analyses.

While the chosen default density and moisture parameters are deemed to be sufficient for the calculation of mass from volume and for the conversion of Mineral Resources from wet to dry basis, it is recommended that additional samples should be collected and density and moisture analyses evaluated as part of future analytical programs for the NDR, H1 and PH projects.

Estimation Techniques

Golder performed grade estimation into the block models for each project using Vulcan for the Itafos Conda projects models and MineScope for the PH Project model. Grade data was interpolated into the block models using verified samples. Grade estimates were completed using Ordinary Kriging (OK) for the Itafos Conda projects and using Inverse Distance Squared (ID²) for the PH Project.

Grade interpolation in the five block models was based on the key assumption that grade is spatially dependent and not random. Golder completed a semi-variogram analysis (variography) for each project for key grade variables in each of the five composited datasets. The variogram parameters were used for grade estimation and the ranges of the variograms to assist with the definition of resource categorization parameters.

The geological bed surfaces from the stratigraphic model were used to constrain the assignment of the geological unit to the model blocks based on the spatial relationship of the block relative to the unit roof and floor surfaces.

Grade values were interpolated within the geological units using only samples intersected within those units; sub-celling was applied to allow for improved definition of geological contacts relative to the model blocks at the upper and lower contacts of the units.

Given the stratigraphic nature of the deposits and the fact that the faulting post-dates deposition of the mineralized beds, grade values were allowed to interpolate across fault block boundaries but were restricted to interpolate only within the beds, controlled by the bed names assigned to the model blocks from the stratigraphic model. The search parameters were applied across the entirety of each of the five block models; there were no different search parameters applied based on geological, structural, or other domains.

Model Review and Validation

Golder performed internal reviews and validations of the five geological models using a combination of visual inspection and statistical analysis checks between drill hole data and modeled surfaces, thicknesses, and grades. The Itafos Conda geology and mining engineering team was also directly involved in the iterative model review process, providing feedback and guidance on numerous iterations of the geological models.

Visual inspection included review of regularly spaced sections through the model along with plan isopleth maps of key structure (roof and floor surfaces and bed thicknesses) and grade models. Drill hole and model values were also compared statistically using summary statistics of the drill hole data against the model values. The models were also sampled at individual drill hole locations to confirm that model values were representative of the drill hole values.

The visual and statistical inspections of the five geological models found that the models were a reasonable representation of the geological data available and that they are considered a reliable representation of the structure and grade for the phosphate bearing beds of interest in each of the five deposits.

As RVM and LCM are both currently in production, Golder performed reconciliation evaluations for small areas within both pits using production data and surfaces provided by Itafos Conda mining engineering personnel; however, the reconciliations for both deposits returned differences between the updated models and the production results. Upon review, the reconciliation results were inconclusive, and Golder did not make any changes to the model based on the results of the reconciliation due to concerns over representativeness of the areas evaluated. It is recommended that the models continue to be evaluated against mine mapping and grade control data and that reconciliation calculations be performed regularly to evaluate the models against actuals.

Reconciliation evaluations were not performed for the NDR, H1, and PH projects as all three are advanced exploration projects and have not had any current or historical production activity.

14.3 Mineral Resource Estimation

Limits and Constraints on the Mineral Resource Estimates

The Mineral Resources presented in this Item have been estimated by applying a series of physical and geological limits as well as high-level mining and economic constraints; the mining and economic constraints were limited only to a level sufficient to support reasonable prospects for future economic extraction of the estimated resources. A summary is as follows of the of the key constraints on the Mineral Resource estimates by type:

- Physical Limits:
 - Lease boundaries.
 - Topography.
 - Existing roads, utilities, ex-pit dumps, and other surface infrastructure in place at the current mining operations at RVM and LCM as directed by Itafos Conda.
- Geological Limits:
 - Base of alluvium.
 - Modeled roof and floor contacts of the individual beds.
 - Water table.
- Mining and Economic Constraints:
 - Resource categorization parameters based on distance from point of observation and drill hole sample count criteria.
 - Reasonable basic mining parameters and cost assumptions were applied to develop resource pit shells for the Itafos Conda projects and to evaluate potential underground mining at PH for the purpose of establishing reasonable prospects for future economic extraction. No formal mine design or economic analyses were performed as part of the resource evaluation process.
 - A 20% minimum P₂O₅ grade for the 4 Itafos Conda projects and the UPZ mineralization at the PH Project, based on current CPP specifications.
 - A 24% minimum P₂O₅ grade for the LPZ at the PH Project to allow for a head-grade of 30% P₂O₅, which is amenable to direct-shipping without the need for beneficiation.

Reasonable Prospects for Economic Extraction

The Mineral Resource estimates for the potentially surface mineable resources (RVM, LCM, NDR, and H1) were constrained by conceptual resource pit shells for the purpose of establishing reasonable prospects of eventual economic extraction based on potential mining, metallurgical, and processing grade parameters identified by mining, metallurgical, and processing studies performed to date on the Project.

The Mineral Resource estimates for the potentially underground mineable resources at PH were constrained by property boundaries on north, south, and east sides. A vertical limb on the west side of the property would require

an alternative mining method and to date has not been drilled to the extent to support an estimate of geologic resources.

Key constraint inputs included reasonable assumptions for P₂O₅ value, operating costs, and a 20% minimum P₂O₅ grade for the four Itafos Conda projects and the UPZ mineralization at the PH Project, based on current CPP specifications; these constraints and assumptions were applied for all estimated resources except for the LPZ mineralization at PH. The LPZ at PH was defined using a 24% minimum P₂O₅ grade to allow for a head-grade of 30% P₂O₅, which is amenable to direct-shipping without the need for beneficiation.

Because Itafos Conda is a vertically integrated fertilizer business and there is no open market for mined phosphate ore in southeastern Idaho, for the purpose of assessing reasonable prospects of economic extraction, P₂O₅ value was defined as the Gross Margin Available per Ton of P₂O₅ loaded FOB WV Tipple (GMA). The GMA is the amount of funds remaining after all estimated cash costs related to the CPP and rail transport from the mines to the CPP are deducted from forecast revenues from the sale of fertilizer products, see Item 19 for additional information on fertilizer product prices and estimated GMAs.

Further details of the Mineral Resource justification for the Itafos Conda projects and the PH Project are as follows.

Itafos Conda Projects Resource Pit Shells

Golder utilized Vulcan Pit Optimizer software to develop the resource pit shells for the Itafos Conda projects' models. Vulcan Pit Optimizer uses the Lerchs Grossman (LG) algorithm along with user-defined input parameters and constraints to assign a value to each block within a block model to produce pit shells for a range of user-defined economic limits. The economic limits were based on the GMA estimated for the projects.

Given that RVM and LCM were both actively producing mines, surface constraints such as existing roads, utilities, infrastructure, and other mine related structures were applied along with the lease boundaries as limits to the resource shells. Golder used the GMA per Ton of P₂O₅ Required as a guide for delineating the extent of resources. The GMA per Ton of P₂O₅ Required is defined in Item 19 and estimated as \$269/ton of P₂O₅ contained in the feed as delivered free-on-board (FOB) at the loadout point. Costs to the WV Tipple are provided in Table 14-6.

Table 14-6: Itafos Conda Projects Resource Pit Shell Cost Parameters

Parameter	Unit	RVM	LCM	NDR	H1
Waste Mining Cost	\$/st (wet)	3.83	4.56	3.83	3.83
Ore Mining Cost	\$/st (wet)	7.28	9.16	7.28	7.28
Royalty (@ 25%P2O5)	\$/st (wet)	1.69	1.69	1.69	1.69
Stockpile & Loadout Costs	\$/st (wet)	1.32	1.32	1.32	1.32
Mining Recovery	%	100	100	100	100
Mining Dilution	%	0	0	0	0

Note:

\$/st (wet) = US dollars per short ton (wet basis).

Based on an analysis of the resource shell options with senior mining and geology personnel, Golder selected the resource pit shells with the following GMA for the purposes of delineating Resources:

- RVM: \$325 / dry ton of P₂O₅ in feed free on board (FOB) WV Tipple
- LCM: \$325 / dry ton of P₂O₅ in feed FOB WV Tipple
- NDR: \$380 / dry ton of P₂O₅ in feed FOB WV Tipple
- H1: \$380/ dry ton of P₂O₅ in feed FOB WV Tipple

The \$325 GMA for RVM and LCM reflect the fact that they will be mined out in a relatively short time period and therefore there is limited time for changes in processing technology and potential increases in phosphate processes. The \$380 GMA for NDR and H1 reflect the substantial increase in phosphates price in terms of constant 2019 dollars provided by CRU, see Item 19 for the CRU forecasts of fertilizer product prices.

PH Project Resource Constraints

The PH Project has been previously studied including resource evaluation and cost estimation. Substantial changes in the requirements for groundwater pumping have resulted in a reevaluation of the PH resource estimate.

Golder reviewed an internal cost model prepared by Itafos and found the cost to deliver PH feed to the Conda facility to be approximately \$90/ton (including capex but exclusive of dewatering cost) to be adequate for use in the development of a resource estimate. A high-level cost estimate for dewatering at a revised peak rate of 35,000 gpm returned estimated capital and operating costs at approximately \$340 M. Golder applied 80% of this dewatering cost to the lower 9.2 Mt of ore in the lower half of the LPZ Mineral Resource as an approximate allocation based on increased pumping cost at depth. This allocated dewatering costs at about \$7.5/t for the upper half of LPZ and \$30/t for the lower half of LPZ with total cost of \$97.5/t for the upper and \$120/t for the lower half of the LPZ. The cost of \$120/t at a grade of 30% P₂O₅ equates to \$400/ton of contained P₂O₅ in the LPZ feed.

At a grade of 30% the LPZ does not require beneficiation. Beneficiation results in an estimated 19% loss of P₂O₅ and has a cost of \$6.77/t of beneficiated rock. Table 14-7 estimates the breakeven value of the LPZ contained P₂O₅ at \$414/t delivered to the Conda facility which is marginal with an estimated cost of \$396/t. CRU has predicted an increase in phosphate prices which is reflected in the increased Product Revenue from \$307 M in 2019 to \$372 M in 2025 (see Item 19 for more information on Market Studies). The increased revenue raises the breakeven value of the LPZ feed to \$541/ton of P₂O₅, which meets the requirement for reasonable prospect for economic extraction.

Golder performed a similar evaluation on the UPZ mineralization for the PH Project. Assumptions made regarding the UPZ were as follows:

- Mining cost would be reduced by 20% to account for efficiencies related to a thicker phosphate bed.
- Only an incremental dewatering cost of \$2/t dry was applied to the UZ.
- Non dewatering capex equal to the LZ rate.

Table 14-7: Paris Hills (PH) Resource Constraint Cost Parameters

Item	Units	2019	2025
Gross Margin Available per Ton of Beneficiated P₂O₅	\$/dry st	414	541
Total Cost of Delivered P ₂ O ₅ Upper LPZ Zone	\$/dry st	262	
Total Cost of Delivered P ₂ O ₅ Lower LPZ Zone	\$/dry st	396	
Total Cost of Delivered & Beneficiated P ₂ O ₅ Upper Zone	\$/dry st	454	
Gross Margin Available per Ton of Contained P₂O₅	\$/dry st	294	399
Total Cost of Delivered P ₂ O ₅ Upper Zone	\$/dry st	347	

Based on these assumptions the total delivered cost of the UPZ feed was \$78/st dry. At a mean P₂O₅ grade of 22.5%, the cost to deliver to the CPP is approximately \$350/st of dry P₂O₅. Based on 2025 CRU price forecast and the Gross Margin Available for P₂O₅ contained in feed of \$399, the UPZ meets the requirement for reasonable prospect for economic extraction.

Mineral Resource Classification and Categorization

Mineral Resource classification and categorization assigned to the Mineral Resource estimates as presented in this TR were in accordance with NI 43-101, which provides for the classification of a mineral deposit into Mineral Resources and/or Mineral Reserves. Under the NI 43-101 definitions, Mineral Resources should be estimated and categorized under Measured, Indicated and/or Inferred categories, as applicable given the confidence of the estimator in the basis of the estimates. NI 43-101 requires the disclosure of these categories of Mineral Resources in technical reports.

The Mineral Resource categorization applied by Golder has included the consideration of data reliability, spatial distribution, abundance of data, continuity of geology, and grade parameters. Golder performed a statistical and geostatistical analysis for evaluating the confidence of continuity of the geological units and grade parameters. The results of this analysis were applied to developing the Mineral Resource categorization criteria.

Mineral Resources categorization criteria for each of the five projects are summarized in Table 14-8. The distance from drill hole component of the categorization criteria were based on variogram range distances for P₂O₅ grade from each of the five projects.

Table 14-8: Mineral Resource Categorization Criteria by Project

Project	Resource Category	Classification Criteria	
		Distance from Drill Hole	Minimum Number of Holes
RVM	Measured	≤ 150 ft	N/A*
	Indicated	> 150 ft and ≤ 300 ft	N/A*
	Inferred	> 300 ft and ≤ 600 ft	N/A*
LCM	Measured	≤ 375 ft	3 or more
	Indicated	> 375 ft and ≤ 750 ft	3 or more
		≤ 375 ft	2 or less
	Inferred	> 750 ft and ≤ 1500 ft	3 or more
> 375 ft and ≤ 750 ft		2 or less	
NDR	Measured	≤ 250 ft	3 or more
	Indicated	> 250 ft and ≤ 500 ft	3 or more
		≤ 250 ft	2 or less
	Inferred	> 500 ft and ≤ 750 ft	3 or more
> 250 ft and ≤ 500 ft		2 or less	
H1	Measured	≤ 500 ft	3 or more
	Indicated	> 500 ft and ≤ 1000 ft	3 or more
		≤ 500 ft	2 or less
	Inferred	> 1000 ft and ≤ 2000 ft	3 or more
> 500 ft and ≤ 1000 ft		2 or less	
PH	Measured	≤ 650 ft	3 or more
	Indicated	> 650 ft and ≤ 1,300 ft	3 or more
	Inferred	> 1,300 ft and ≤ 2,600 ft	3 or more

Note:

*Sample/drill hole restrictions were not applied for RVM as there was abundant well-spaced drilling and sampling.

The volumes, tons, and grades for the categorized Mineral Resource estimates were then tabulated by mineralized beds for each of the five projects. The estimates and their summary tabulations were reviewed by the Golder QP prior to stating the Mineral Resources as presented in Item 14 of this TR.

It is the Golder QP's view that the classification criteria applied to the Mineral Resource estimate are appropriate for the reliability and spatial distribution of the base data and reflect the confidence of continuity of the modeled geology and grade parameters.

Mineral Resource Statement

The categorized estimated Mineral Resources for RVM, LCM, NDR, H1, and PH are presented in Table 14-9. Mineral Resource categorization of Measured, Indicated, and Inferred Mineral Resources presented in Table 14-9 is in accordance with the CIM definition standards (CIMDS, 2014). The Effective Date of the Mineral Resource Estimate is July 1, 2019.

Although the Mineral Resources presented in this TR are believed to have a reasonable expectation of being extracted economically, they are not Mineral Reserves. Estimation of Mineral Reserves requires the application of modifying factors and a minimum of a PFS. The modifying factors include, but are not restricted to, mining, processing, metallurgical, infrastructure, economic, marketing, legal, environmental, social, and governmental

factors. To date, except as described in Item 15 of this TR, studies that provide further insight into prospects for development and extraction of the Mineral Resources have not been completed to a minimum of a PFS.

With respect to RVM and LCM, for which Mineral Reserves are reported in Item 16 of this TR, the Mineral Resources are inclusive of Mineral Reserves.

The Mineral Resources presented in this TR for H1 and NDR for which a PEA is presented in Item 24.0 of this TR, are not Mineral Reserves and do not reflect demonstrated economic viability.

For all projects, the reported Inferred Mineral Resources are considered too speculative geologically to have the economic considerations applied to them that would enable them to be categorized as Mineral Reserves.

There is no certainty that all or any part of this Mineral Resource will be converted into Mineral Reserve.

Table 14-9: Summary of Estimated Mineral Resources – Effective Date July 1, 2019

Project	Zone	Resource Classification	Volume (millions; bcf)	Short Tons (Millions, dry)	P ₂ O ₅ (wt.%)	MgO (wt.%)	Fe ₂ O ₃ (wt.%)	Al ₂ O ₃ (wt.%)
RVM	UPZ & LPZ Combined	Measured	197.5	13.0	26.6	0.90	0.86	2.33
		Indicated	27.0	2.0	26.2	0.63	0.90	2.46
		Inferred	2.5	0.2	25.7	0.59	0.92	2.48
LCM	UPZ & LPZ Combined	Measured	14.0	1.0	27.5	0.90	0.80	1.34
		Indicated	6.5	0.5	28.2	0.98	0.76	1.62
		Inferred	0.5	0.0	27.5	1.15	0.66	1.56
NDR	UPZ & LPZ Combined	Measured	95.0	6.5	26.9	0.82	-	2.38
		Indicated	19.0	1.5	27.0	0.91	-	2.32
		Inferred	2.0	0.1	26.8	0.94	-	2.39
H1	UPZ & LPZ Combined	Measured	314.5	21.0	24.3	0.98	0.82	2.09
		Indicated	128.0	8.5	24.7	0.98	0.84	2.13
		Inferred	10.5	0.5	24.3	0.89	0.82	2.04
PH	UPZ	Measured	320.5	26.0	22.9	0.89	0.80	1.15
		Indicated	492.0	40.0	22.3	0.86	0.81	1.06
		Inferred	93.0	7.5	22.0	0.89	0.75	0.99
	LPZ	Measured	157.5	13.0	30.9	0.26	0.51	1.02
		Indicated	223.5	18.0	29.5	0.59	0.49	0.81
		Inferred	49.0	4.0	30.1	0.63	0.46	0.77
Totals	UPZ & LPZ Combined	Measured	1,099.0	80.5	25.5	0.81	0.70	1.67
		Indicated	896.0	70.5	24.6	0.80	0.72	1.19
		Inferred	157.5	12.3	24.8	0.80	0.65	1.00

Notes:

- RVM = Rasmussen Valley Mine; LCM = Lanes Creek Mine; NDR = North Dry Ridge Project; H1 = Husky 1 Project; PH = Paris Hills Project; UPZ = Upper Phosphate Zone; LPZ = Lower Phosphate Zone; bcf = bank cubic feet; wt.% = weight percent.
- Mineral Resource categorization of Measured, Indicated and Inferred Mineral Resources presented in the summary table is in accordance with the CIM definition standards (CIMDS, 2014).
- The Mineral Resources presented are reported on a dry in-situ basis. Masses for the four Itafos Conda projects have been converted from wet to dry basis using a 10% moisture factor. The PH Project masses were estimated in dry basis.
- No recovery, dilution or other similar mining parameters have been applied.
- Although the Mineral Resources presented in this TR are believed to have a reasonable expectation of being extracted economically, they are not Mineral Reserves. Estimation of Mineral Reserves requires the application of modifying factors and a minimum of a PFS. The modifying factors include, but are not restricted to, mining, processing, metallurgical, infrastructure, economic, marketing, legal, environmental, social, and governmental factors. To date, except as described in Item 15 of this report, studies that provide further insight into prospects for development and extraction of the Mineral Resources have not been completed to a minimum of a PFS.
- With respect to RVM and LCM, for which Mineral Reserves are reported in Item 16 of this TR, the Mineral Resources are inclusive of Mineral Reserves.
- The Mineral Resources presented in this TR for H1 and NDR for which a PEA is presented in Item 24 of this TR, are not Mineral Reserves and do not reflect demonstrated economic viability.
- For all projects, the reported Inferred Mineral Resources are considered too speculative geologically to have the economic considerations applied to them that would enable them to be categorized as Mineral Reserves.
- There is no certainty that all or any part of this Mineral Resource will be converted into Mineral Reserve.
- Mineral Resource estimates are not precise calculations, being dependent on the interpretation of limited information on the location, shape and continuity of the occurrence and on the available sampling results. All figures are rounded to reflect the relative accuracy of the estimates.
- The Mineral Resource estimates for the potentially surface mineable resources (RVM, LCM, NDR, and H1) were constrained by conceptual pit shells for the purpose of establishing reasonable prospects of eventual economic extraction based on potential mining, metallurgical and processing grade parameters identified by studies performed to date on the Project.
- The Mineral Resource estimates for the potentially underground mineable resources at PH were constrained by property boundaries on north, south and east sides as well as depth, water and high-level economic considerations. A vertical limb on the west side of the property would require an alternative mining method and to date has not been drilled to the extent to support an estimate of geologic resources.
- Key constraint inputs included reasonable assumptions for operating costs, CRU fertilizer product forecast prices and a 20% minimum P₂O₅ grade for the four Itafos Conda projects and the UPZ mineralization at the PH Project, based on current CPP specifications for all estimated resources except for the LPZ mineralization at PH. The LPZ at PH was defined using a 24% minimum P₂O₅ grade to allow for a head-grade of 30% P₂O₅, which is amenable to direct-shipping without the need for beneficiation.

Based on the geological results presented in this TR, supported by the active mining operations at Conda, mine design, and modifying factors studies currently underway for the various projects, it is the Golder QP's opinion that the Mineral Resources have reasonable prospects for eventual economic extraction based on the criteria presented in Item 14 of this TR.

Potential Impacts to Mineral Resource Estimates

This Item is a general discussion on the extent to which the Mineral Resource estimates could be materially affected by any known environmental, permitting, legal, title, taxation, socio-economic, marketing, political, or other relevant factors.

The Mineral Resource estimates presented in this TR are based on the factors related to the geological and grade models and the criteria for reasonable prospects of eventual economic extraction presented in this TR. The Mineral Resource estimates may be affected positively or negatively by additional exploration that expands the geological database and models of mineralized zones for the individual project areas. The Mineral Resource estimates could also be materially affected by any significant changes in the assumptions regarding forecast prices, costs, or other economic factors that were used in the resource pit shell development process for the Itafos Conda projects and the evaluation of underground resources for the PH Project. If the price assumptions are decreased or the assumed costs increased significantly, then the minimum P₂O₅ grade must be increased and, if so, the potential impacts on the Mineral Resource estimates would likely be material and need to be re-evaluated.

The Mineral Resource estimates for NDR, H1, and PH are also based on assumptions that a mining project may be developed, permitted, constructed, and operated at each of these individual advanced exploration properties. Any material changes in these assumptions would materially and adversely affect the Mineral Resource estimates for these projects; potentially reducing to zero. Examples of such material changes include the failure to obtain permits for H1, NDR or PH, failure to obtain off-project backfill dumping consents, unexpected substantial decline in western North American fertilizer market demand and prices, extraordinary time required to complete or perform any required activities, or unexpected and excessive taxation or regulation of mining activities that become applicable to any proposed mining projects. Except as described in this report, the Golder QP does not know of environmental, permitting, legal, title, taxation, socio-economic, marketing, political, or other relevant factors that could materially affect the Mineral Resource estimates.

15.0 MINERAL RESERVE ESTIMATES

This Item discloses Mineral Reserve estimates for the RVM and the LCM and summarizes the methods used by the QP and the extent to which the estimates could be materially affected mining, metallurgical, infrastructure, permitting, and other relevant factors. The estimated Mineral Reserves are in accordance with the definitions of “Mineral Reserve” as set forth in the CIMDS adopted May 10, 2014 (CIMDS). Under CIMDS, a Mineral Reserve is defined as:

“...is the economically mineable part of a Measured and/or Indicated Mineral Resource. It includes diluting materials and allowances for losses, which may occur when the material is mined or extracted and is defined by studies at Pre-Feasibility or Feasibility level as appropriate that include application of Modifying Factors. Such studies demonstrate that, at the time of reporting, extraction could reasonably be justified.

The reference point at which Mineral Reserves are defined, usually the point where the ore is delivered to the processing plant, must be stated. It is important that, in all situations where the reference point is different, such as for a saleable product, a clarifying statement is included to ensure that the reader is fully informed as to what is being reported.

The public disclosure of a Mineral Reserve must be demonstrated by a Pre-Feasibility Study or Feasibility Study.”

CIM defines Modifying Factors as “considerations used to convert Mineral Resources into Mineral Reserves. These include, but are not restricted to, mining, processing, metallurgical, infrastructure, economic, marketing, legal, environmental, social and governmental factors.” Modifying Factors used to convert Mineral Resources to Mineral Reserves for RVM and LCM were described previously in this Item.

Mineral Reserves are subdivided into classes of Probable Mineral Reserves and Proven Mineral Reserves, which correspond to Indicated and Measured Mineral Resource, respectively, with the level of confidence reducing with each class. The Canadian Institute of Mining and Metallurgy and Petroleum (CIM) has defined Mineral Reserves in *The CIM Definition Standards for Mineral Resources and Reserves* (2014) as:

- 1) **Probable Mineral Reserve:** the economically mineable part of an Indicated, and in some circumstances, a Measured Mineral Resource. The confidence in the Modifying Factors applying to a Probable Mineral Reserve is lower than that applying to a Proven Mineral Reserve.
- 2) **Proven Mineral Reserve:** the economically mineable part of a Measured Mineral Resource. A Proven Mineral Reserve implies a high degree of confidence in the Modifying Factors.

Key Assumptions, Parameters, and Methods

The following key assumptions, parameters, and methods describe how the QP converted the mineral resources to mineral reserves. Open pit mining methods are used at the RVM and the LCM and are planned to continue until the phosphate reserve is depleted within the planned pit boundaries. To estimate Mineral Reserves, a pre-feasibility study (PFS) was prepared under the supervision of the QP including open pit mine designs and mining plans for the RVM and the LCM. The mining plans included annual stripping and ore production quantities. Annual production costs were estimated based on the mine plan quantities, open pit mining methods, equipment fleets in use, and unit prices stated in the current mining contract. The mining plans and cost estimates were developed to a PFS level of detail. The open pit mine designs, mining plans, and production schedules are summarized in Item

16 of this report. The annual production and capital cost estimates are summarized in Item 21, and an economic analysis of the mining and production plan is summarized in Item 22.

The economic limits of the RVM and LCM open pits were determined using Vulcan Pit Optimizer software applied to the RVM and LCM geological block models described in Item 14. The Vulcan Pit Optimizer software uses the industry-standard Lerch Grossman algorithm to assign an economic value to each block based on user-defined unit costs and other relevant input parameters and constraints such as dilution and mining recovery assumptions for mineral resource blocks. For a given revenue or in this case GMA assumption, the pit optimization process produces a pit shell that includes all economic mineral resource blocks within the limits of the pit shell. Economic mineral resource blocks are those blocks with a positive value at the assumed revenue parameters.

The RVM and the LCM supply phosphate ore exclusively to the CPP, and there is no open market price in SE ID for the ore. The CPP pays all costs of production including royalties and costs to stockpile and load UPRR rail cars for transport to the CPP. To determine an economic mining limit under these circumstances, a Gross Margin Available per dry ton of P₂O₅ was estimated FOB Rail car at the WV Tipple (GMA). The GMA was estimated to be the prices of the fertilizer products to be produced and sold by the CPP minus all costs of manufacturing the fertilizers, handling and washing the phosphate ores received at the CPP, and rail freight costs for delivering the mined phosphate ores. The GMA then is the maximum cash price that the CPP could pay for mined phosphate ore FOB Rail car at the WV Tipple to breakeven on the transaction. See Item 19 for additional details on the estimated GMAs for mined phosphate ore from the RVM and the LCM.

Modifying factors used to determine geological model block values in the RVM and LCM pit optimizations are shown in Table 15-1. The non-revenue factor of mining recovery was not applied to the pit optimizations. However, based on historical data from Itafos Conda, a 97% mining recovery was applied during the mine scheduling process. The estimated unit costs for LCM are significantly higher than the RVM due to the smaller class of mining equipment utilized, the longer haul distances, and re-handle required to transport ore from LCM to the WV Tipple stockpile.

Table 15-1: Modifying Factors for Determining Geological Model Block Values (As of July 1, 2019)

Modifying Factor	Unit	RVM Values	LCM Values
Rock Mining Cost	\$/st (wet)	3.83	4.56
Ore Mining Cost	\$/st (wet)	7.27	11.34
Shipping Cost ¹	\$/st (wet)	1.32	1.32
Royalty Cost ²	\$/st (wet)	1.7	Incl. in Ore Mining Cost
Gross Margin Available per P ₂ O ₅ ton FOB WV Tipple	\$/st (dry) P ₂ O ₅	271	271
Mining Recovery	%	100	100
Mining Dilution	%	0	0

Notes: 1. Includes the cost to re-handle the ore from the stockpile into the tipple (rail loadout facility).

2. Royalty cost varies with grade and averages \$1.70/st (wet).

Additional constraints applied during the pit optimization processes were as follows for each project.

At the RVM and the LCM:

- Mineral resource blocks classified as Measured or Indicated and with P₂O₅ grades equal to or greater than 20% were assumed to be potential mill feed. All other material was designated as overburden or interburden rock.
- The water table was assumed to be at an elevation of 6,345 feet AMSL, and all pit shells were constrained to blocks above that elevation.

At the RVM only:

- The existing RVM access road located on the west side of the RVM pit and continuing to the LCM pit was considered a constraint.
- The southeast pit limit at the 8,000-foot northing (mine grid), which is the approximate boundary of a portion of the Idaho State Wildlife Management Area (WMA) was used to constrain the pit shells.

At the LCM only:

- The southern pit extent was limited due to an existing OSA.
- The northern pit extent was limited by the property boundary.
- The water table at an elevation of 6,345 feet was considered the lowest mineable elevation for RVM.
- P₂O₅ grade must be greater or equal to 20% to be considered as ore.

Using the pit optimization processes, economic pit shells were defined for the RVM and the LCM. The pit shells were then used to limit simulated mining sequences planned within each pit shell. Prior to sequencing, Golder applied a mining loss of 3% to the designated Mineral Resource blocks within the pit shell based on the following discussion.

For the RVM and LCM, Golder reviewed the Itafos Conda production data along with the Golder's 2019 geological model described in Item 14 and concluded the following with regard to ore loss / mining recovery and dilution. Golder is aware that reverse circulation (RC) drilling samples are collected at 2-ft intervals; and thus, induces dilution of the sample data. Because the RC data was utilized in the construction of the 2019 block model, additional grade dilution was not recommended.

In order to account for the ore loss that may occur due to handling of the ore, Golder assumed a mining loss of 3%. Based on the site visits, Golder observed that the mining operations manage ore loss in the following ways:

- Trench delineation of the ore and overburden contacts is used to survey, stake, and flag the contacts.
- Shovels stop short of the ore contacts.
- Dozers with specially outfitted side blades are used to closely follow the bedding orientation shaving layers to separate the ore and overburden to minimize mining loss and dilution.
- Excavators with bucket sizes from 5 cy to 22 cy are used to load ore piles placed and precisely segregated by ore bed using the dozer method.

- Stockpiles are surveyed and the ore technicians are present to direct and observe the dozing and excavating of the ore.
- Ore technicians also delineate each bed of ore and interburden and collect samples to reconcile the resource model.

Based on the mining sequence, overburden, interburden, and Mineral Resource blocks were aggregated to produce estimated annual overburden and ore quantities and average ore grades. Based on the pit advance and blocks sequenced each year, production costs were estimated for the mining operations. See Items 16 and 21 for further information on the mining plans and cost estimates, respectively.

Using the estimated capital and operating costs associated with the mine plans, an economic analysis was performed to demonstrate the economics of the phosphate ore produced in the mine plan, see Item 22. The discounted cash flow economic analysis demonstrated that the annual CPP transfer prices paid for the phosphate ore produced by the mine plan are all well within the GMAs to be paid for the ores on a per ton of P_2O_5 basis FOB WV Tipple. The estimated transfer prices to be paid for the RVM/LCM phosphate ore produced and loaded in the mine plan cover all operating costs of ore production, stockpiling and loading into rail cars, plus a margin sufficient to return all working capital and new capital invested; yield a 7% IRR on all capital invested; and cover all costs associated with final reclamation and mine closure after production ends. The 7% IRR is reasonable given the history, conditions and business prospects of the ongoing mining operations at the RVM and the LCM. On this basis, the QP determined that forecast phosphate ore tons produced were economically viable and thus converted Mineral Resources within the RVM and LCM block models into Mineral Reserves.

Estimated Mineral Reserves by Mine and Classification

Using the geological model, modifying factors and methods described in this report, the QP converted Measured and Indicated Mineral Resources described in Item 14 into the estimated Mineral Reserves shown on Table 15-2. The Mineral Resources stated in Item 14 are inclusive of the Mineral Reserve estimates shown on Table 15-2.

Table 15-2: Estimated Mineral Reserves - Effective Date July 1, 2019

Deposit	Classification	Ore (Mt – dry) ^{ab}	P ₂ O ₅ (% wt) ^c	Waste (MBcy) ^d	Strip Ratio (MBcy:Mt)
Rasmussen Valley (RVM) ^e	Probable	0.9	26.6	n/a	
	Proven	11.2	26.6	n/a	
	Total RVM	12.2	26.6	50	4.1
Lanes Creek (LCM) ^f	Probable	0.3	28.8	n/a	
	Proven	0.5	28.0	n/a	
	Total LCM	0.8	28.3	1.9	2.4
Total RVM+LCM	Probable	1.2	27.1	n/a	
	Proven	11.7	26.7	n/a	
	Total RVM+LCM	13	26.7	51.9	4.0
Stockpiles ^g	Proven	1.4	25.9	n/a	
Total Reserves ^f	Probable+Probable Reserves	14.4	26.6	n/a	

Notes:

n/a = not applicable.

(a) A moisture content of 10% was assumed to convert from wet short tons to dry short tons.

(b) A 97% mining recovery and 0% dilution was applied to the tons selected as ore.

(c) A P₂O₅ cutoff grade of 20% was assigned as the minimum required grade to be considered ore.

(d) All blocks that are not selected as ore, including blocks classified as Inferred were not considered ore.

(e) A pit optimization analysis was performed on the RVM deposit, which incorporated the geotechnical parameters, mining costs of \$3.83/t wet overburden, \$7.27/t wet ore, ore stockpiling and tipples costs of \$1.32/t wet and royalties that varied with grade and averaged approximately \$1.70/t wet. A Gross Margin available per mined P₂O₅ ton (applied at the point of exchange at the tipples) of \$271/dry ton was used to define the limits of the mining pits.(f) A pit optimization analysis was performed on the LCM deposit, which incorporated the geotechnical parameters, mining costs of \$4.56/t wet overburden, \$11.34/t wet ore (including royalty), ore stockpiling and tipples costs of \$1.32/t wet. A Gross Margin available per mined P₂O₅ ton (applied at the point of exchange at the tipples) of \$271/dry ton was used to define the limits of the mining pits.(g) All stockpiles, which includes LCM ex-pit, WV Tipples, and Plant stockpiles, total dry tons and average P₂O₅ grades are displayed.

The estimated Mineral Reserves stated in Table 15-2 comply with all disclosure requirements for mineral reserves set out in NI 43-101, including NI 43-101 Items 2.2, 2.3, and 3.4.

Potential Impacts to Mineral Resource Estimates

The extent to which the Mineral Reserve estimates could be materially affected by mining, metallurgical, infrastructure, permitting, and other relevant factors that are different than the factors used in the PFS and described in this report is shown by the sensitivity analysis provided in Item 22. Because RVM and LCM are producing mines, infrastructure and permitting factors are not anticipated to materially affect the Mineral Reserve estimate.

Except for CPP GMAs, which are dependent primarily upon fertilizer prices and chemical plant costs, all other relevant mining and metallurgical factors related to RVM and LCM and described in this report are factors affecting the estimated operating costs summarized in Item 21 of this report. If for any reason any of these operating cost factors are changed such that operating cost estimates change materially, then the Mineral Reserve estimates stated in this report could be materially affected. However, as an example, if the cost factors are changed such that total operating and capital cost estimates are increased by 25%, the imputed transfer price in 2019 increases from \$163/ton to \$201/ton of P₂O₅ delivered FOB WV Tipples or about 23%. This imputed price remains below the 2019 GMA of \$269/ton as described in Item 19 and therefore the Mineral Reserve estimates

may remain unaffected. As of the effective date, there are no known cost factors that are materially different from the factors used in the PFS and summarized in this report to the extent that the Mineral Reserve estimates would be materially affected.

Revenues projected in the PFS economic analysis summarized in Item 22 depend upon forecast MAP net-back CPP and Itafos realized SPA prices that are used to calculate the GMAs described in this report. If the forecast prices of the CPP phosphate products over the study period decline by 25% or more, then the Mineral Reserve estimates will be materially and adversely affected. In this case, the GMA would be reduced to about \$135/ton of P₂O₅ delivered FOB WV Tipple, and the extent to which the Mineral Reserve estimates could be affected is estimated to be about a 35% to 45% reduction based upon the pit shell analysis described in this Report.

16.0 MINING METHODS

This Item describes the current or proposed mining methods and provide a summary of the relevant information used to establish the amenability or potential amenability of the mineral resources or mineral reserves to the proposed mining methods. The mining methods applied made due consideration of the following:

- (a) Geotechnical, hydrological, and other parameters relevant to mine or pit designs and plans;
- (b) Production rates, expected mine life, mining unit dimensions, and mining dilution factors used;
- (c) Requirements for stripping, underground development, and backfilling; and
- (d) Required mining fleet and machinery.

Golder was retained by Itafos to develop an updated mine plan for the RVM pit and the LCM pit based on the resources discussed in Item 14.0. The following sub-items summarize the assessment of the Open Pit Project.

16.1 Geotechnical

The pit slope parameters used in the preparation of the open pit mine for both the RVM and the LCM are based on the Call & Nicholas, Inc. (CNI) report "Updated Feasibility Slope Angles for the Planned Rasmussen Valley Open Pit Phosphate Mine." The report was reviewed and considered adequate for the purposes of designing pits for inclusion in a PFS level study. A summary of the geotechnical design parameters is provided below in Table 16-1

Table 16-1: RVM and LCM Geotechnical Parameters

Rock Type	Bench Width (ft)	Bench Height (ft)	Bedding Dip (°)	Bench Face Angle (°)	Inner-ramp slope Angle (°)
Unconsolidated	n/a	80	n/a	34	n/a
Chert	20	80	n/a	59	49
Phosphate Zone	20	80	n/a	59	49
Limestone	0	n/a	0-35	0-35	0-35
	30	80	35-45	35-45	35
	30	80	45-55	45-55	40
	30	80	55-59	55-59	43
	30	80	>59	59	45

16.2 Pit Design

Golder completed a mine design for the RVM using the geotechnical parameters from Item 16.1 and access parameters suitable for the equipment currently mining the pits. The pit shells along with the various modeled ore beds, were used as guides to prepare the RVM ultimate pit design and phase designs. Itafos Conda provided the LCM ultimate pit design, which was then combined with the June 2019 mined-out surface to create the ultimate mine design.

Haul Road Design Parameters

The majority of the haul roads were designed to be double-lane; however, single-lane roads were used, as required, to access the bottom-most benches in the phase designs. As seen in Figure 16-1, the double-lane sections of the haul ramp were designed to accommodate three times the width of a 100-st class haul truck with additional clearance for a berm and ditch. Single-lane sections were designed to accommodate two times the width of the haul trucks as shown in Figure 16-2. A 5-ft high berm is required on the outside of the ramps for safe operation. A 1-foot wide ditch was also included on the inside of the haul ramp to allow for drainage of surface water. The total width of the double-lane ramp was calculated to be 80 feet, and the total width of the single-lane ramp was calculated to be 58 feet.

Figure 16-1: Double-Lane Design for 100-ton Class Haul Truck (Golder, 2019)

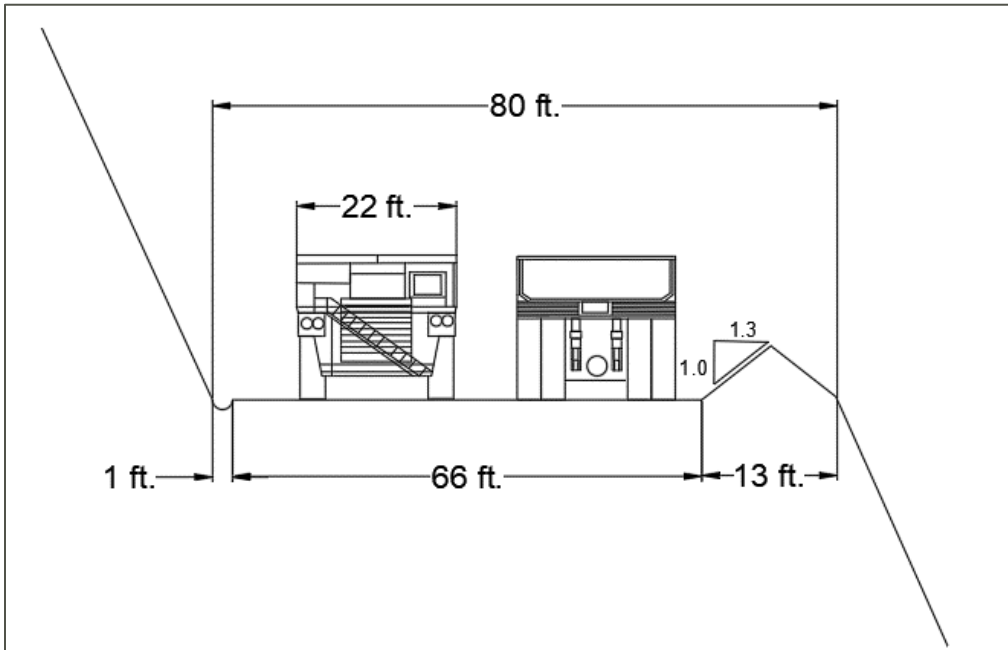
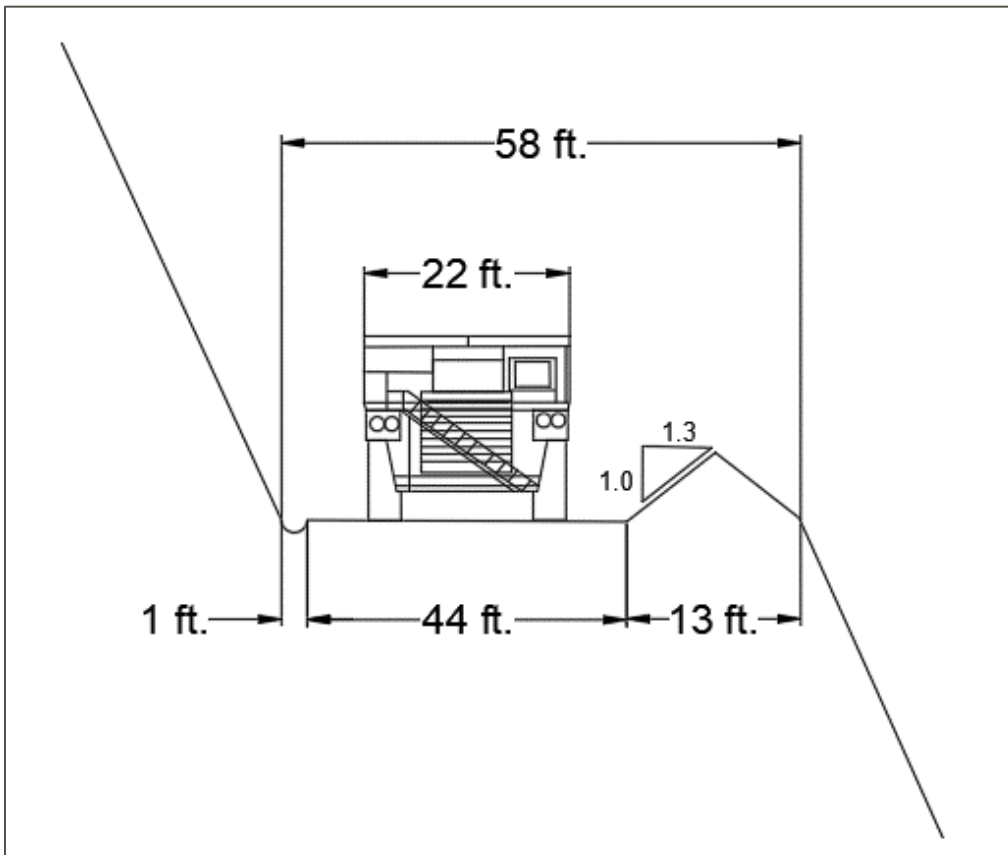
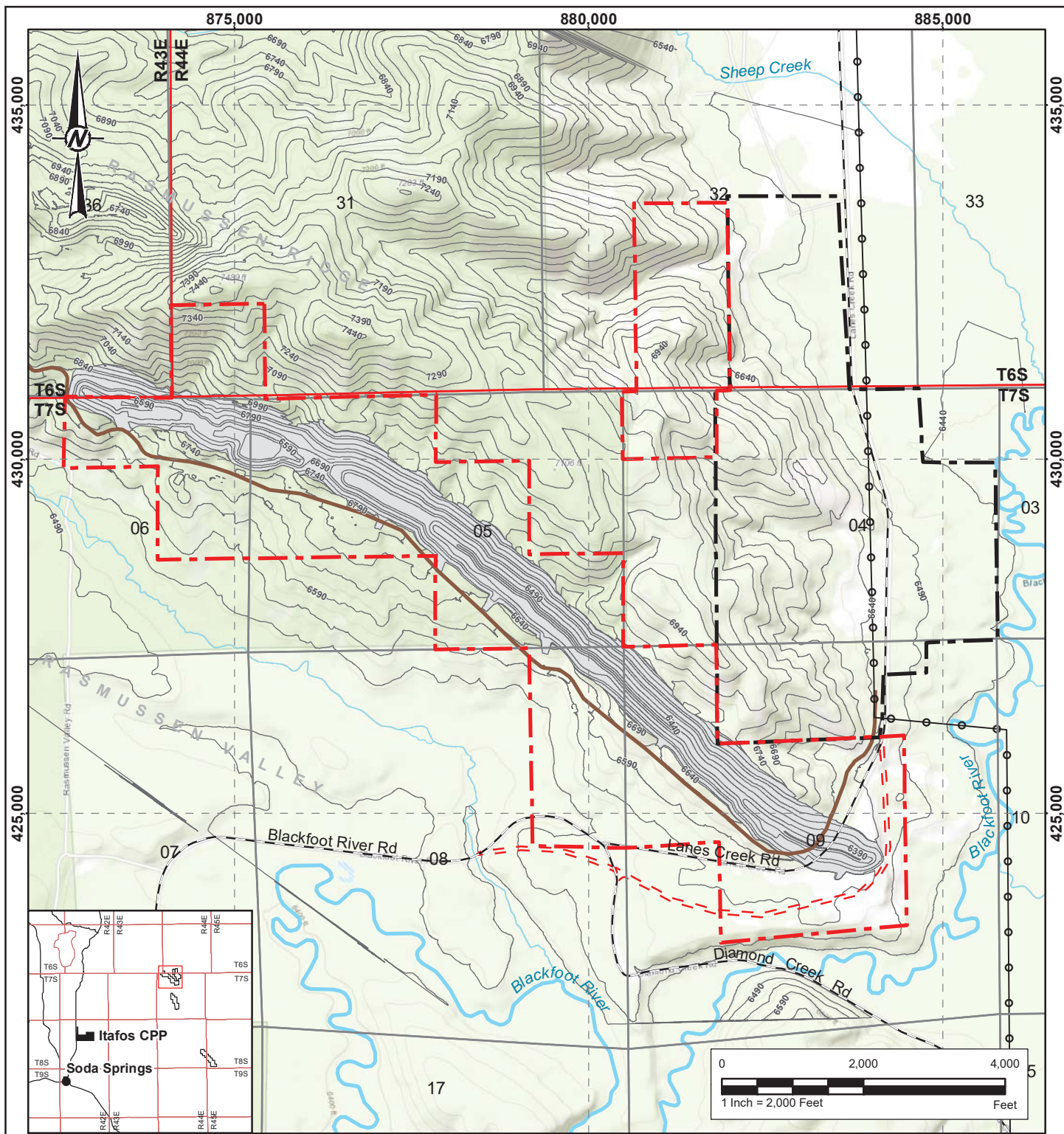

Figure 16-2: Single-Lane Design for 100-ton Class Haul Truck (Golder, 2019)



RVM Mine Design

The RVM ultimate and phase designs were completed using the geotechnical parameters from Item 16.1, the selected pit shell from Item 14.3 , and the ramp design parameters from Item 0 The ultimate design is shown in Figure 16-3. A total of 10, individual phase designs were prepared to facilitate the RVM mine plan schedule.



LEGEND

- - - RVM Lease Boundary
- - - LCM Lease Boundary
- Township and Range
- Section
- Ultimate Pit Design
- Road
- Future Road Realignment
- Haul Road
- Powerline
- ~ River/Stream
- ~ Contour Surface (50 foot Interval)

REFERENCE(S)

1. COORDINATE SYSTEM: NAD 1983 STATE PLANE IDAHO EAST FIPS 1101 FEET
2. DATA PROVIDED BY ITAFOS CONDA LLC

CLIENT
ITAFOS CONDA LLC

PROJECT
NI 43-101 TECHNICAL REPORT FOR CONDA PHOSPHATE OPERATIONS

TITLE
RASMUSSEN VALLEY MINE ULTIMATE PIT DESIGN

CONSULTANT	YYYY-MM-DD	2019-11-22
DESIGNED	-	
PREPARED	EFT	
REVIEWED	TM	
APPROVED	TM	



PROJECT NO.	CONTROL	REV.	FIGURE
18114499	0001	-	16-3

1 in IF THIS MEASUREMENT DOES NOT MATCH WHAT IS SHOWN, THE SHEET SIZE HAS BEEN MODIFIED FROM: ANSI/A

LCM Mine Design

The LCM ultimate design (Figure 16-4) was used to calculate the pit reserves. The production schedule was based on the ultimate design provided by Itafos Conda and the updated block model created by Golder, Item 14.0. The mined-out surface (latest June 2019 surveyed surface) and the existing Itafos Conda ultimate pit design was used to create a remaining ultimate pit design. At the time this Report was written, the LCM was in the final phase of mining; therefore, no phase designs were required.

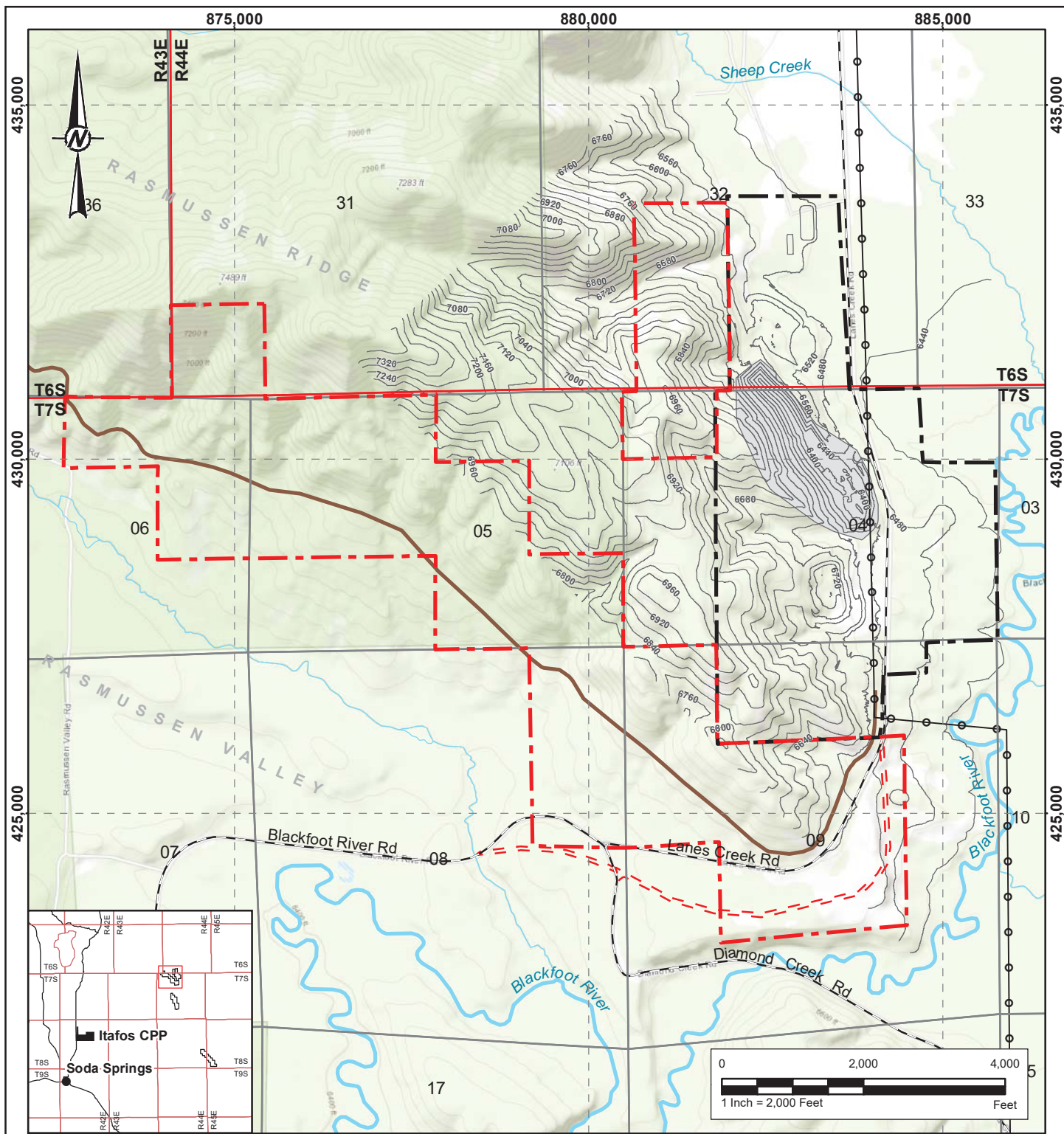

- LEGEND**
- RVM Lease Boundary
 - LCM Lease Boundary
 - Township and Range
 - Section
 - Ultimate Pit Design
 - Road
 - Future Road Realignment
 - Haul Road
 - Powerline
 - ~ River/Stream
 - ~ Contour Surface (40 foot Interval)

REFERENCE(S)
 1. COORDINATE SYSTEM: NAD 1983 STATE PLANE IDAHO EAST FIPS 1101 FEET
 2. DATA PROVIDED BY ITAFOS CONDA LLC

CLIENT
ITAFOS CONDA LLC

PROJECT
NI 43-101 TECHNICAL REPORT FOR CONDA PHOSPHATE OPERATIONS

TITLE
LANES CREEK MINE ULTIMATE PIT DESIGN

CONSULTANT	YYYY-MM-DD	2019-11-22
DESIGNED	-	
PREPARED	EFT	
REVIEWED	TM	
APPROVED	TM	



PROJECT NO.	CONTROL	REV.	FIGURE
18114499	0001	-	16-4

1 in IF THIS MEASUREMENT DOES NOT MATCH WHAT IS SHOWN, THE SHEET SIZE HAS BEEN MODIFIED FROM: ANS/A

Overburden Storage Area Design

Overburden storage area (OSA) designs were completed for the two mining areas. Golder considered existing topography and drainage systems when preparing the OSA designs. Any material that could not be dumped within the pit is hauled to a nearby pit.

16.3 Production Schedule

A combined RVM and LCM mine production schedule was prepared to provide 548 Kt dry of P₂O₅ annually to the CPP. The mine production schedule includes the existing temporary LCM stockpile and the RVM/LCM combined stockpile located at the WV Tipple. The mine production schedule was created using Minesight Strategic Optimizer (MSSO). MSSO uses IBM's™ CPLEX Optimizer to generate a schedule based on user-defined constraints and objectives, targeting 2.4 Mtpa (wet short tons) to the CPP wash plant per year. The annual mining progression for RVM is shown in Figure 16-7 through Figure 16-14. The annual mining progression for LCM is shown in Figure 16-15 and Figure 16-16. All figures are at the end of this Item. The mine production schedule is shown in Table 16-2.

Table 16-2: Mine Production Schedule to Wooley Valley Tipple^a

		2019 Q3	2019 Q4	2020 Q1	2020 Q2	2020 Q3	2020 Q4	2021	2022	2023	2024	2025	Total
RV Pit	Wet Tons (Mt)	0.3	0.3	0.2	0.4	0.6	0.5	2.2	2.3	2.3	2.3	1.9	13.5
	P ₂ O ₅ (% wt)	27.1	28.3	27.8	27.8	27.1	27.9	27.2	26.9	26.4	25.8	25.8	26.6
	MgO (% wt)	1.02	0.65	0.69	0.64	0.79	0.77	0.96	0.85	0.89	0.81	1.00	0.88
	Al ₂ O ₃ (% wt)	2.00	2.14	2.19	2.28	2.25	2.09	2.13	2.35	2.43	2.70	2.41	2.37
	Fe ₂ O ₃ (% wt)	0.84	0.81	0.83	0.90	0.85	0.87	0.80	0.85	0.88	0.94	0.86	0.87
LC Pit	Wet Tons (Mt)	0.2	0.3	0.3	0.0	0.0	0.0	0.0	0.0	0.0	0.0	0.0	0.8
	P ₂ O ₅ (% wt)	28.5	28.6	27.8	0.0	0.0	0.0	0.0	0.0	0.0	0.0	0.0	28.3
	MgO (% wt)	1.12	1.07	1.22	0.00	0.00	0.00	0.00	0.00	0.00	0.00	0.00	1.14
	Al ₂ O ₃ (% wt)	2.08	1.61	1.66	0.00	0.00	0.00	0.00	0.00	0.00	0.00	0.00	1.76
	Fe ₂ O ₃ (% wt)	0.78	0.73	0.70	0.00	0.00	0.00	0.00	0.00	0.00	0.00	0.00	0.73
LC Stockpile	Wet Tons (Mt)	0.1	0.0	0.0	0.2	0.0	0.0	0.0	0.0	0.0	0.0	0.0	0.28
	P ₂ O ₅ (% wt) ^b	27.0	0.0	26.3	26.0	0.0	0.0	0.0	0.0	0.0	0.0	0.0	26.2
	MgO (% wt) ^b	1.34	0.00	1.91	1.16	0.00	0.00	0.00	0.00	0.00	0.00	0.00	1.26
	Al ₂ O ₃ (% wt) ^b	1.34	0.00	1.42	1.53	0.00	0.00	0.00	0.00	0.00	0.00	0.00	1.48
	Fe ₂ O ₃ (% wt) ^b	0.48	0.00	0.53	0.54	0.00	0.00	0.00	0.00	0.00	0.00	0.00	0.53
Total Material to WV	Wet Tons (Mt)	0.6	0.6	0.6	0.6	0.6	0.5	2.2	2.3	2.3	2.3	1.9	14.6
	P ₂ O ₅ (% wt)	27.6	28.4	27.8	27.2	27.1	27.9	27.2	26.9	26.4	25.8	25.8	26.7
	MgO (% wt)	1.09	0.86	1.02	0.81	0.79	0.77	0.96	0.85	0.89	0.81	1.00	0.90
	Al ₂ O ₃ (% wt)	1.96	1.88	1.87	2.03	2.25	2.09	2.13	2.35	2.43	2.70	2.41	2.31
	Fe ₂ O ₃ (% wt)	0.78	0.77	0.75	0.78	0.85	0.87	0.80	0.85	0.88	0.94	0.86	0.85
RV Overburden	Wet Tons (Mt)	2.8	2.7	2.9	3.8	3.8	4.2	18.1	17.6	17.1	17.1	8.6	98.8
LC Overburden	Wet Tons (Mt)	1.2	1.3	1.3	0.0	0.0	0.0	0.0	0.0	0.0	0.0	0.0	3.8
Total Overburden	Wet Tons (Mt)	4.0	4.0	4.2	3.8	3.8	4.2	18.1	17.6	17.1	17.1	8.6	102.6
Total Material	Wet Tons (Mt)	4.6	4.6	4.8	4.4	4.5	4.8	20.3	19.9	19.4	19.4	10.6	117.2
Strip Ratio	Mbcy:wet ton	3.5	3.5	3.7	3.3	3.1	4.1	4.1	3.8	3.7	3.7	2.3	3.5

Notes: ^aSchedule includes a mining recovery of 97% and a 100% stockpile recovery, which is discussed in Item 15.0.

^bLC Stockpile grades were provided as P₂O₅ in-situ and washed. All other mineral grades were provided as washed. MgO was increased by 0.1 to convert from washed to in-situ grades. Fe₂O₃ and Al₂O₃ are reported in washed grades.

The production schedule, which meets the wash plant feed targets and balanced the total material movement, is shown in Figure 16-5.

Figure 16-5: Annual Production Schedule from RVM, LCM and Mine and Tipple Stockpiles Loaded at WV Tipple

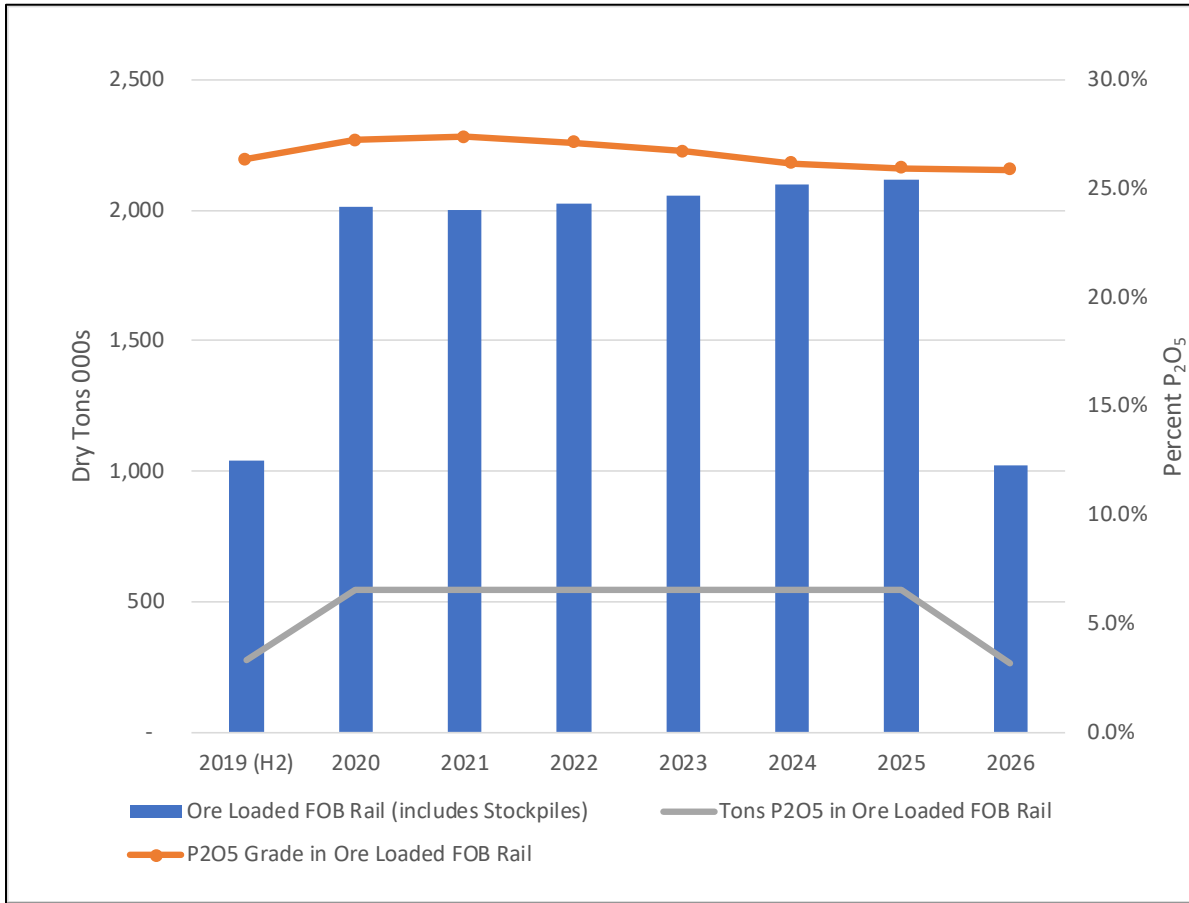

Source: (Golder, 2019).

The combined production shown in Table 16-2 was then rescheduled to include the Wooley Valley stockpile and the CPP stockpile for a blended CPP wash plant feed. The CPP produces MAP and SPA fertilizer products for sale in regional markets. Discussion of the fertilizer products market is in Item 19.0. As provided by Itafos Conda, the CPP requires 548,000 dry tons of P₂O₅ annually to meet the targeted annual fertilizer product production. The combined CPP wash plant feed schedule is shown in Figure 16-6. The values in this schedule have been adjusted to dry tons using a 10% moisture content.

Figure 16-6: Combined CPP Wash Plant Feed Schedule (Mine Production with Plant Stockpile) (Golder, 2019)

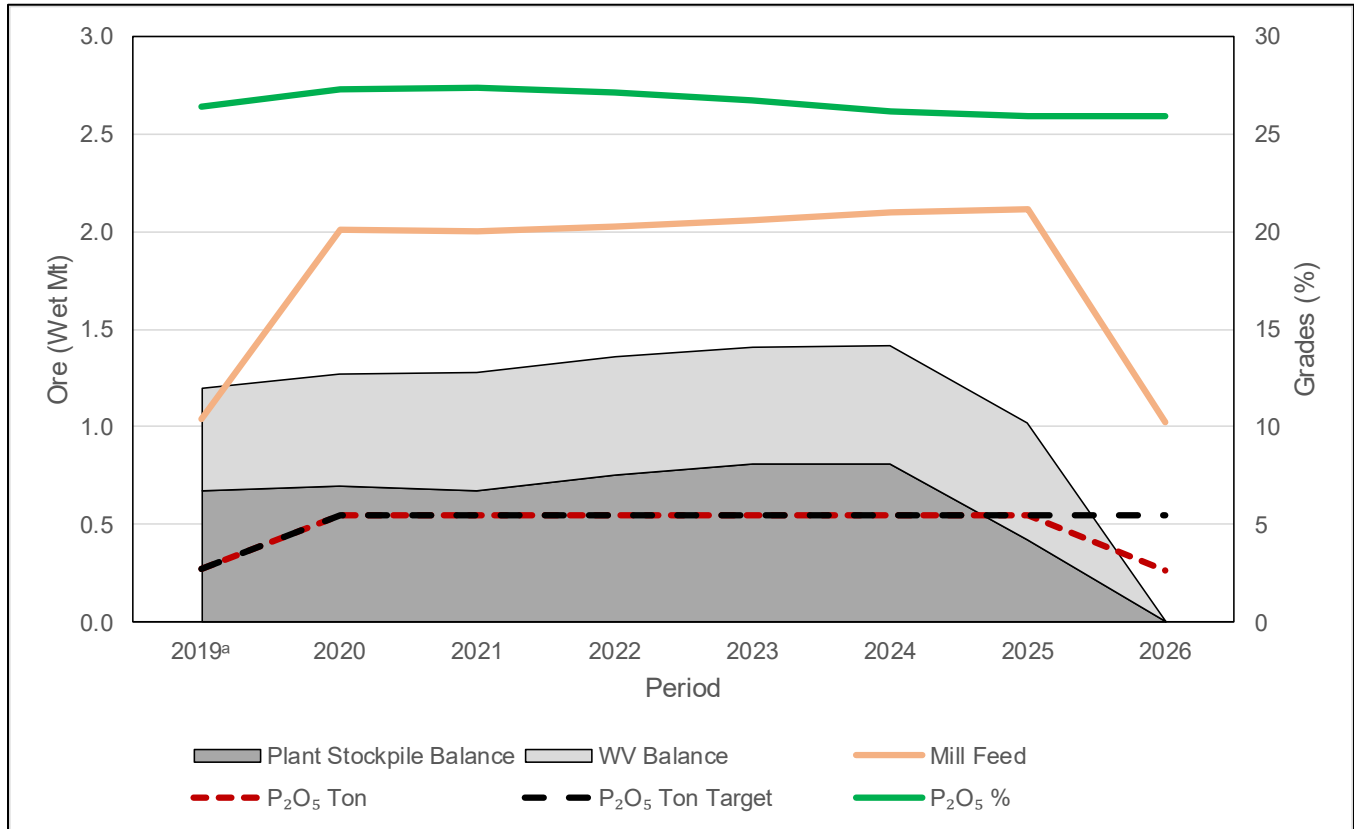

Notes: ^a2019 represents the second half of 2019 as all values were reported from July 1, 2019 onwards, therefore, total mill feed and P₂O₅ production differ from other years.

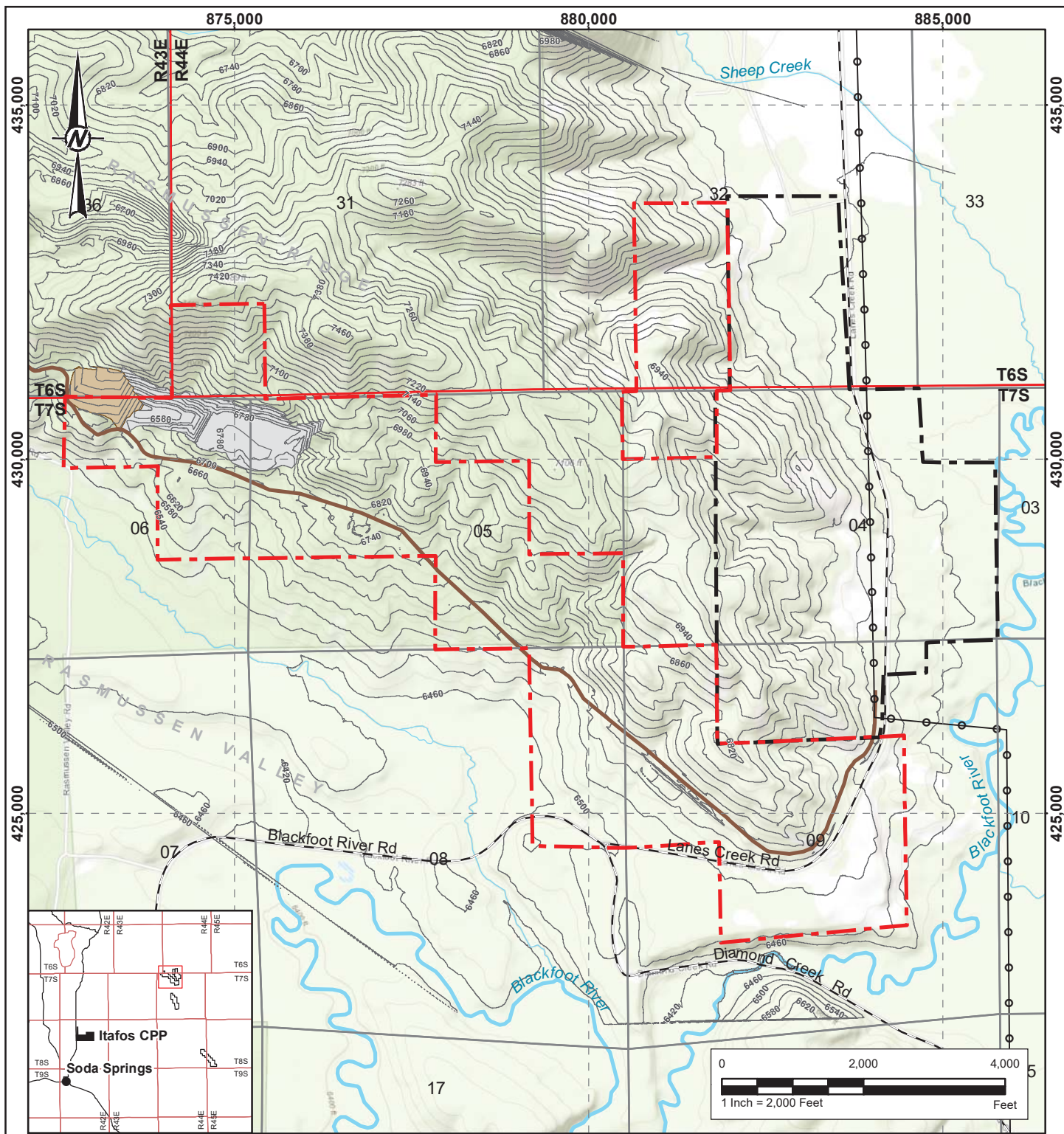

LEGEND

- RVM Lease Boundary
- LCM Lease Boundary
- Township and Range
- Section
- Active Mining Area
- Overburden Stockpile Area
- Road
- Haul Road
- Powerline
- ~ River/Stream
- ~ Contour Surface (40 foot Interval)

REFERENCE(S)

1. COORDINATE SYSTEM: NAD 1983 STATE PLANE IDAHO EAST FIPS 1101 FEET
2. DATA PROVIDED BY ITAFOS CONDA LLC

CLIENT
ITAFOS CONDA LLC

PROJECT
NI 43-101 TECHNICAL REPORT FOR CONDA PHOSPHATE OPERATIONS

TITLE
RASMUSSEN VALLEY MINE 2019 STATUS

CONSULTANT	YYYY-MM-DD	2019-11-21
DESIGNED	-	
PREPARED	EFT	
REVIEWED	TM	
APPROVED	TM	



PROJECT NO.	CONTROL	REV.	FIGURE
18114499	0001	-	16-7

1 in IF THIS MEASUREMENT DOES NOT MATCH WHAT IS SHOWN, THE SHEET SIZE HAS BEEN MODIFIED FROM: ANS/A

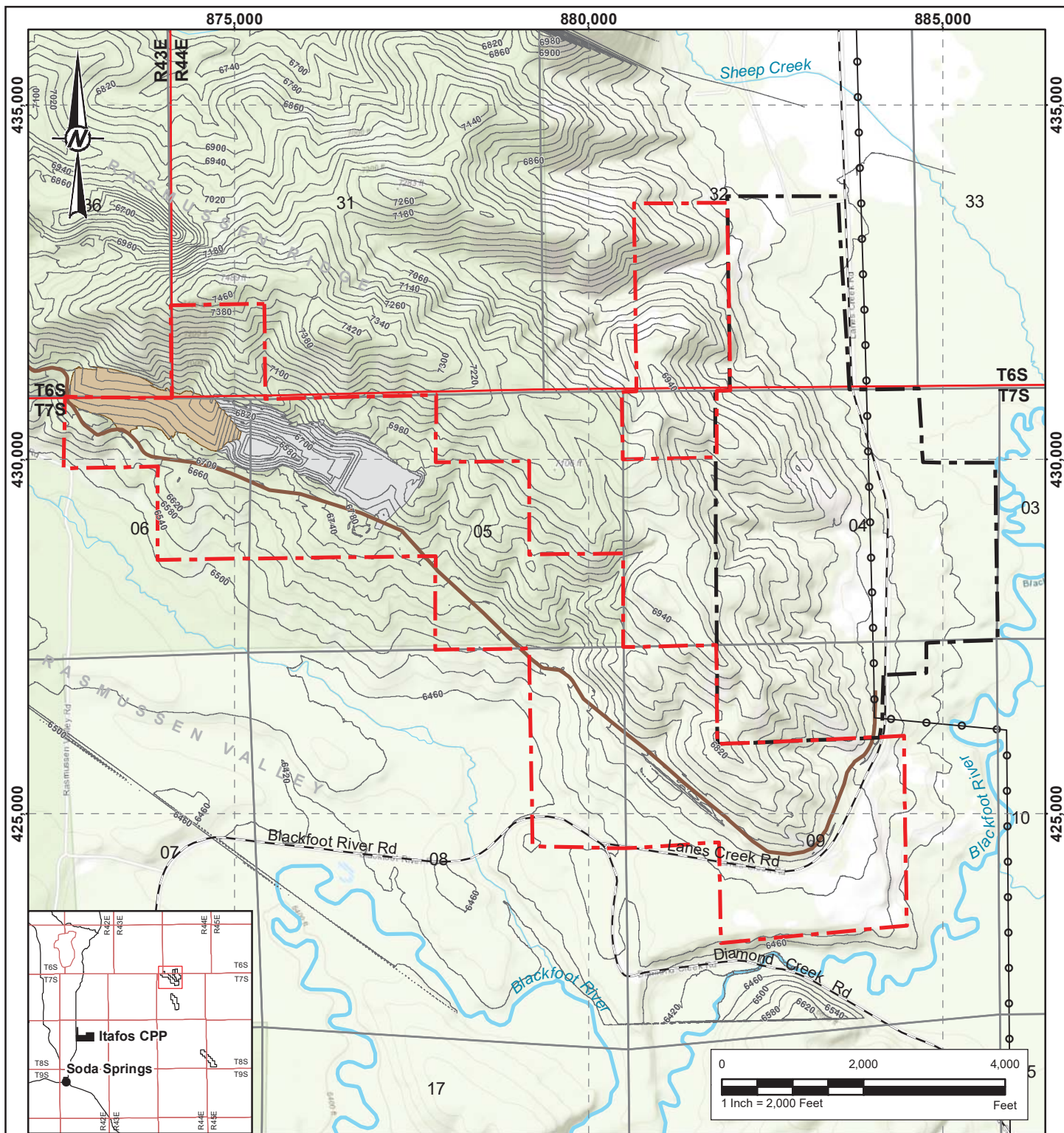

LEGEND

- ▬ RVM Lease Boundary
- LCM Lease Boundary
- Township and Range
- Section
- Active Mining Area
- Overburden Stockpile Area
- Road
- Haul Road
- Powerline
- ~ River/Stream
- ~ Contour Surface (40 foot Interval)

REFERENCE(S)

1. COORDINATE SYSTEM: NAD 1983 STATE PLANE IDAHO EAST FIPS 1101 FEET
2. DATA PROVIDED BY ITAFOS CONDA LLC

CLIENT
ITAFOS CONDA LLC

PROJECT
NI 43-101 TECHNICAL REPORT FOR CONDA PHOSPHATE OPERATIONS

TITLE
RASMUSSEN VALLEY MINE 2020 STATUS

CONSULTANT	YYYY-MM-DD	2019-11-21
DESIGNED	-	
PREPARED	EFT	
REVIEWED	TM	
APPROVED	TM	



PROJECT NO.	CONTROL	REV.	FIGURE
18114499	0001	-	16-8

1 in IF THIS MEASUREMENT DOES NOT MATCH WHAT IS SHOWN, THE SHEET SIZE HAS BEEN MODIFIED FROM: ANS I/A

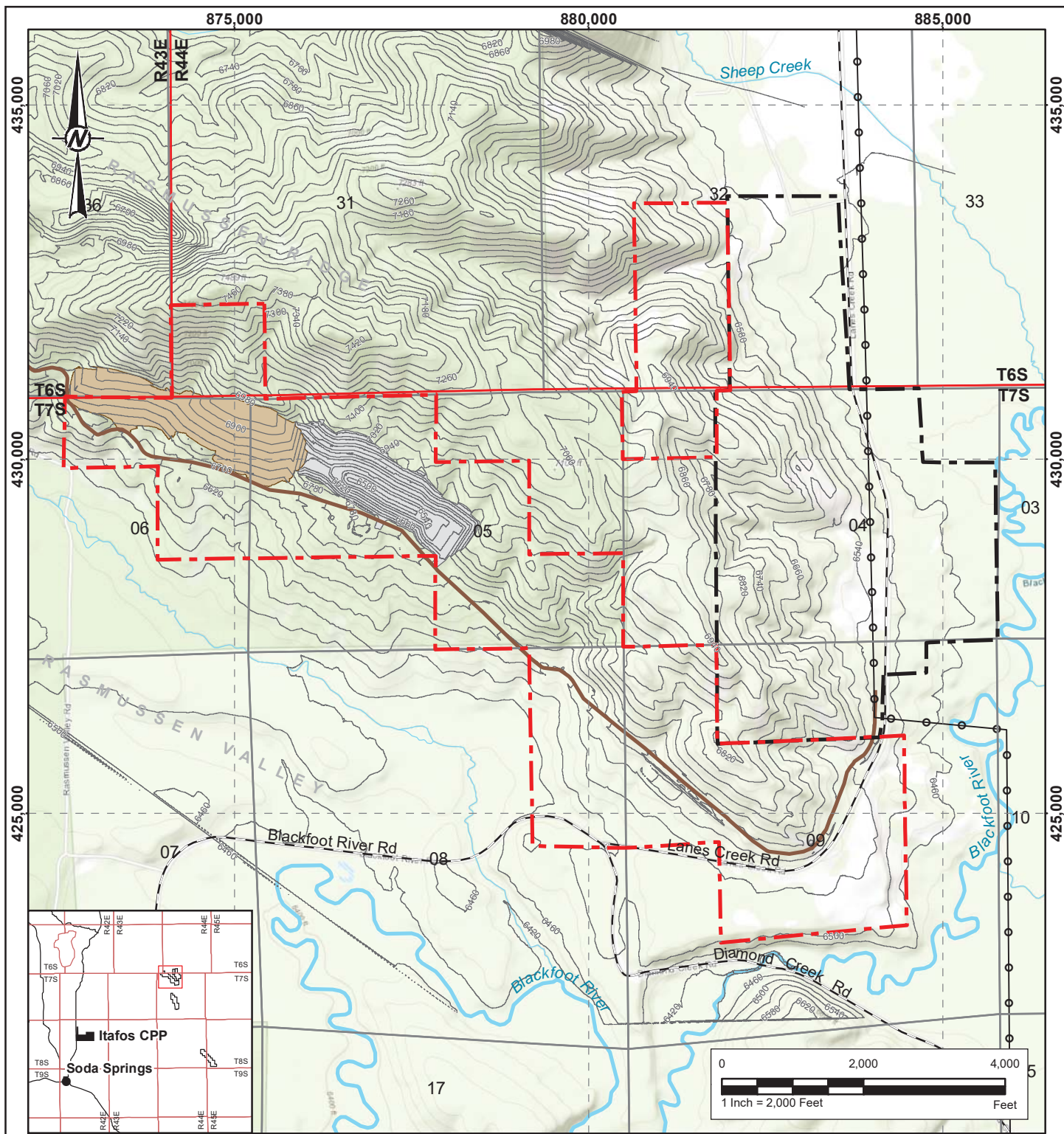

LEGEND

- ▬ RVM Lease Boundary
- LCM Lease Boundary
- Township and Range
- Section
- Active Mining Area
- Overburden Stockpile Area
- Road
- Haul Road
- Powerline
- ~ River/Stream
- ~ Contour Surface (40 foot Interval)

REFERENCE(S)

1. COORDINATE SYSTEM: NAD 1983 STATE PLANE IDAHO EAST FIPS 1101 FEET
2. DATA PROVIDED BY ITAFOS CONDA LLC

CLIENT
ITAFOS CONDA LLC

PROJECT
NI 43-101 TECHNICAL REPORT FOR CONDA PHOSPHATE OPERATIONS

TITLE
RASMUSSEN VALLEY MINE 2021 STATUS

CONSULTANT	YYYY-MM-DD	2019-11-21
DESIGNED	-	
PREPARED	EFT	
REVIEWED	TM	
APPROVED	TM	



PROJECT NO.	CONTROL	REV.	FIGURE
18114499	0001	-	16-9

1 in IF THIS MEASUREMENT DOES NOT MATCH WHAT IS SHOWN, THE SHEET SIZE HAS BEEN MODIFIED FROM: ANSII A

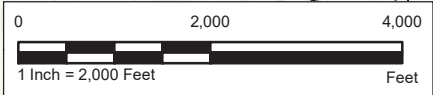
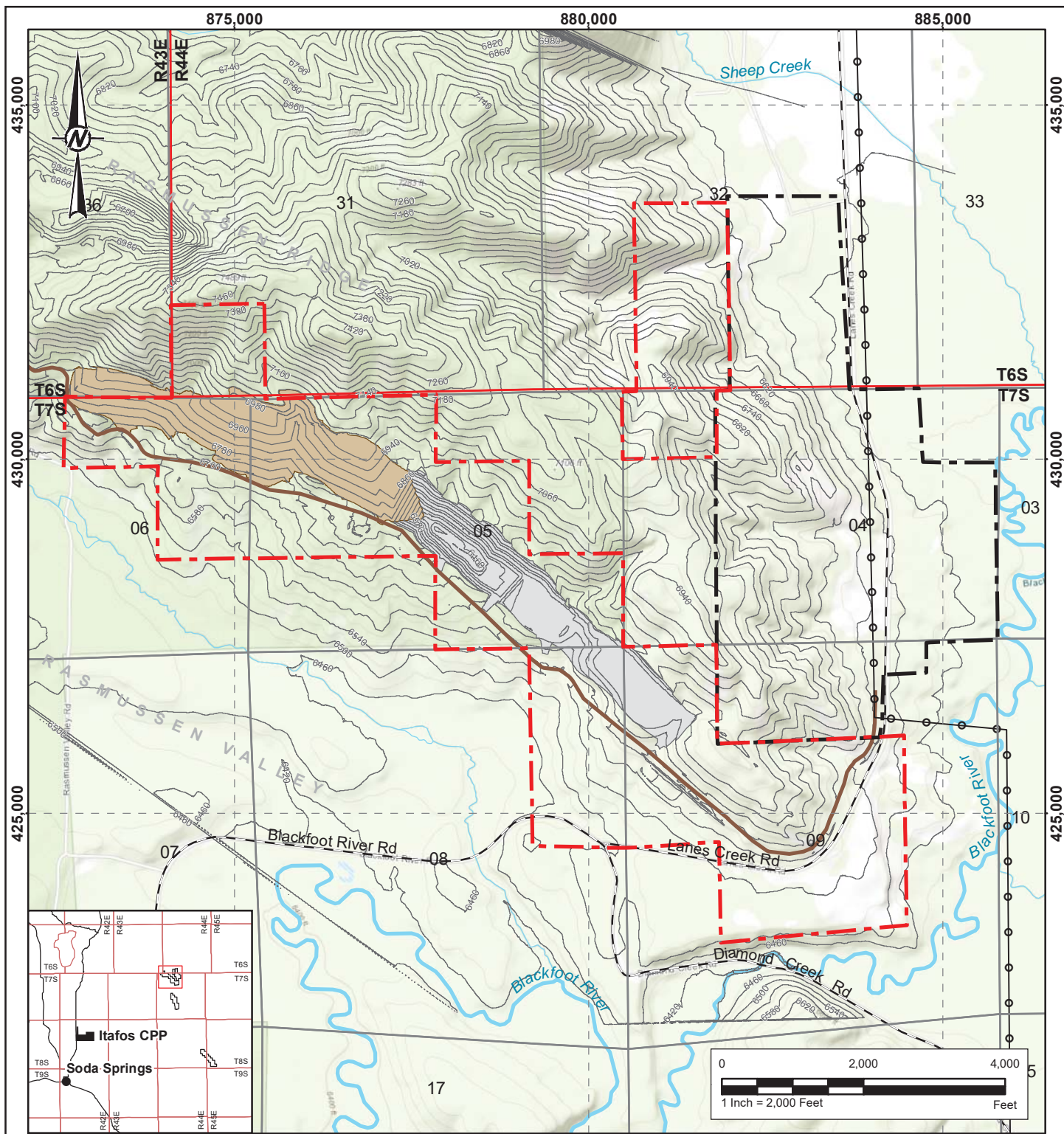

LEGEND

- ▬ RVM Lease Boundary
- LCM Lease Boundary
- Township and Range
- Section
- Active Mining Area
- Overburden Stockpile Area
- Road
- Haul Road
- Powerline
- ~ River/Stream
- ~ Contour Surface (40 foot Interval)

REFERENCE(S)

1. COORDINATE SYSTEM: NAD 1983 STATE PLANE IDAHO EAST FIPS 1101 FEET
2. DATA PROVIDED BY ITAFOS CONDA LLC

CLIENT
ITAFOS CONDA LLC

PROJECT
NI 43-101 TECHNICAL REPORT FOR CONDA PHOSPHATE OPERATIONS

TITLE
RASMUSSEN VALLEY MINE 2022 STATUS

CONSULTANT	YYYY-MM-DD	2019-11-21
DESIGNED	-	
PREPARED	EFT	
REVIEWED	TM	
APPROVED	TM	



PROJECT NO.	CONTROL	REV.	FIGURE
18114499	0001	-	16-10

1 in IF THIS MEASUREMENT DOES NOT MATCH WHAT IS SHOWN, THE SHEET SIZE HAS BEEN MODIFIED FROM: ANS/A

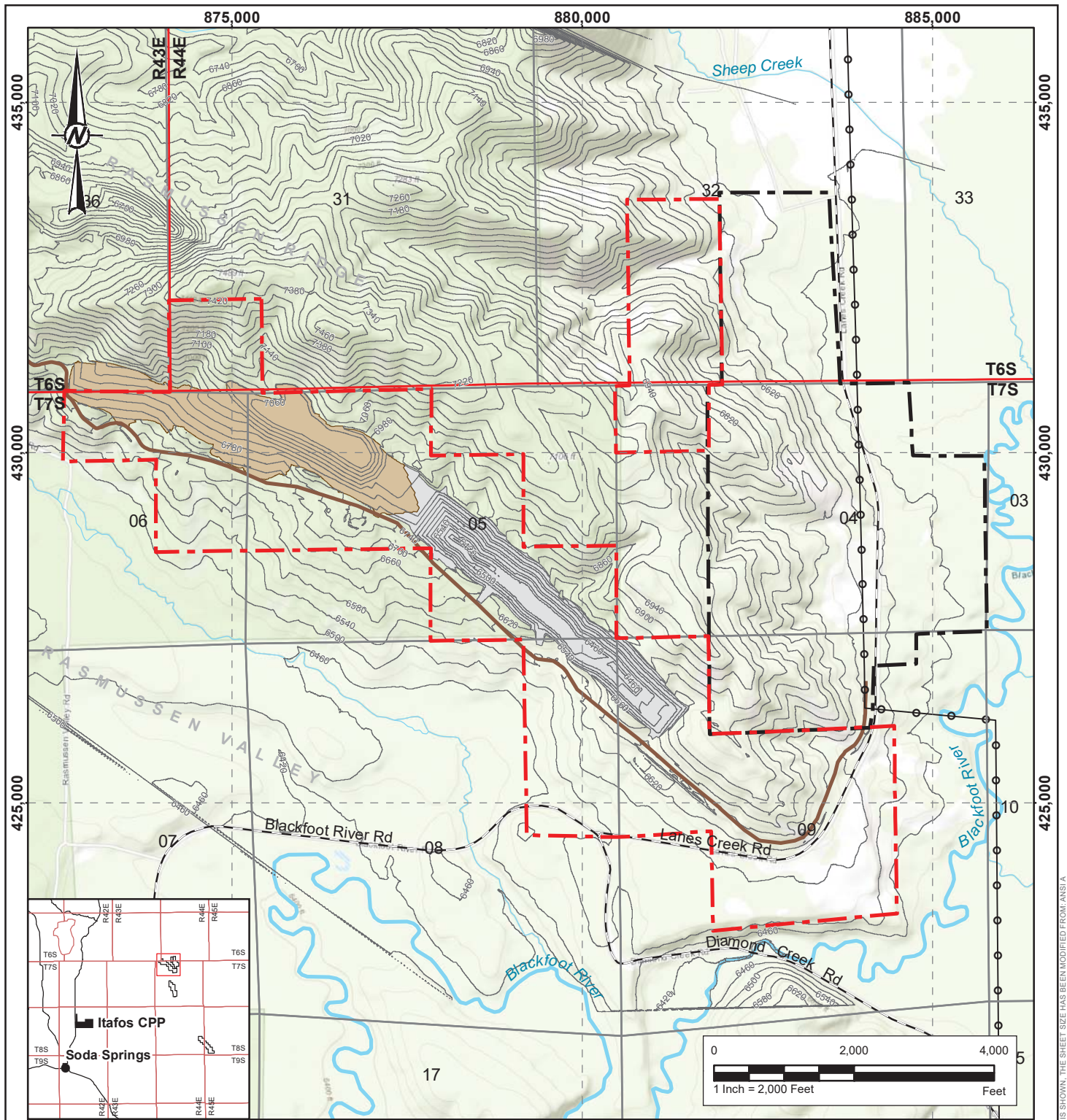

LEGEND

- RVM Lease Boundary
- LCM Lease Boundary
- Township and Range
- Section
- Active Mining Area
- Overburden Stockpile Area
- Road
- Haul Road
- Powerline
- ~ River/Stream
- ~ Contour Surface (40 foot Interval)

REFERENCE(S)

1. COORDINATE SYSTEM: NAD 1983 STATE PLANE IDAHO EAST FIPS 1101 FEET
2. DATA PROVIDED BY ITAFOS CONDA LLC

CLIENT
ITAFOS CONDA LLC

PROJECT
NI 43-101 TECHNICAL REPORT FOR CONDA PHOSPHATE OPERATIONS

TITLE
RASMUSSEN VALLEY MINE 2023 STATUS

CONSULTANT	YYYY-MM-DD	2019-11-21
DESIGNED	-	
PREPARED	EFT	
REVIEWED	TM	
APPROVED	TM	



PROJECT NO.	CONTROL	REV.	FIGURE
18114499	0001	-	16-11

1 in IF THIS MEASUREMENT DOES NOT MATCH WHAT IS SHOWN, THE SHEET SIZE HAS BEEN MODIFIED FROM: ANS I/A

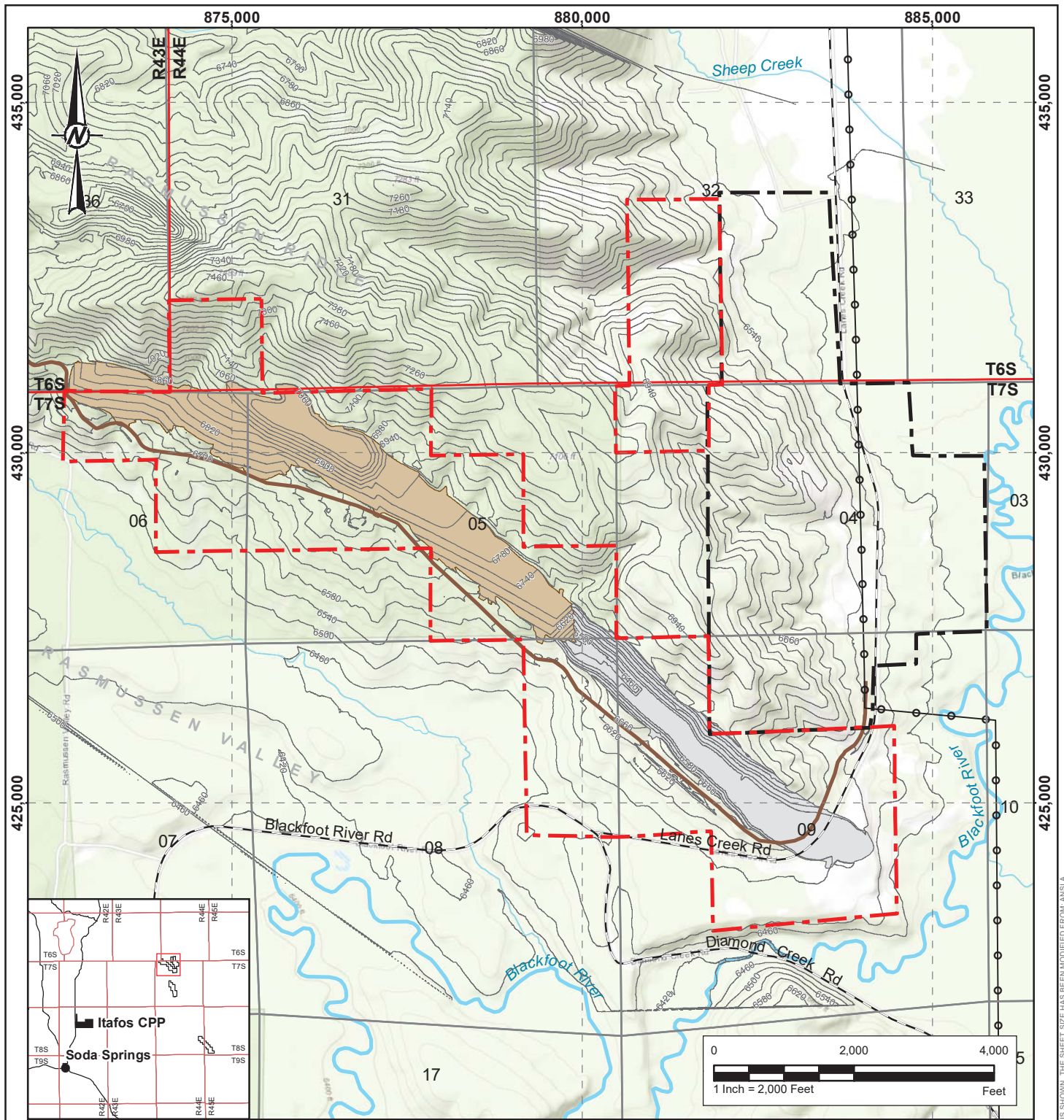

LEGEND

- ▬ RVM Lease Boundary
- LCM Lease Boundary
- Township and Range
- Section
- Active Mining Area
- Overburden Stockpile Area
- Road
- Haul Road
- Powerline
- ~ River/Stream
- ~ Contour Surface (40 foot Interval)

REFERENCE(S)

1. COORDINATE SYSTEM: NAD 1983 STATE PLANE IDAHO EAST FIPS 1101 FEET
2. DATA PROVIDED BY ITAFOS CONDA LLC

CLIENT
ITAFOS CONDA LLC

PROJECT
NI 43-101 TECHNICAL REPORT FOR CONDA PHOSPHATE OPERATIONS

TITLE
RASMUSSEN VALLEY MINE 2024 STATUS

CONSULTANT



YYYY-MM-DD	2019-11-21
DESIGNED	-
PREPARED	EFT
REVIEWED	TM
APPROVED	TM

PROJECT NO.
18114499

CONTROL
0001

REV.

-

FIGURE
16-12

1 in IF THIS MEASUREMENT DOES NOT MATCH WHAT IS SHOWN, THE SHEET SIZE HAS BEEN MODIFIED FROM: ANS/A

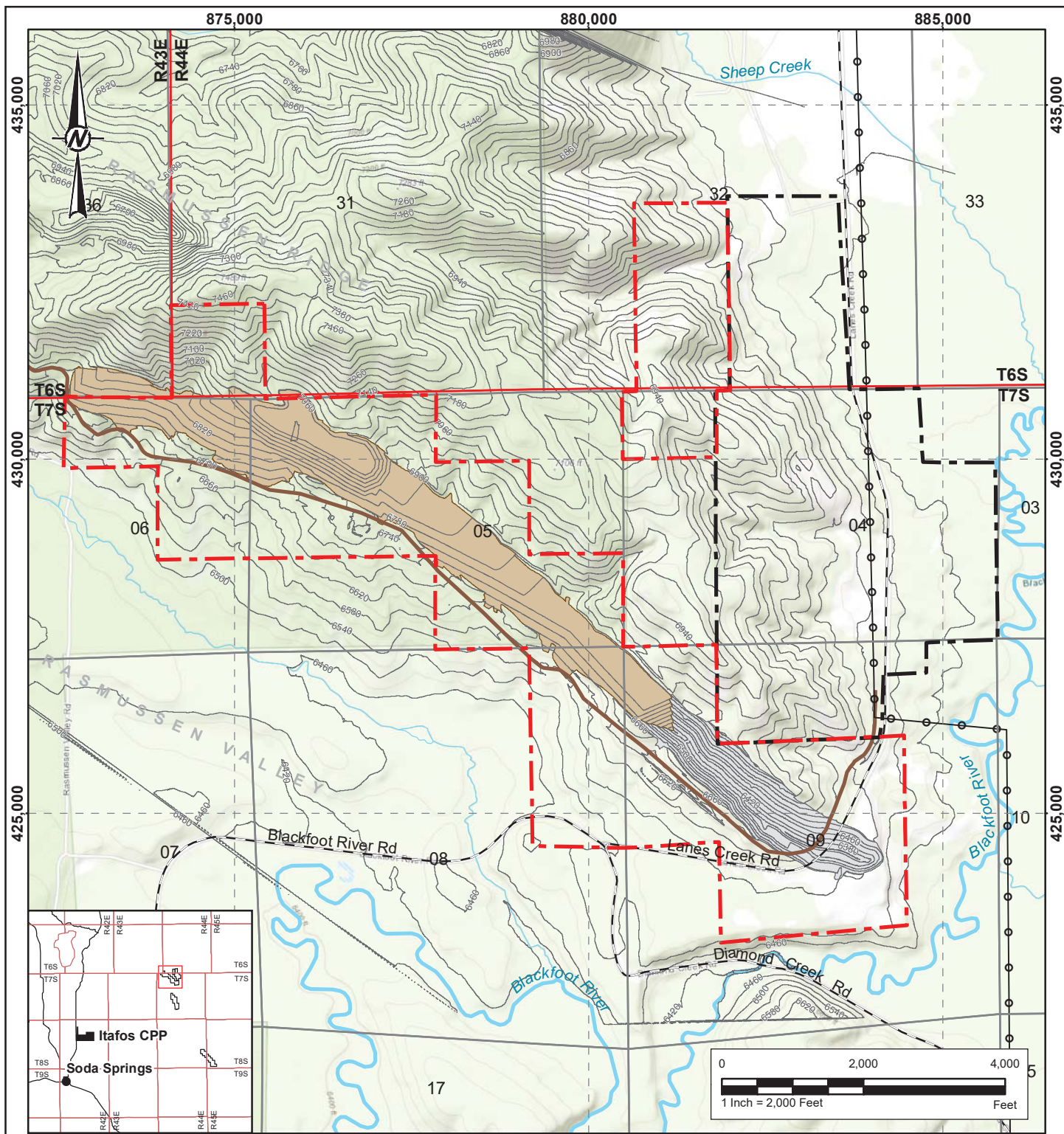

LEGEND

- ▬ RVM Lease Boundary
- LCM Lease Boundary
- Township and Range
- Section
- Active Mining Area
- Overburden Stockpile Area
- Road
- Haul Road
- Powerline
- ~ River/Stream
- ~ Contour Surface (40 foot Interval)

REFERENCE(S)

1. COORDINATE SYSTEM: NAD 1983 STATE PLANE IDAHO EAST FIPS 1101 FEET
2. DATA PROVIDED BY ITAFOS CONDA LLC

CLIENT
ITAFOS CONDA LLC

PROJECT
NI 43-101 TECHNICAL REPORT FOR CONDA PHOSPHATE OPERATIONS

TITLE
RASMUSSEN VALLEY MINE 2025 STATUS

CONSULTANT	YYYY-MM-DD	2019-11-21
DESIGNED	-	
PREPARED	EFT	
REVIEWED	TM	
APPROVED	TM	



PROJECT NO.	CONTROL	REV.	FIGURE
18114499	0001	-	16-13

IF THIS MEASUREMENT DOES NOT MATCH WHAT IS SHOWN, THE SHEET SIZE HAS BEEN MODIFIED FROM: ANSI/A 11in

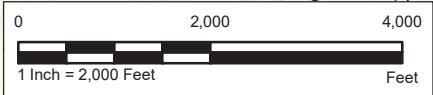
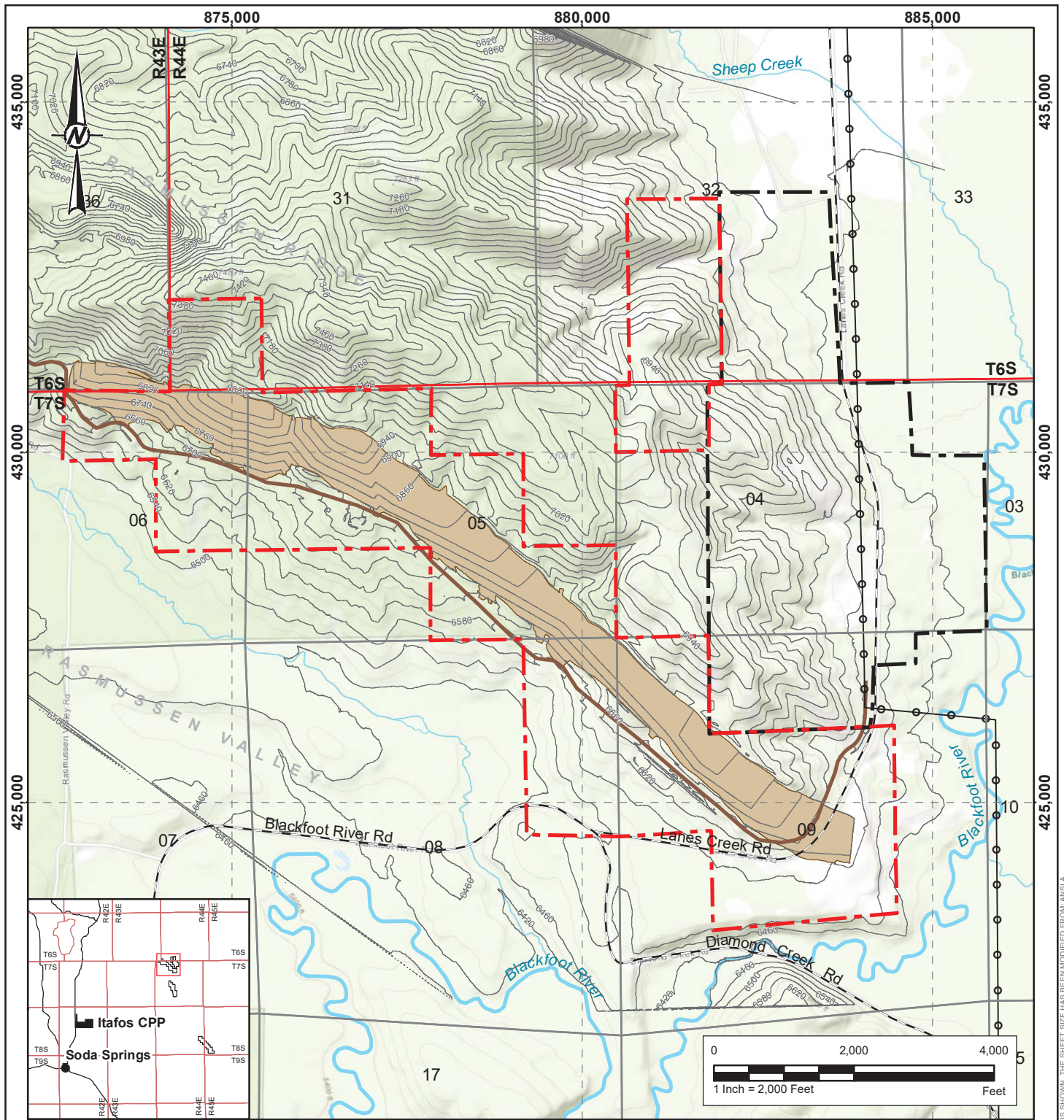

LEGEND

- ┌───┐ RVM Lease Boundary
- LCM Lease Boundary
- Township and Range
- Section
- Overburden Stockpile Area
- Road
- Haul Road
- Powerline
- ~ River/Stream
- ~ Contour Surface (40 foot Interval)

REFERENCE(S)

1. COORDINATE SYSTEM: NAD 1983 STATE PLANE IDAHO EAST FIPS 1101 FEET
2. DATA PROVIDED BY ITAFOS CONDA LLC

CLIENT
ITAFOS CONDA LLC

PROJECT
NI 43-101 TECHNICAL REPORT FOR CONDA PHOSPHATE OPERATIONS

TITLE
RASMUSSEN VALLEY MINE 2026 STATUS

CONSULTANT	YYYY-MM-DD	2019-11-21
DESIGNED	-	
PREPARED	EFT	
REVIEWED	TM	
APPROVED	TM	



PROJECT NO.	CONTROL	REV.	FIGURE
18114499	0001	-	16-14

1 in IF THIS MEASUREMENT DOES NOT MATCH WHAT IS SHOWN, THE SHEET SIZE HAS BEEN MODIFIED FROM: ANS/A

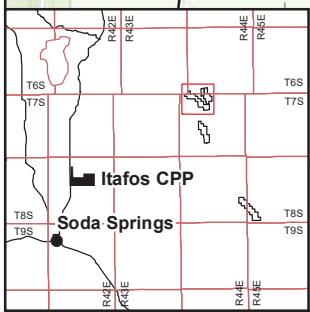
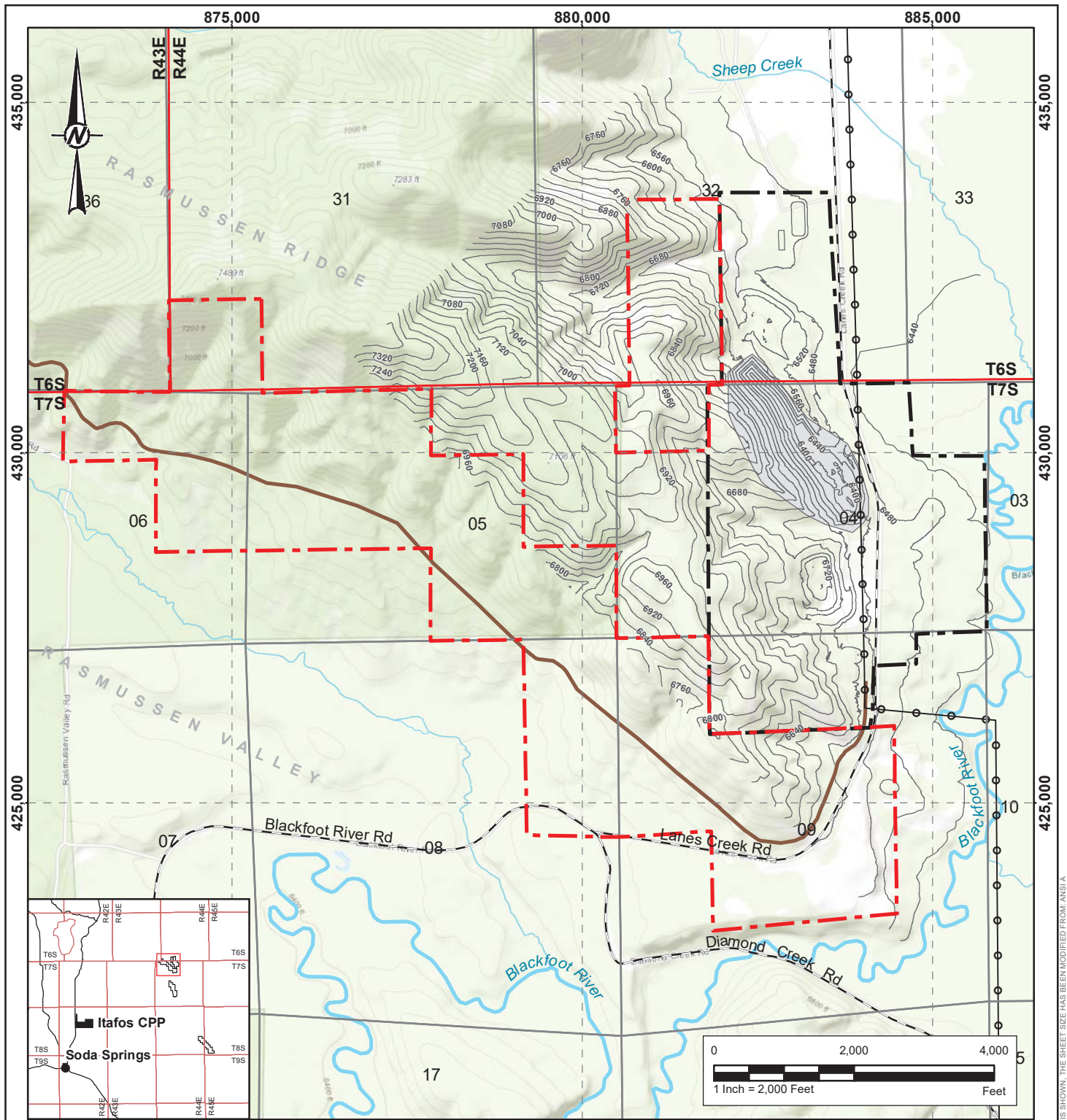

LEGEND

- - - RVM Lease Boundary
- - - LCM Lease Boundary
- Township and Range
- Section
- Mined Out Surface
- Road
- Haul Road
- Powerline
- ~ ~ ~ River/Stream
- ~ ~ ~ Contour Surface (40 foot Interval)

REFERENCE(S)

1. COORDINATE SYSTEM: NAD 1983 STATE PLANE IDAHO EAST FIPS 1101 FEET
2. DATA PROVIDED BY ITAFOS CONDA LLC

CLIENT
ITAFOS CONDA LLC

PROJECT
NI 43-101 TECHNICAL REPORT FOR CONDA PHOSPHATE OPERATIONS

TITLE
LANES CREEK MINE 2019 STATUS

CONSULTANT	YYYY-MM-DD	2019-11-22
DESIGNED	-	
PREPARED	EFT	
REVIEWED	TM	
APPROVED	TM	



PROJECT NO.	CONTROL	REV.	FIGURE
18114499	0001	-	16-15

1 in IF THIS MEASUREMENT DOES NOT MATCH WHAT IS SHOWN, THE SHEET SIZE HAS BEEN MODIFIED FROM: ANS/A

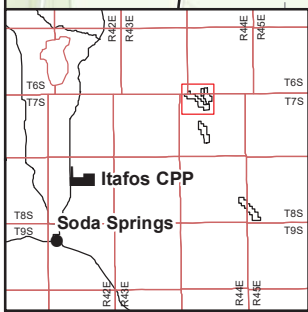
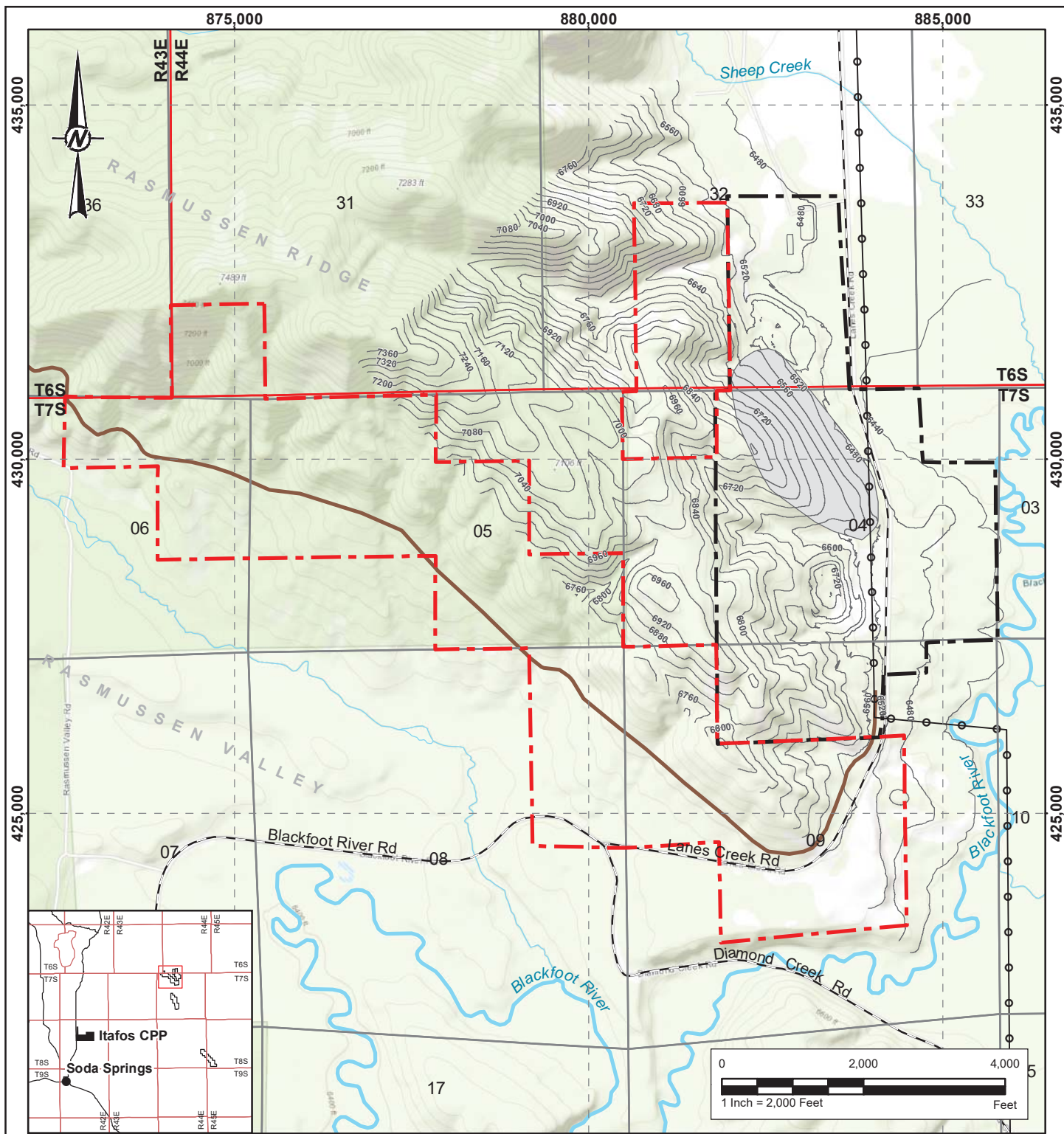

LEGEND

- - - RVM Lease Boundary
- - - LCM Lease Boundary
- Township and Range
- Section
- Reclaimed Surface
- Road
- Haul Road
- Powerline
- ~~~~~ River/Stream
- ~~~~~ Contour Surface (40 foot Interval)

REFERENCE(S)

1. COORDINATE SYSTEM: NAD 1983 STATE PLANE IDAHO EAST FIPS 1101 FEET
2. DATA PROVIDED BY ITAFOS CONDA LLC

CLIENT
ITAFOS CONDA LLC

PROJECT
NI 43-101 TECHNICAL REPORT FOR CONDA PHOSPHATE OPERATIONS

TITLE
LANES CREEK MINE 2020 STATUS

CONSULTANT	YYYY-MM-DD	2019-11-22
DESIGNED	-	
PREPARED	EFT	
REVIEWED	TM	
APPROVED	TM	



PROJECT NO.	CONTROL	REV.	FIGURE
18114499	0001	-	16-16

1 in IF THIS MEASUREMENT DOES NOT MATCH WHAT IS SHOWN, THE SHEET SIZE HAS BEEN MODIFIED FROM ANSII A

17.0 RECOVERY METHODS

No ore processing occurs at any of the mineral projects. However, phosphate ores to be mined and delivered must be suitable for consumption by the CPP. Suitable for consumption means that delivered phosphate ores may be blended, if needed, and washed to meet certain quality characteristics required of the chemical plant feed. This Item includes information on the recovery methods use at the CPP Wash Plant that is used to process RVM and LCM ores to meet the requirements of the CPP. This Item also includes information on CPP Wash Plant upgrades that are likely to be needed to process mined tonnages delivered from the H1 and NDR mineral resources.

The process flowsheet for the CPP Wash Plant at Soda Springs was designed based on the characteristics of the phosphate ores of Idaho phosphate deposits. The characterization studies (see Item 13.0) indicate that the process flowsheet should be based on the following:

- Cleaning surface of coarse phosphate ores from impurities breaking loose weak inclusions, attached particles of slimes, and breaking aggregates of clayish material.
- Liberating the coarse phosphate particles from fine impurities avoiding the production of phosphate fines and losses.
- Separating fine impurities produced at -325-mesh size fraction (-44 μm) from coarse phosphate ore at 0.375 inch x 325 mesh (9,525 x 44 μm).

The above is achieved by feeding the material to the Wash Plant at -8 inch (-203,200 μm), and subject it to horizontal scrubbing, sizing, crushing and grinding, classification, and dewatering unit operations.

17.1 Wash Plant Description

The Wash Plant comprises physical unit operations to separate the phosphate minerals from aluminum silicates, clays, quartz, dolomite and carbonates, and iron bearing minerals, which are deemed to be impurities. For this purpose, the washing process starts with horizontal scrubbing to clean the phosphate ore surfaces and is then followed by sizing. Here, separation of the phosphate ore is carried out based on particle size. Liberation from impurities of the phosphate ore requires crushing of the coarsest fraction through an impact crusher. Then, the material crushed joins the medium size phosphate ore to be ground in a rod mill to complete the liberation of the phosphate ore. Again, sizing is necessary to separate the already liberated phosphate ore from the coarse-unliberated phosphate requiring to be further ground. The fine-liberated phosphate ore and fine impurities are sent to classification to separate the finest impurities (tailings) from coarser-liberated phosphate ore (Wash Plant concentrate). The Wash Plant concentrate is dewatered and stored; whereas, the tailings is sent to the Tailings Pond to settle and recycle water to the CPP. Finally, before utilization the Wash Plant concentrate is further ground in two ball mills to feed the PAP.

The process flowsheet is presented in Figure 17-1. This flowsheet summarizes the description of the process carried out at the CPP that is described in this Item.

Phosphate Ore Feed Reception

The CPP receives partially blended phosphate ore of four qualities, ROM, B+, High MgO, and High Al. Each of this type of phosphate ores is hauled from the mines to the CPP by unit trains, each transporting a specific type of phosphate ore. These trains with a nominal payload of 13,300 tons (133 cars of 100 tons capacity each) are hauled five days a week for 30 weeks per year from April through October. Each car is unloaded using a “rollover”

dumper, subject to sampling, to check the quality of the phosphate ore received from the mine, and directed by belt conveyors and stackers to the corresponding stockpile for ROM, B+, High MgO, and High Al. The phosphate ore inventory ranges from 0.44 Mt to 1.54 Mt.

Dozers are used to build and maintain the inventory stockpiles, to reclaim the phosphate ore from each quality stockpile, and to blend the different phosphate ores feeding the feeder hopper of the plant. This blended feed phosphate ore is screened over an 8-inch screen (203,200 µm); the +8-inch material (+203,200 µm) returns to the stockpiles, and the -8-inch phosphate ore (-203,200 µm) feeds the Plant.

Figure 17-1: Wash Plant Flowsheet

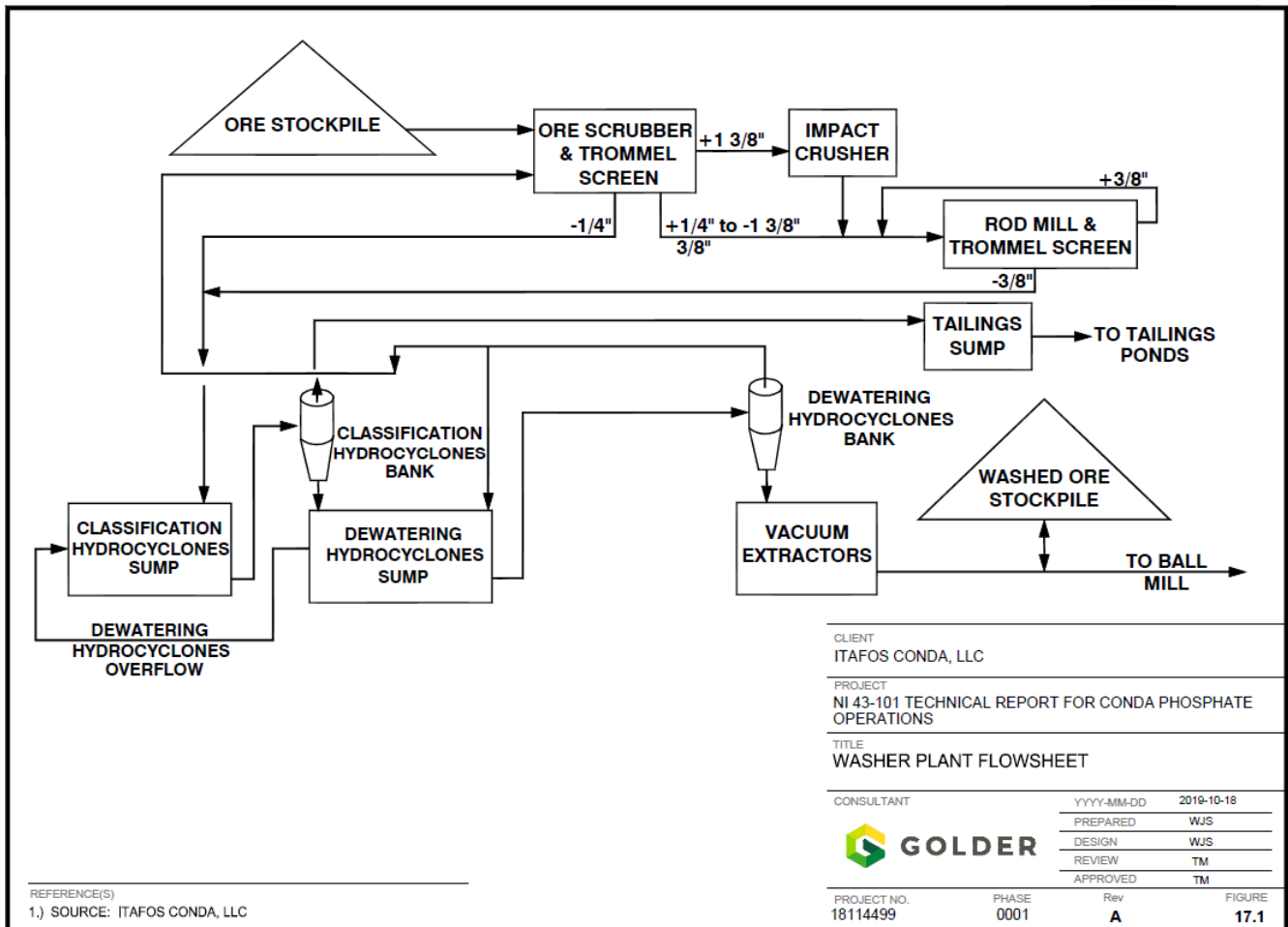

This -8-inch phosphate ore (-203,200 µm) is fed through a belt conveyor to the horizontal scrubber. The phosphate ore is weighed in a weight meter at this belt conveyor and sampled as well. Sampling is conducted to determine moisture, chemical analysis, and to carry out a simulation of the performance of the plant at the Chemical Laboratory. The phosphate ore feed rate to the horizontal scrubber is set to an average of 350 tph (dry).

Horizontal Scrubbing and Sizing

The phosphate ore feed is slurried to about 40% to 50% solids content using recycled water from the dewatering hydrocyclones and scrubbed in a 10 ft x12-ft Horizontal Scrubber. Here, the fluor or hydroxy-apatite surfaces are cleaned of attached impurities (slimes), weak inclusions, or attached impurities, and aggregates of clay minerals. Impure apatite will not be liberated of attached impurities at this stage.

Upon scrubbing, the discharge of the horizontal scrubber is submitted to sizing using a trommel to separate the valuable phosphate ore from the minerals containing impurities. This trommel consists of two concentric screens of 0.25 inch (6,350 μm), and a 1.375-inch aperture (34,925 μm). The -0.25-inch size fraction (-6,350 μm) is directed to classification, the 1.375x0.25-inch material (34,925x6,350 μm) is sent to the rod mill, and the +1.375-inch size fraction (+34,925 μm) is fed to an impact crusher.

Impact Crusher

The 8 x 1.375-inch coarse size fraction (203,200x34,925 μm), considered of medium hardness (about 9.0 kwh/t), is submitted to crushing in an impact crusher to liberate, at the coarser size fraction possible, the impure phosphate fluor or hydroxy-apatite from coarse dolomite and other impurities, such as aluminum silicates, clays, quartz, and iron bearing minerals.

This unit operation is carried out in an open circuit, receiving about 20% of the total plant feed (70 tph), and sending the crushed product to join the 1.375 x 0.25-inch size fraction (34,925 x 6,350 μm). Then, this material is pumped to feed the rod mill for further size reduction and liberation of impure fluor or hydroxy-apatite of contaminants. From the characterization studies (see Item 13. Mineral Processing and Metallurgical Testing), it is clear that liberation of the impure fluor or hydroxy-apatite of contaminants requires to be ground to -0.375 inch (-9,525 μm).

Rod Mill Grinding and Sizing

The final size reduction unit operation is conducted in an Allis Chalmers 9 ft x12-ft Rod Mill using 4-inch diameter rods. These 4-inch diameter rods are used to avoid excessive grinding, since the Bond Work Index is about 9.7 kwh/ton (considered soft in the rock hardness range). The rod mill is loaded to an occupied volume of 30% to 35% and operated at 64.8% C_s (16.56 rpm).

Then, the ground product is sized in a trommel attached to the rod mill. This trommel consists of two concentric screens of 0.375 inch (9,525 μm), and 1-inch openings (25,400 μm); thus, producing a +1 inch (+25,400 μm), 1 x 0.375 inch (25,400 x 9,525 μm), and -0.375-inch size fractions (-9,525 μm). A minimum amount of +1-inch material (+25,400 μm) is produced, and it is rejected. The 1x0.375-inch size fraction (25,400 x 9,525 μm) returns to the rod mill as circulating load to be reground, and the -0.375-inch size fraction (-9,525 μm) joins the -0.25-inch material (-6,350 μm) to be submitted to classification.

The rod mill uses the following operating conditions:

- Volume occupied in the mill = 30% to 35%
- Rotational speed = 16.56 rpm
- Critical Speed (% C_s) = 64.80%
- F_{100} = 1.375 inch (34,925 μm)

- $P_{80} = 947 \mu\text{m}$
- Installed power = 500 HP (373 kw)

Under these conditions used in grinding, the production of finer than 325-mesh material ($44 \mu\text{m}$) is limited to between 5.5% and 9.8%, contributing to a small fraction of the overall tailings (-325 mesh or $-44 \mu\text{m}$) of 32.11% produced (Ref. (3) Item 13).

Classification

The phosphate enriched particles from the scrubbing unit operation (-0.25 inch or $-6,350 \mu\text{m}$) and those from the rod milling unit operation (-0.375 inch or $-9,525 \mu\text{m}$) are joined in the Classification Sump. Here, recycled water from the Tailings Pond and from the dewatering hydrocyclones is added and the slurry is pumped to a five Krebs gMax-20 Hydrocyclones nest. These Krebs gMax-20 Hydrocyclones are designed for a cutting mesh of 325 mesh, or $44 \mu\text{m}$. Thus, this classification unit operation separates the enriched phosphate ore, 0.375 inch x 325-mesh size fraction ($9,525 \times 44 \mu\text{m}$) from the -325 -mesh material ($-44 \mu\text{m}$) that contains impurities, such as dolomite, quartz, aluminum silicates, clays, and iron bearing minerals (see Item 13 – Characterization Studies).

Three Krebs gMax-20 Hydrocyclones are in operation with two on standby. The overflow of these Krebs gMax-20 Hydrocyclones constitutes the final tailings of the CPP. This overflow is pumped to the Tailings Pond. The plant tailings is pumped at 11.24% solids content, contains 84.86% -325 -mesh particle size material ($-44 \mu\text{m}$), and correspond to a total of 32.11% wt. (yield) of the feed.

The underflow of the Krebs gMax-20 Hydrocyclones, 0.375 inch x 325-mesh material ($9,525 \times 44 \mu\text{m}$) of enriched phosphate ore is sent to a second sump where recycled water from the Tailings Pond, dewatering hydrocyclones, filter or extractors recycled water, make-up water, and raw water are added. Then, this 0.375 inch x 325-mesh product ($9,525 \times 44 \mu\text{m}$) is pumped to the dewatering unit operations.

The characteristics of the Krebs gMax-20 Hydrocyclones are:

- Feed inlet = 35.5 sq.in.
- Feed solids content = 20%
- Feed = 5,956 gpm
- Diameter = 20 inches
- Vortex finder = 8.25 inch
- Apex diameter = 4.5 inch
- Differential pressure = 18 psi
- Overflow solids content = 11.24%
- Overflow minus 325 mesh ($-44 \mu\text{m}$) = 84.96%
- Overflow yield = 32.11%
- Number of cyclones installed = 5, operating = 3, standby = 2.

The classification system's relative efficiency is 90.23% based on the 2018 to 2019 data at the cutting mesh of 325 mesh (44 μm) with an overall efficiency of the classification hydrocyclones of 69.23%.

Dewatering Unit Operations

Dewatering of the enriched 0.375 inch x 325-mesh phosphate ore (9,525x44 μm) is carried out in six Krebs D15B hydrocyclones followed by filtration in two belt filters (extractors). The dewatering hydrocyclones are fitted with a 3-inch diameter apex, and 6-inch diameter vortex finder. The dewatering hydrocyclones are arranged in two sets of three hydrocyclones each. Of these, five are in operation and one is on standby. The overflow of these dewatering hydrocyclones report low solids content (4.3%), which is low enough to be recycled as make-up water to the water distribution system of the plant. Namely, it is recycled to the sump of the dewatering hydrocyclones and to the feed chute of the horizontal scrubber.

The underflow of these dewatering hydrocyclones constitutes the feed to the belt filters, or extractors. The belt filters, or extractors, are EIMCO Model 67 types, with one of them including a blower for drying the cake. The cake produced contains 13.97% moisture and constitutes the concentrate at a 67.89% yield. This beneficiation product is stored in a bin, or transferred, using a reversible belt conveyor, to a stockpile with a total storage capacity of 60,000 tons.

Ball Mill Grinding

The Washer Plant concentrate is reclaimed by a belt conveyor from the stockpile using dozers, or front-end loaders, to feed a belt conveyor hopper. This belt conveyor feeds the chute of the North Ball Mill while a second one feeds the South Ball Mill. The product is ground in two FFE ball mills 11.5 ft x 21.5-ft running in parallel. These ball mills are fed with 0.375-inch x 325-mesh beneficiated phosphate concentrate (9,525x44 μm) to be ground to 98% -35-mesh size fraction (-420 μm) to allow an acceptable recovery in the PAP.

The grinding media fed to these mills is 2-inch diameter Cr-Mo steel balls under the following operating conditions:

- Volume occupied in the mill = 40% - 45%
- Rotation speed = 16.9 rpm
- Critical Speed (% C_s) = 74.80%
- F_{80} = 947 μm
- P_{80} = 420 μm
- Power installed per mill = 1,700 HP (1,260 kw)

The slurry of the enriched phosphate ore ground in the ball mills is stored in an agitated tank to be reclaimed, as needed, by the PAP.

Pumps and Belt Conveyors

The CPP Wash Plant includes pressure gauges and valves in selected hydrocyclones nests; gamma ray density meters in the overflow and underflow streams of the dewatering hydrocyclones; 13 horizontal-centrifugal pumps; and three vertical-centrifugal pumps.

The horizontal-centrifugal pumps are listed as follows:

- One Rod Mill Oversize pump
- Two Rod Mill Product (E and W) pumps
- One Classification Stage pump; 400 HP motor
- One Classification Hydrocyclone Underflow to Dewatering Hydrocyclones pump; 200 HP motor
- Two Tailings pumps (N and S); 300 HP motor each
- One Drier Discharge pump
- One Extractor Booster pump
- Two Ball Mill to PAP pumps (N and S)
- Tailings Pond Barge pump
- Tailings Pump Booster pump

The three vertical-centrifugal pumps are as follows:

- Two Wash Plant Floor pumps
- One Ball Mill Floor pump.

Two Extractor Vacuum pumps and a blower are also included in the Wash Plant.

The following belt conveyors are used in the Wash Plant to distribute the wet solid products:

- Horizontal Scrubber belt conveyor
- Inner Screen-Rod Mill belt conveyor
- Reversible Washed Product belt conveyor
- Washed Ore Bin belt conveyor
- Washed Ore Stockpile belt conveyor

Tailings Handling

The tailings containing fine phosphate ore with impurities, such as dolomite, quartz, aluminum silicates, clays, and iron bearing minerals, is pumped to the Tailings Pond using two horizontal centrifugal pumps (N and S) of 300 HP. The tailings is at 11.24% solids content and contain 84.86% -325-mesh particle size material (-44 μm), representing a total of 32.11% yield (weight percentage) of the feed.

At the Tailings Pond, the tailings is freely discharged forming a fine sand beach, and the decanted water is channeled to a deep-water recycling area. The recovered (decanted) water with negligible solids content is pumped back to the plant using a barge pump and a booster pump mounted in series at 65 to 95 pounds per square inch (psi) of pressure, respectively.

The dike around the Tailings Pond is elevated 1.6 ft per year to accommodate the tailings through 2035 with the current permitting. The maximum elevation of the dike projected is set at 6,235 ft, 23 ft over the current elevation.

17.2 Materials and Water Distributions

The total phosphate ore feed to the CPP Wash Plant is 350 tph, and the total amount of water use for the process to include raw/fire and potable/gland seal water by the plant, is estimated at 4471 gpm. The process water is distributed as follows:

In	Out
Feed water (moisture) = 174 gpm	Tailings water recycled = 3,908 gpm
Recycled water from Tailings Pond = 3,908 gpm	Concentrate Moisture+ball mill water = 563 gpm
Potable – gland seal water = 120 gpm	
Make-up water = 269 gpm	
Total In = 4,471 gpm	Total Out = 4,471 gpm

The material and water balance is shown in Figure 17-2 and shows only the average values for both materials and water. However, estimates are within a range of $\pm 25\%$ and, thus, the water usage could vary from 3,400 gpm to 5,600 gpm.

17.3 Process Control and Wash Plant Sampling

The Washer Plant sampling starts at the “rollover” of the unit train cars, where the actual quality of the phosphate ore received, and the corresponding stockpile for the ore (ROM, B+, High MgO, and High Al) is determined. A second control sample is obtained from the belt conveyor feeding the horizontal scrubber. Here, moisture content, P₂O₅, CaO, MgO, Al₂O₃, Fe₂O₃, and 10 more elements are analyzed at the Chemical Laboratory using ICP-OES. Similarly, a sample of the product (beneficiation concentrate) is obtained at the reversible belt conveyor receiving the filter cakes, and a sample of the tailings is obtained at the sump of the tailings pumps.

In addition to this daily sampling, the phosphate feed rate is controlled using a weight meter on the belt conveyor feeding the horizontal scrubber. The classification stage is controlled using a pressure gauge on the nest of the Krebs gMax-20 Hydrocyclones. Here, the tailings (overflow of the Krebs gMax -20 Hydrocyclones) is produced. The underflow is sent to the dewatering Krebs D15B Hydrocyclones, controlled by gamma ray density meters located in both the overflow (recycled water) and underflow, to then feed to the belt filters, or extractors.

The belt filters are controlled using the vacuum pressure pump and blower for drying the washed phosphate ore. This washed phosphate ore is weighed in a weight meter on the reversible Washed Product belt conveyor. Again, the feed to the ball mills is controlled using a weight meter.

The metallurgical balance is calculated using the phosphate ore feed, washed product, and tailings chemical analyses; as well as feed and washed product weights (see Item 13.8 Metallurgical Balance). Moisture is

obtained for the phosphate ore feed to the plant and the washed product at the Chemical Laboratory, and the solids content of the tailings is also determined from the samples that are sent to the Chemical Laboratory.

17.4 Performance

The performance of the CPP Wash Plant is described in Item 13, Metallurgical Balance and Table 13-6 Metallurgical Balance of the CPP (2018-2019) as well as in Item 17 (Materials and Water Distributions). The CPP Wash Plant operation results in the fulfillment of the specifications required by the PAP. The operation results in an enriched phosphate ore at the required specifications of 0.52% MgO and MER of 0.092.

The materials balance (Figure 17-2) show that the yield for beneficiation product was 67.89% (237.615 tph) while the tailings were 32.11% (112.385 tph). Also, the metallurgical balance (Item 13) shows that the feed to the CPP Wash Plant was 25.55% P₂O₅ with CaO of 36.68%, and impurities reported with 0.70% MgO, 3.22% Al₂O₃, 1.23% Fe₂O₃, and 19.14% SiO₂. Thus, the CaO/P₂O₅ Ratio was 1.436 and the MER was 0.202. After beneficiation, the product, or concentrate, is upgraded to 30.55% P₂O₅, and 43.49% CaO, with the impurities reduced to 0.52% MgO, 1.61% Al₂O₃, 0.68% Fe₂O₃, and 11.68% SiO₂. Thus, the CaO/P₂O₅ Ratio reports at 1.424 and a MER of 0.092. The final tailings were analyzed with 14.97% P₂O₅ and 22.29% CaO, with the impurities concentrated to 1.08% MgO, 6.62% Al₂O₃, 2.40% Fe₂O₃, and 34.95% SiO₂. Thus, the CaO/P₂O₅ Ratio and MER increased to 1.489 and 0.675, respectively. These resulted in a P₂O₅ recovery of 81.18%, with a rejection of 49.34% MgO, 66.10% Al₂O₃, 62.71% of Fe₂O₃, and 58.59% of SiO₂.

Finally, these metallurgical balance results are consistent with historical data (Agrim Nutrients, n.d., Historical Plant Description), and they show that the RVM and LCM phosphate ores do not present a risk to the MAP, SPA, and APP production and quality.

Figure 17-2: Materials and Water Balance – Conda Wash Plant Flowsheet

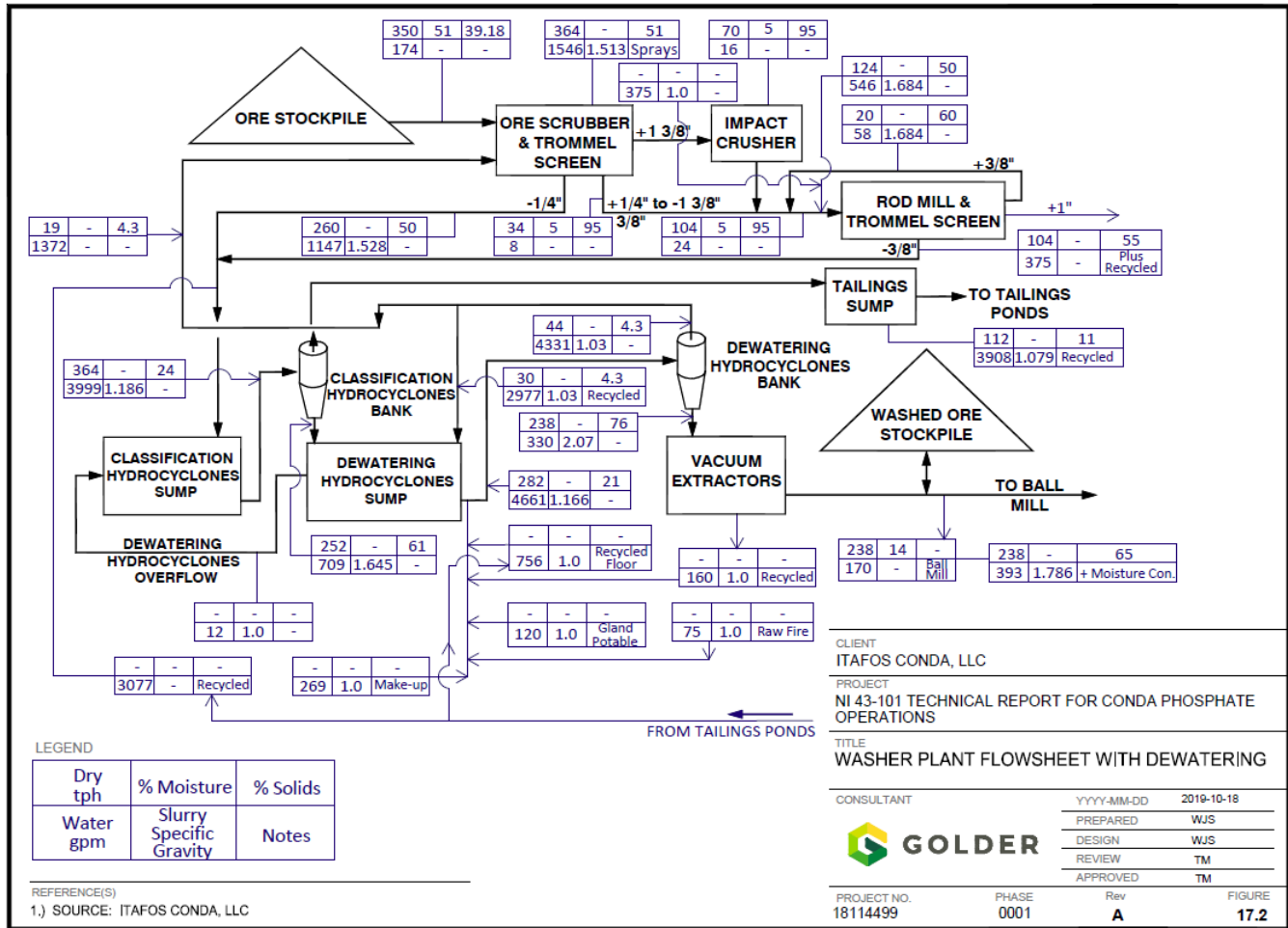

17.5 Wash Plant Upgrades for Processing H1 and NDR Ores

The mineral resource estimates disclosed for H1 and NDR in this TR indicated that additional processing will be required at the CPP Wash Plant for mined tonnages produced from the H1 and NDR resources. This Item describes the work to date regarding the wash plant updates that are likely to be required at the time of any development of H1 and NDR.

In the case of the H1 deposit, preliminary characterization and metallurgical studies were carried out by Albatross Environmental & Processing Consulting, Inc. for Itfos Conda from March 2014 to January 2015^(1,2,3). In addition, CPP recently conducted metallurgical studies on a phosphate ore composited from RVM and SRM ore and P4 LLC ore LOI#2 and LOI#3 prepared to simulate the chemical composition of H1 Phosphate Ore in both P₂O₅ and impurities contents. Based on these preliminary studies, it was found that further characterization studies were required for H1 as well complete characterization studies for NDR.

From the characterization studies of H1 (SGS Laboratories, November 5, 2013, pp. 59), it was inferred that the Wash Plant could result in desired phosphate product specifications of >30% P₂O₅ with <0.60% MgO, and about 10% SiO₂ by applying modifications to the present flowsheet. For this purpose, metallurgical studies on several unit operations will be required, including horizontal scrubbing, crushing, bed-comminution mechanisms (high

pressure grinding rolls or HPGR) to selectively crush dolomite reporting to tailings, attrition scrubbing, and limited flotation studies (see Item 26 Recommendations-Metallurgy).

Flotation studies on RVM LOI#2 and LOI#3 as a model for H1 phosphate ore were performed by Eriez Flotation Division/USA. These studies demonstrate that it is possible to achieve the required product specifications by selectively floating dolomite and silica using flotation feeds of narrow size fractions. The studies also indicate that flotation feed preparation using the Wash Plant is possible with modifications to maximize the quality of the flotation feed and reduce the flotation footprint.

This PEA incorporates the results of the characterization studies, a review of the washer unit operations, flotation feed preparation, flotation tests results, potential modified flowsheet, estimated CAPEX necessary, and conclusions. The potential modified flowsheet is provided in Figure 17-3.

Preliminary Characterization Studies

The preliminary characterization studies corresponded to chemical analyses, screen assays, and mineralogical and liberation studies. Two sets of characterization studies were considered including H1 Composites¹ and a model blend for H1 Phosphate Ore from RVM LOI#2 and LOI#3 material⁴.

Chemical Analyses

The chemical analysis for H1 Composite 1 and Composite 1+2, >20% P₂O₅⁽¹⁾ are shown in Table 17-1. This data corresponds to drill cores obtained during the 2012 Drilling Campaign of Agrium Nu-West Industries, Inc. The sample was crushed as received to -0.75 inch(-19,050 µm) without any type of scrubbing. Table 17-1 shows that Composite 1 corresponds to that of a fluorapatite or hydroxyapatite of 25.46% P₂O₅ with 2.27% Al₂O₃, 0.72% MgO, 0.88% Fe₂O₃, and 13.28% SiO₂. The evaluation parameters for Composite 1 resulted in a slightly higher CaO/P₂O₅ Ratio (1.563) than that of pure fluorapatite, or hydroxyapatite, indicating the presence of calcite and dolomite, and MER (0.152; which in turn, indicates the presence of impurities from dolomite, clays and aluminum silicates, and iron bearing minerals.) However, it could be observed that it is possible to achieve a product with higher grade than 30% P₂O₅, the Grade Potential being 30.73% P₂O₅. Nevertheless, Composite 1 still contained 0.72% MgO without separating the -325-mesh size fraction (-44µm).

Table 17-1: H1 Composite 1 and Composite 1+2, >20% P₂O₅

Product	Grades						Parameters		
	P ₂ O ₅ , %	CaO, %	P ₂ O ₅ , %	MgO, %	Fe ₂ O ₃ , %	SiO ₂ , %	CaO/P ₂ O ₅ Ratio	MER	Grade Potential
Composite 1	25.46	39.79	2.27	0.72	0.88	13.28	1.563	0.152	30.73
Composite 1+2*	20.98	37.50	2.63	1.62	1.02	15.14	1.807	0.256	26.13
Composite 1 (+44 µm)	27.51	42.11	1.75	0.59	0.67	10.62	1.531	0.109	31.85
Composite 1+2 (+44 µm)**	22.60	39.63	2.18	1.50	0.83	12.92	1.754	0.199	27.37

Notes:

* Estimated assuming equal amounts of each composites.

** Estimated according to remaining material at +44 µm.

Composite 1+2 was estimated by combining 1:1 ratio of Composite 1 and Composite 2. The results clearly showed the presence of calcite and dolomite in the ore, as reflected in a lower P_2O_5 grade (20.98% P_2O_5) with 2.63% Al_2O_3 , 1.62% MgO , 1.02% Fe_2O_3 , and 15.14% SiO_2 . This resulted in a higher CaO/P_2O_5 Ratio (1.807). The MER increased to 0.256 due to the increase in dolomite, clay and aluminum silicates, and iron bearing minerals. The grade Potential was 26.13% P_2O_5 .

Even though no scrubbing, crushing, and grinding were considered, as would be applied to this phosphate ore in the Wash Plant, sizing at 325 mesh (44 μm) resulted in a significant improvement in the quality of the phosphate ore for both Composite 1 and Composite 1+2, rejecting 17.54% wt. for a yield of 82.46% for Composite 1, and rejecting 19.04% for a yield of 80.96% for Composite 1+2. Composite 1 showed a 27.51% P_2O_5 grade with 1.75% Al_2O_3 , 0.59% MgO , 0.67% Fe_2O_3 , and 10.62% SiO_2 . The new parameters improved the CaO/P_2O_5 Ratio to 1.531, a MER of 0.109, and the Grade Potential increased to 31.85% P_2O_5 by rejecting the -325-mesh size fraction (-44 μm). Similarly, the Composite 1+2 resulted in a 22.60% P_2O_5 grade with 2.18% Al_2O_3 , 1.50% MgO , 0.83% Fe_2O_3 , and 12.92% SiO_2 . The CaO/P_2O_5 Ratio decreased with respect to the as-received sample to 1.754, the MER to 0.199, and the Grade Potential increased to 27.37% P_2O_5 .

As established in Item 13, the process at the Wash Plant can liberate and reject the impurities to the -325-mesh size fraction (-44 μm). Thus, these results are encouraging, and they indicate, that by using the Wash Plant additional unit operations, and taking advantage of the characteristics of H1 and NDR Phosphate Ores it may be possible to fulfill the specifications required to feed phosphate rock to the PAP at >30% P_2O_5 , <0.60% MgO , and about 10% SiO_2 .

Table 17-2 shows the chemical analysis of RVM LOI#2 and LOI#3 composite to simulate H1 Phosphate Ore. The data shown in Table 17-2 for the components of the composite model of H1 Phosphate Ore corresponds to RVM LOI#2 and LOI#3 combined in a 1:2 proportion. LOI#2 analyzed 21.70% P_2O_5 with 3.00% Al_2O_3 , 2.00% MgO , 1.30% Fe_2O_3 , and 17.50% SiO_2 . This phosphate ore shows parameters that indicate the presence of both calcite and dolomite with CaO/P_2O_5 Ratio of 1.654. This includes a significant amount of impurities such as aluminum silicates, clays, dolomite, and iron bearing minerals with a MER of 0.290 and the presence of high SiO_2 that results in a Grade Potential of 28.48% P_2O_5 . LOI#3 ore contains 25.10% P_2O_5 with 2.40% Al_2O_3 , 1.40% MgO , 0.74% Fe_2O_3 , and 12.90% SiO_2 , resulting in a lower CaO/P_2O_5 Ratio of 1.585, but still with the presence of calcite and dolomite. Impurities of aluminum silicates, clays, dolomite, and iron bearing minerals are significantly decreased, as indicated by a MER of 0.188. Since SiO_2 decreases to 12.90%, the Grade Potential increases to 30.40% P_2O_5 .

The composite used as model of H1, resulted in a phosphate ore of 23.77% P_2O_5 with 2.60% Al_2O_3 , 1.60% MgO , 0.93% Fe_2O_3 , and 14.43% SiO_2 . Since the blend contained a 1:2 ratio of LOI#2 to LOI#3, the evaluation parameters were a CaO/P_2O_5 Ratio of 1.606, a MER of 0.214, and a Grade Potential of 29.80% P_2O_5 . The composite without the 400-mesh size fraction (-38 μm) shows an increase in the quality of the material, analyzing 25.62% P_2O_5 with 2.10% Al_2O_3 , 1.55% MgO , 0.68% Fe_2O_3 , and 11.79% SiO_2 . This resulted in parameters, CaO/P_2O_5 Ratio of 1.598, MER of 0.163, and Grade Potential of 30.54% P_2O_5 . These results were obtained by crushing to about 0.3125 inch (-8000 μm), but without any scrubbing, as it will be in the Wash Plant.

Table 17-2: Chemical Analysis of Rasmussen Valley Mine LOI#2 and LOI#3 Model for H1 and Composites

Sample	Grades						Parameters		
	P ₂ O ₅ , %	CaO, %	Al ₂ O ₃ , %	MgO, %	Fe ₂ O ₃ , %	SiO ₂ , %	CaO/P ₂ O ₅ Ratio	MER	Grade Potential
LOI#2	21.70	35.90	3.00	2.00	1.30	17.50	1.654	0.290	28.48
LOI#3	25.10	39.80	2.40	1.40	0.74	12.90	1.585	0.188	30.40
Composite	23.97	38.50	2.60	1.60	0.93	14.43	1.606	0.214	29.80
Composite (+38 µm)	25.62	40.75	2.10	1.55	0.68	11.79	1.598	0.169	30.54

Screen Assays

To determine the fate of impurities in the H1 Phosphate Ore, screen assays were performed after preparing the material to -0.75 inch (-19,050 µm). Table 17-3 shows that impurities trended to report in the -325-mesh size fraction (-44 µm), even without scrubbing, or grinding. This size fraction corresponds to a 17.54% wt. (yield), resulting in the rejection of material containing 15.82% P₂O₅, 4.66% Al₂O₃, 1.33% MgO, and 25.79% SiO₂, which is equivalent to distribution contents of 11.00 % of P₂O₅, 35.35% of Al₂O₃, 32.60% MgO, and 34.06% SiO₂ respectively. Thus, Composite 1 was analyzed as having 27.51% P₂O₅ with 1.75% Al₂O₃, 0.59% MgO, and 10.62% SiO₂ with a recovery of 89.00% wt. of P₂O₅ content. Therefore, unit operations, such as scrubbing and grinding may result in a product fulfilling the product specifications (>30% P₂O₅, <0.60% MgO, and about 10% SiO₂) by beneficiating the H1 Phosphate Ore in the current Wash Plant.

Table 17-3: Screen Assay of H1 Composite 1, >20% P₂O₅¹

Fraction µm	Weight g	Weight %	Grades				Distribution			
			P ₂ O ₅ , %	Al ₂ O ₃ , %	MgO, %	SiO ₂ , %	P ₂ O ₅ , %	Al ₂ O ₃ , %	MgO, %	SiO ₂ , %
+300	56.77	22.88	28.30	1.69	0.53	9.99	25.43	17.05	16.84	17.21
300x212	49.13	19.79	28.20	1.62	0.50	9.71	21.92	14.14	13.74	14.47
212x150	34.96	14.09	28.00	1.68	0.53	9.84	15.50	10.44	10.37	10.44
150x53	58.43	23.54	26.40	1.88	0.72	11.70	24.41	19.52	23.54	20.74
53x44	5.36	2.16	21.60	2.62	0.97	18.90	1.83	2.50	2.91	3.08
44x20	17.57	7.08	17.60	3.38	1.14	25.90	4.89	10.56	11.21	13.81
20x10	10.00	4.03	15.20	4.62	1.46	27.00	2.41	8.21	8.17	8.19
-10	15.96	6.43	14.30	6.20	1.48	24.90	3.61	17.58	13.22	12.06
Calc. Head	248.18	100.00	25.46	2.27	0.72	13.28	100.00	100.00	100.00	100.00

H1 Composite 1+2, >20% P₂O₅ resulted from a 1:1 combination of Composite 1, >20% P₂O₅ and Composite 2, <20% P₂O₅. This calculated composite shows the effect of including high MgO areas of H1 deposit at a very high ratio. The reader should be aware that this composite does not reflect the projected ore feed from mine planning. Thus, the ratio for H1 Composite 1+2 should be considered as an extreme case. As in the case of H1 Composite 1, the screen assays performed corresponded to H1 Composite 1+2 prepared at -0.75 inch, (-19,050 µm), but without scrubbing, or grinding, as it will be submitted to in the Wash Plant.

The results for H1 Composite 1+2 are presented in Table 17-4. For these calculations, the same weight of the different size fractions as those for Composite 1, >20% P₂O₅ was considered, as reported by Albatross Environmental and Processing Consulting, Inc (SGS Laboratories, November 5, 2013, pp. 59). Under these high limit MgO content conditions, Table 17-4 shows that H1 Composite 1+2, >20% P₂O₅ crushed to -0.75 inch (-19,050 µm) without scrubbing, or grinding, rejected in the -325-mesh size fraction (-44 µm) material analyzing 13.52% P₂O₅ with 4.70% Al₂O₃, 2.13% MgO, and 25.34% SiO₂ corresponding respectively to the rejection of 10.96% of P₂O₅ content, 31.33% of Al₂O₃, 22.47% of MgO, and 29.35% of SiO₂. The estimated +325-mesh material was analyzed to contain 22.65% P₂O₅, 2.19% Al₂O₃, 1.51% MgO, and 12.97% SiO₂, recovering 90.04% of the P₂O₅ content. Even though these results were not close to the desired specifications (>30% P₂O₅, <0.60% MgO, and about 10% SiO₂), this data indicates that the contaminants trended to be reported in the -325-mesh

size fraction (-44 µm) with low P₂O₅ losses. Clearly, H1 Phosphate Ore submitted to scrubbing and grinding in the Wash Plant may result in a better product. Moreover, modifications of the Wash Plant (see Item 26 Recommendations–Metallurgy) may render a beneficiation product and/or a selected size fractions at specifications with the remaining material providing a good flotation feed.

Table 17-4: Screen Assay of H1 Composite 1+2 >20% P₂O₅

Fraction µm	Weight g	Weight %	Grades				Distribution			
			P ₂ O ₅ , %	Al ₂ O ₃ , %	MgO, %	SiO ₂ , %	P ₂ O ₅ , %	Al ₂ O ₃ , %	MgO, %	SiO ₂ , %
+300	56.77	22.88	23.55	2.02	1.52	11.84	25.69	17.56	21.40	17.89
300x212	49.13	19.79	22.85	2.16	1.44	12.66	21.56	16.24	17.54	16.55
212x150	34.96	14.09	23.10	2.16	1.42	12.32	15.52	11.56	12.31	11.46
150x53	58.43	23.54	21.80	2.34	1.60	14.05	24.47	20.93	23.18	21.84
53x44	5.36	2.16	17.50	2.90	1.90	20.40	1.80	2.38	2.53	2.91
44x20	17.57	7.08	14.40	3.58	2.05	26.05	4.86	9.63	8.93	12.18
20x10	10.00	4.03	12.46	4.62	2.31	26.45	2.39	7.07	5.73	7.04
-10	15.96	6.43	12.12	5.99	2.10	23.85	3.71	14.63	8.31	10.13
Calc. Head	248.18	100.00	20.98	2.63	1.62	15.14	100.00	100.00	100.00	100.00

In the case of the RVM LOI #2 and LOI #3 Composite Model of H1 Phosphate Ore, the material was crushed to -0.3125 inch (-8000 µm) without any scrubbing or grinding. The screen assay is presented in Table 17-5. This table shows that material reporting to the 48 x 200-mesh size fraction (600x75 µm) was at specification and corresponding to 15.3% wt. (yield) of this material, analyzing 30.86% P₂O₅ with 1.23% Al₂O₃, 0.61% MgO, and 7.57% SiO₂. The distribution respectively reported 19.99% of P₂O₅ content, 7.73% of Al₂O₃, 4.77% of MgO, and 7.45% of SiO₂.

The data shown in Table 17-5 also indicates that impurities, such as dolomite, aluminum silicates, clays, and silica tend to report to the -200-mesh size fraction (-75 µm) whereas the P₂O₅ content decreases toward the finer size fractions. Besides the 15.3% wt. of material at specs, it is important to highlight that only 7.12% of P₂O₅ content reports to the -200 mesh (-75 µm), but 32.52% of the Al₂O₃, 14.2% of MgO, and 30.02% of SiO₂ reports to this size fraction, the -200-mesh size fraction (-75 µm), analyzing 12.23% P₂O₅, 5.76% Al₂O₃, 2.03% MgO, and 33.86% SiO₂. On the other hand, 86.3% of the material reports in the +200 mesh (+75 µm), corresponding to a recovery of 92.88% of the P₂O₅ content, 67.48% of Al₂O₃, 85.80% of MgO, and 69.98% of the SiO₂, analyzing 26.33% P₂O₅ with 1.90% Al₂O₃, 1.95% MgO, and 12.60% SiO₂. Moreover, 15.3% wt. of the material is already at product specification levels (>30% P₂O₅, <0.60% MgO, and about 10% SiO₂), corresponding to 19.90% of the P₂O₅ content, as mentioned before. Again, the appropriate operating conditions and type of scrubbing, crushing, and grinding unit operations may result in a beneficiated product at specifications with high P₂O₅ recovery.

Table 17-5: Screen Assay of Blend Feed of RVM as H1 Phosphate Ore Model⁴

Fraction µm	Weight %	Pass. Wt. %	Grades				Distribution			
			P ₂ O ₅ , %	Al ₂ O ₃ , %	MgO, %	SiO ₂ , %	P ₂ O ₅ , %	Al ₂ O ₃ , %	MgO, %	SiO ₂ , %
8000x3327	53.00	47.00	23.60	2.00	2.50	14.00	53.06	43.62	67.56	47.89
3327x2800	2.70	44.30	25.80	2.10	1.70	13.00	2.91	2.30	2.30	2.23
2800x1700	7.50	36.80	25.30	2.60	1.60	13.70	8.05	8.02	6.12	6.63
1700x1200	2.60	32.20	25.90	1.90	1.50	12.40	2.84	2.02	1.98	2.07
1200x850	2.80	31.40	26.40	2.00	1.30	12.10	3.16	2.32	1.87	2.20
850x600	2.40	29.00	28.80	1.50	1.00	9.80	2.87	1.45	1.20	1.49
600x300	5.00	22.00	31.00	1.20	0.66	7.10	6.53	2.45	1.67	2.28
300x150	5.10	18.90	31.40	1.20	0.47	6.70	6.79	2.52	1.22	2.20
150x75	5.20	13.70	30.20	1.30	0.71	8.90	6.67	2.78	1.88	2.99
75x53	1.70	12.00	23.00	1.90	1.80	18.00	1.64	1.31	1.54	1.95
53x38	1.40	10.60	16.00	2.60	2.50	31.60	0.98	1.55	1.85	2.96
-38	10.60	0.00	10.00	6.80	2.00	36.70	4.50	29.66	10.81	25.11
Calc. Head	100.00	--	23.59	2.43	1.96	15.51	100.00	100.00	100.00	100.00

In general, all the screen assays results suggest that the Wash Plant with appropriate modifications may be able to produce a beneficiated product at the required specifications using H1 Phosphate Ore.

Mineralogical Studies

Mineralogical studies were carried out at SGS, Lakefield, Canada (SGS Laboratories, November 5, 2013, pp. 59), to determine the mineral speciation and liberation states. For this purpose, H1 Composite 1, >20% P₂O₅, and H1 Composite 2, <20% P₂O₅ samples were prepared by homogenizing the sample, crushing it to -0.75 inch (-19,050 µm), further crushing to 80% passing 10 mesh (-1,651 µm), and sieving into eight size fractions including +300 µm, 300x212 µm, 212x150 µm, 150x53 µm, 53x45 µm, 45x20 µm, 20x10 µm, and -10 µm. These size fractions were submitted to QEMSCAN and Electron Microprobe Analyzer (EMPA) without scrubbing.

The H1 Composite 1, >20% P₂O₅ study reported that the most abundant mineral was apatite (65.30% wt.) followed by impure apatite (12.60% wt.), quartz (5.70% wt.), micas (5.00% wt.), and calcite (4.79% wt.). The liberation studies show that apatite was very liberated in all size fractions, with an average of >85% of total free apatite and total liberated apatite. The results of the liberation studies are presented in Table 17-6.

Table 17-6: Apatite Liberation Studies for H1 Composite 1, >20% P₂O₅

Size Fraction µm	Locked Apatite Total, %	Submidd. Apatite Total, %	Middling Apatite Total, %	Liberated Apatite Total, %	Free Apatite Total, %	Liberated + Free Total Apatite, %
+300	0.34	1.48	9.26	29.70	59.20	88.90
300x212	0.38	1.86	9.14	24.00	64.60	88.60
212x150	0.35	1.73	8.55	25.40	64.00	89.40
150x53	0.40	1.81	7.51	19.50	70.80	90.30
53x44	0.84	2.68	6.70	12.50	77.20	89.70
44x20	1.00	3.04	6.58	10.60	78.80	89.40
20x10	1.11	4.16	7.56	8.61	78.80	87.41
-10	0.90	4.32	9.88	8.72	76.20	84.92
Combined	0.45	1.98	8.51	22.50	66.60	89.10

The QEMSCAN calculates a theoretical P₂O₅ recovery and its corresponding P₂O₅ product grade that could be produced using beneficiation techniques, but without considering processing technology inefficiencies and flowsheet efficiencies. From these theoretical Grade-Recovery Curves, it was estimated that a 35% P₂O₅ beneficiated product grade and a 90% P₂O₅ recovery could be obtained. Several options were also presented, such as 30% P₂O₅ grade and a 100% P₂O₅ recovery, 32% P₂O₅ grade and a 98% P₂O₅ recovery, 34% P₂O₅ grade and a 94% P₂O₅ recovery, and 36% P₂O₅ grade and a 88% P₂O₅ recovery.

A similar evaluation was performed for H1 Composite 2, <20% P₂O₅. With this information, and assuming a 1:1 ratio of Composite 1 to Composite 2, results were calculated for H1 Composite 1+2, >20% P₂O₅ and presented in Table 17-7.

Again, the most abundant mineral was apatite (52.2% wt.) followed by impure apatite (11.6% wt.), calcite (10.0% wt.), quartz (6.6% wt.), and micas/clays (6.2% wt.). The liberation studies showed that liberation of apatite was >80% for all size fractions studied as Liberated and Free Total Apatite. The QEMSCAN theoretical calculation of Grade-Recovery Curves estimated that it could be possible to obtain a 35.0% P₂O₅ beneficiated product grade at 84.0% of P₂O₅ recovery. Other potential combination of grade-recovery included 30.0% P₂O₅ product grade at a 98.5% P₂O₅ recovery, 31.5% P₂O₅ grade at a 95.0% P₂O₅ recovery, 33.5% P₂O₅ grade at a 89.0% P₂O₅ recovery, and 35.5% P₂O₅ grade at a 83.0% P₂O₅ recovery.

Table 17-7: Apatite Liberation Studies for H1 Composite 1+2, >20% P₂O₅

Size Fraction µm	Locked Apatite Total, %	Submidd. Apatite Total, %	Middling Apatite Total, %	Liberated Apatite Total, %	Free Apatite Total, %	Liberated + Free Total Apatite, %
+300	1.67	5.16	13.28	28.25	51.65	79.90
300x212	1.62	4.81	13.22	25.40	54.95	80.35
212x150	1.38	4.30	11.18	26.45	56.70	83.15
150x53	1.14	3.09	9.46	20.10	66.25	86.35
53x44	1.50	3.88	8.45	13.35	72.80	86.15
44x20	1.72	4.20	8.07	10.95	75.05	86.00
20x10	1.68	5.28	9.18	9.10	74.90	84.00
-10	1.27	5.84	11.69	8.80	72.40	81.20
Combined	1.46	4.44	11.50	22.70	59.90	82.60

The mineralogical and liberation studies indicate that apatite was liberated, and that unit operations, such as scrubbing and grinding, may selectively reduce the particle size of softer impurities than the phosphate mineral, such as dolomite, aluminum silicates, clays, iron bearing minerals, and silica containing minerals. Quartz, harder than phosphate, was the exception, but its content was lower than 6.6%. Therefore, SiO₂ chemical analyses showing high grades of SiO₂ in the fine fractions (see Item 13.2.2 Washer Plant Feed - Screen Assays), which may be mainly due to silicates.

These mineralogical studies are confirmed by the chemical analysis and the screen assays characterization studies. They indicate that it is possible to beneficiate H1 and NDR in the Wash Plant. Some modifications may be necessary in the operating conditions and/or with the addition of other unit operations, such as selective crushing using bed-comminution mechanisms, attrition scrubbing, sizing and classification, and flotation of the appropriate streams, if required.

Conda Washer Plant and Modifications

Based on the characterization studies performed for H1 as well as the model of H1 Phosphate Ore using RVM LOI#2 and LOI#3, the description of the Modified Conda Wash Plant includes the potential modifications for the successful use of plant to obtain a beneficiated product that fulfills the required specifications of >30% P₂O₅, < 0.60% MgO, and about 10% SiO₂.

The Modified Wash Plant is depicted in Figure 17-3. The H1 and NDR Phosphate Ores will use the same reception system of CPP for the phosphate ore. It is expected that the plant will receive a partially blended phosphate ore of four qualities, ROM, B+, High MgO, and High Al. Each of these types of ore will be hauled from the mines to the Wash Plant by unit trains loaded with a defined type of phosphate ore. Each car will be unloaded with the “rollover” system and will be sampled to check the quality of the phosphate ore. Then, it will be directed to the corresponding stockpiles of ROM, B+, High MgO, and High Al, using belt conveyors and stackers. Dozers, or front-end loaders will be used to build and maintain the inventory stockpiles as well as to reclaim the ore from each stockpile to prepare a blended feed with the different phosphate ores for the Feeding Hopper of the Wash Plant. Then, the blended phosphate ore will be screened over an 8-inch screen, with the +8-inch material returning to the stockpiles, and the -8-inch phosphate ore feeds the wash plant.

The screened phosphate ore of H1 and NDR will be fed through a belt conveyor where the ore is sampled for moisture, and sent to the Chemical Laboratory to be submitted to chemical analysis, and simulate the performance of the Wash Plant. The feed rate is kept at an average of 350 tph (dry) to the 10 ft x12-ft Horizontal Scrubber. Here, H1 and/or NDR Phosphate ore will be slurried, using recycled water from the Tailings Pond and the dewatering cyclones. The operating conditions of the Horizontal Scrubber will be optimized for these phosphate ores to maximize the cleaning of the surfaces of the fluorapatite or hydroxy-apatite of H1 and/or NDR of attached impurities (slimes), weak inclusions, and break aggregates of clayish material (see Item 26 Recommendations-Metallurgy). At this stage, impure fluorapatite or hydroxy-apatite of these ores will not be liberated of impurities. The discharge of the horizontal scrubber will be sized using a trommel to separate valuable phosphate from contaminants. This trommel will consist of two concentric screens of 0.25 inch (6,350 µm) and 1.375 inch (34,925 µm). The -0.25-inch size fraction (-6,350 µm) will be directed to classification, the 1.375x0.25-inch material (34,925x6,350 µm) will be sent to the washer's rod mill, and the 8x1.375-inch size fraction (203,200x34,925 µm) will be sent to the existing impact crusher, working in open circuit with the horizontal scrubber.

At this point, the first Wash Plant modification considered would be the replacement of the current impact crusher by a high pressure grinding roll (HPGR) to apply selective grinding of impurities through the use of a bed-comminution mechanism. According to the characterization studies and grinding tests performed^(1,2, 3), the fluorapatite or hydroxy-apatite is harder than the impurity minerals, while the overall H1 ore is considered soft. This may allow for the liberation of the phosphate mineral and impure apatite at the coarsest size fraction possible from dolomite, aluminum silicates, clays, quartz, and iron bearing minerals.

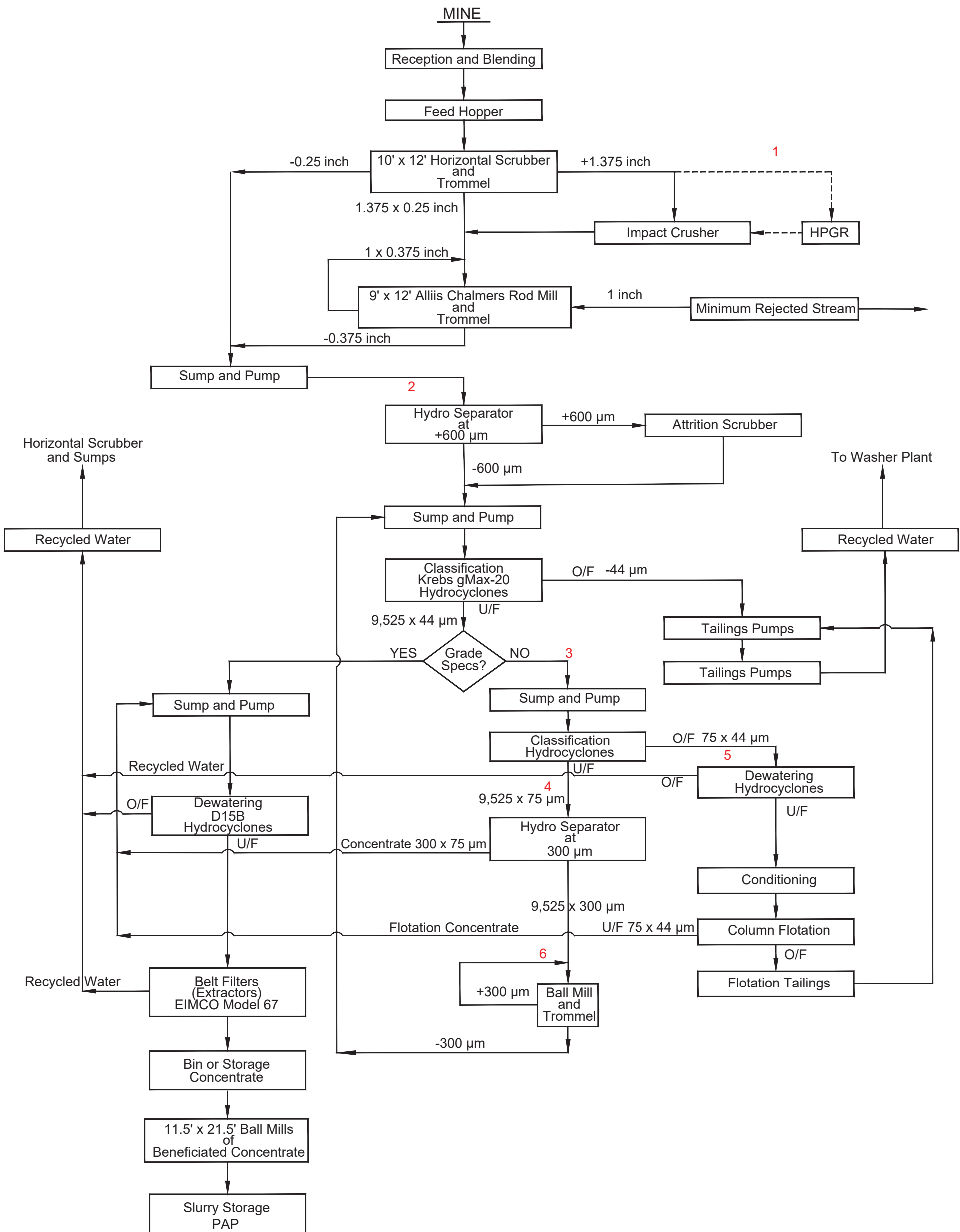

CLIENT		ITAFOS CONDA LLC	
PROJECT		NI 43-101 TECHNICAL REPORT FOR CONDA PHOSPHATE OPERATIONS	
TITLE			
BENEFICIATION PLANT FLOWSHEET			
CONSULTANT		YYYY-MM-DD	2019-11-20
		PREPARED	WJS
		DESIGN	MO
		REVIEW	MO
		APPROVED	MO
PROJECT NO.	PHASE	Rev	FIGURE
18114499	0001	A	17-3

REFERENCE(S)
 1.) SOURCE: ITAFOS CONDA LLC

The crushed product will join the 1.375 x 0.25-inch size fraction (34,925 x 6,350 μm) to feed the rod mill for further size reduction to -0.375 inch (-9,525 μm) and liberation of impure fluor-apatite or hydroxy-apatite from contaminants. The 9-ft x 12-ft Allis Chalmers Rod Mill will be only loaded with 4-inch diameter rods to avoid over-grinding; the ground product will be sized in a trommel screen attached to the rod mill. This trommel will consist of two concentric screens of 0.375 inch (9,525 μm) and 1-inch (25,400 μm) openings, which produce minimum +1-inch rejects (+25,400 μm), a 1 x 0.375-inch material (25,400x9,525 μm), that will return to the rod mill as circulating load, with the -0.375-inch size fraction (-9,525 μm), joining the -0.25-inch material (minus 6,350 μm) to be submitted to classification. Under the conditions used for grinding to reduce losses of P_2O_5 in the tailings stream, the production of phosphate ore finer than 325-mesh size fraction (-44 μm) will be limited.

The characterization studies in the absence of scrubbing indicate that +325-mesh material (+44 μm) for H1 Composite 1, >20% P_2O_5 was almost reaching specifications (>30% P_2O_5 , <0.60% MgO, and about 10% SiO_2); as the H1 Composite 1+2, >20% P_2O_5 has significantly lower impurities grades in the +325-mesh size fraction (+44 μm); and that the RVM LOI#2 and LOI#3 Composite Model show product-level grades in the 28x200-mesh size fraction (600x75 μm). Therefore, a second modification to the Conda Wash Plant was considered as follows. The first stage of classification will consist of hydro separators. The combined -0.25 inch (-6,350 μm) and -0.375-inch material (-9,525 μm) will be pumped to hydro separators with a cutting mesh of 28 mesh (600 μm). The overflow of the hydro separators (-28 mesh, or minus 600 μm) will be sent to a second stage of classification, using the Krebs gMax-20 Hydrocyclones whereas, the underflow of hydro separators (+28 mesh or +600 μm) will be sent to attrition scrubbing (under optimum operating conditions) to obtain the maximum efficiency on cleaning the surfaces of the phosphate mineral particles. These operating conditions will need to be precisely determined (see Item 26 Recommendation-Metallurgy). The attrition scrubbed underflow of the hydro separators will be sent to the sump of the pump feeding the Krebs gMax-20 Hydrocyclones nest of five units. These gMax-20 Hydrocyclones will have a cutting mesh of 325 mesh or 44 μm . Thus, this second classification stage will separate the enriched phosphate ore at 0.375 inch x 325-mesh size fraction (9,525x44 μm) from the -325-mesh material (-44 μm) that contains impurities, such as dolomite, quartz, aluminum silicates, clays, and iron bearing minerals. The overflow of three Krebs gMax-20 Hydrocyclones in operation will constitute final tailings, which will then be pumped to the Tailings Pond.

The underflow (0.375inch x 325-mesh material or 9,525x44 μm) of these operating Krebs gMax-20 Hydrocyclones is expected to achieve the beneficiated product specifications. In this case, this enriched phosphate ore will be discharged into a second sump where recycled water from the dewatering hydrocyclones will be added to be pumped to the dewatering unit operations.

Dewatering of the enriched 0.375-inch x 325-mesh H1 and/or NDR Phosphate Ores (9,525 x 44 μm) is performed in six Krebs D15B Hydrocyclones followed by filtration in two belt filters (extractors). The dewatering hydrocyclones will be arranged in two sets of three hydrocyclones each, with five in operation and one on standby. The overflow of these dewatering hydrocyclones will report low solids content, which is low enough to be recycled as makeup water by the water distribution system of the Wash Plant.

The underflow of these dewatering hydrocyclones will constitute the feed to the belt filters or extractors EIMCO Model 67, the cake produced will be stored in a bin or transferred by a reversible belt conveyor to a stockpile with a total storage capacity of 60,000 tons. The water obtained from the extractors will report to the water recycling system. A belt conveyor will reclaim the Wash Plant beneficiated concentrate from the bin, and dozers, or front-end loaders, from the stockpile to feed two open circuit ball mills running in parallel. The dozers, or front-end loaders, will feed a hopper that discharge in a system of belt conveyors to grind the Washed Plant product in one,

or both, FFE 11.5 ft x 21.5-ft Ball Mills. Here, the concentrate will be ground to 98% -35-mesh size fraction (-420 μm) to allow an acceptable recovery in the PAP. The slurry of the enriched H1, or NDR, Phosphate Ores produced will be stored in an agitated tank to be reclaimed, as needed, by the PAP.

In this scenario, a beneficiated product will be achieved by horizontal scrubbing, sizing, grinding, classification, and dewatering. The tailings (-325-mesh size fraction or -44 μm material) will be freely discharged to form a sand beach. The decanted water will be conducted to a deep-water area for recycling and the recovered-decanted water pumped to the Wash Plant.

The Metallurgical Balance for this case is presented in Table 17-8, which was estimated based on the characterization studies data. Since the screen assay reported were not scrubbed and ground, for estimating the yield of the concentrate, the 0.375 inch x 325 mesh (9,525x44 μm) beneficiated product will be obtained by calculating all material going to tailings: The screen assay of the H1 Composite 1+2, >20% P_2O_5 -325-mesh material; the rejected overflow of the Hydrofloat Flotation Cells both coarse (600x300 μm) of 5.7% yield, and fine (300x150 μm) of 3.2% yield; the overflow of the Cav-Tube Column Flotation Cell for fines, O/F MgO of 6.2% yield, and the O/F SiO_2 of 7.2% yield; and subtracting the 150x44 μm yield of 6.90% wt.

Table 17-8: Metallurgical Balance for H1 without Flotation

Product	Size Fraction, μm	Weight TPH	Weight %	Grades					Distribution				
				P_2O_5 , %	Al_2O_3 , %	MgO, %	Fe_2O_3 , %	SiO_2 , %	P_2O_5 , %	Al_2O_3 , %	MgO, %	Fe_2O_3 , %	SiO_2 , %
Concentrate	9525x44	242.27	67.06	30.34	0.59	0.56	0.31	8.35	84.88	15.22	23.47	22.35	38.80
Tailings	-44	107.73	32.94	11.00	6.69	3.72	2.19	26.81	15.12	84.78	76.53	77.65	61.20
Feed	--	350.00	100.00	23.97	2.60	1.60	0.93	14.43	10.00	100.00	100.00	100.00	100.00

Table 17-8 shows the tailings yield to be 32.94%, while the calculated yield for the 0.375 inch x 325 mesh (9,525x44 μm) product being 67.06% wt. It is assumed that the same feed grade used for the flotation tests (for consistency) and weighted average concentrate grade will be obtained. Thus, the beneficiated product analyzed 30.34% P_2O_5 with 0.59% Al_2O_3 , 0.56% MgO, 0.31% Fe_2O_3 , and 8.35% SiO_2 . The recovery was estimated at 84.88% of P_2O_5 content with the rejection of 84.77% of Al_2O_3 , 76.53% of MgO, 77.65% of Fe_2O_3 , and 61.20% of SiO_2 respectively.

Flotation Feed Preparation

In the case that the underflow of the Krebs gMax-20 Hydrocyclones (0.375 inch x 325-mesh size fraction or 9,525x44 μm) could not achieve the required product specifications (>30% P_2O_5 , <0.60% MgO, and about 10% SiO_2), flotation may be necessary. However, the characterization studies indicate that H1 Composite 1, >20% P_2O_5 and H1 Composite 1+2, >20% P_2O_5 after horizontal and attrition scrubbing and grinding could significantly reduce the contaminants for the +48-mesh size fraction (+300 μm). Moreover, the simulated H1 Phosphate Ore, using RVM LOI#2 and LOI#3, produces a concentrate at specifications for the 28 x 200-mesh size fraction (600x75 μm) without any scrubbing and grinding with +600 μm material being relatively low in contaminants. Consequently, the flotation feed preparation should consider an extra classification step by using hydrocyclones with a cutting mesh at 200 mesh (75 μm).

Thus, the 0.375-inch x 325-mesh size fraction (9,525 x 44 μm) of H1 and NDR could be pumped to a nest of hydrocyclones with a cutting mesh of 200 mesh (75 μm). The overflow consisting of 200 x 325-mesh material (75x44 μm) will be sent to fine flotation in columns while the underflow consisting of 0.375 inch x 200-mesh size fraction (9,525x75 μm) not at specifications will be sent to a hydro separator.

The hydro separator will be set for cutting at 48 mesh (300 μm). The underflow of the hydro separator will consist of +48-mesh material (+300 μm), and the overflow of the hydro separator 48x200-mesh size fraction (300x75 μm)

will constitute product, as indicated by the characterization studies. Since it is known that the 28 x 200-mesh material (600x75 µm) is already product (as indicated by the characterization studies), the 48 x 200-mesh size fraction (300x75 µm) will also be product. This product will then be sent to the dewatering stages.

In the case that the +48-mesh material (+300 µm) is out of specifications, this size fraction will be ground in a ball mill to -48 mesh (-300 µm). Here, the ball mill discharge will work with a 48 mesh (300 µm) trommel screen with the +48-mesh material (+300 µm) returning to the ball mill (circulating load). The -48 mesh (-300 µm) will be sent to the sump of the pump feeding the Krebs gMax-20 Hydrocyclones with a cutting mesh of 325 mesh (44 µm) and the -325 mesh (-44 µm) being tailings. Downstream from the classification Krebs gMax-20 Hydrocyclones, hydrocyclones cutting at 200 mesh (75 µm) and a hydro separator at 48 mesh (300 µm) will process the ground material, where the 48x200-mesh material (300x75 µm) will become product, and the 200 x 325 mesh (75x44 µm) will constitute the fine flotation feed.

Consequently, column flotation will be performed on a limited size fraction of the H1 and NDR Phosphates Ores which is the 200 x 325-mesh material (75x44 µm). This size fraction is ideal for column flotation cells.

Flotation

The flotation process is based on the Eriez Flotation Division/USA (Redacted Version), Final Report-Laboratory Testing. However, these studies were performed on a simulated H1 Phosphate Ore using RVM LOI #2 and LOI #3. Since previous reports (SGS Laboratories, November 5, 2013, pp. 59) presented the characterization study of H1 Phosphate Ore, this information was incorporated, and only the relevant data of the Eriez Flotation Division/USA Final Report was considered.

By combining the information obtained from these two reports, it was estimated that the 48 x 200-mesh material (300 x 75 µm) would fulfill the required product specifications of >30% P₂O₅, <0.60% MgO, and about 10% SiO₂. The minimum yield of the desired product could be estimated by calculating the tailings yield. To this purpose, the screen assay of H1 Composite 1+2, >20% P₂O₅, -325-mesh material (-44 µm), 17.54% wt. tailings yield; the rejected overflow of the Hydrofloat Flotation Cells both coarse (28x48 mesh or 600x300 µm) of 5.70% yield and the fine (48x100 mesh or 300x150 µm) of 3.20% yield; and the rejected overflow of the Cav-Tube Column Flotation Cell for fines both O/F MgO of 6.20% yield, and O/F SiO₂ of 7.20% yield were added. From this estimate, the 5.20% yield of the size fraction 100 x 200 mesh or 150x75 µm that reports in the product 48x200-mesh material (300 x 75 µm) was subtracted to obtain the tailings yield.

Thus, the tailings estimated yield is 34.64% wt., and the beneficiated product yield is 65.36% wt. The beneficiated product will consist of 44.96% yield of 48x200-mesh size fraction (300x75 µm) and 20.40% yield of the flotation concentrate of 200x325-mesh material (75x44 µm). Based on these estimates, the feed to the flotation cells would be 28.6% yield.

Based on the characterization studies, the Eriez flotation Division/USA Final Report, and the calculated estimate, the following metallurgical balance is presented in Table 17-9.

Table 17-9: Metallurgical Balance for H1 with Flotation

Product	Size Fraction, µm	Weight TPH	Weight %	Grades					Distribution				
				P ₂ O ₅ , %	Al ₂ O ₃ , %	MgO, %	Fe ₂ O ₃ , %	SiO ₂ , %	P ₂ O ₅ , %	Al ₂ O ₃ , %	MgO, %	Fe ₂ O ₃ , %	SiO ₂ , %
Coarse Con.	300x75	157.36	44.96	30.86	1.23	0.61	0.37	7.57	57.88	21.27	17.14	17.89	23.58
Fine Con.	75x44	71.40	20.40	29.42	0.64	0.45	0.33	9.77	25.04	5.02	5.74	7.24	13.81
Total Con.	300x44	228.76	65.36	30.41	1.05	0.56	0.36	8.26	82.92	26.29	22.98	25.13	37.39
Tailings	-44	121.24	34.64	11.82	5.53	3.56	2.01	26.08	17.08	73.71	77.12	74.87	62.61
Feed	--	350.00	100.00	23.97	2.60	1.60	0.93	14.43	10.00	100.00	100.00	100.00	100.00

The results using the Coarse Concentrate of 28 x 200-mesh size fraction (300 x 75 µm) and flotation of the 200 x 325-mesh material (75x44-µm) could result in a beneficiated product at specifications of 30.41% P₂O₅ with 1.05% Al₂O₃, 0.56% MgO, 0.36% Fe₂O₃, and 8.26% SiO₂. The recovery is estimated to be 82.92% of the P₂O₅ content with the rejection of 73.71% of Al₂O₃, 77.12% of MgO, 74.87% of Fe₂O₃, and 62.61% of SiO₂ respectively. The results with flotation compared to those without flotation show a slightly higher grade in P₂O₅ than that obtained without flotation (30.34% P₂O₅), but higher Al₂O₃ (0.59%), same MgO, lower Fe₂O₃ (0.31%), and lower SiO₂ (8.35%). Additionally, the recovery of P₂O₅ content is lower with flotation by 1.96%, with the rejection of impurities being similar.

Flowsheet with Modifications

Figure 17-3 presents the different options for the modification of the Conda Wash Plant to beneficiate H1 and NDR Phosphate Ores. The modifications will require conducting the studies considered in Item 26, Recommendations-Metallurgy. Based on the results of these studies, a final-defined flowsheet and the new operating conditions will be obtained.

The modifications are expected to include the following:

1. High pressure grinding roll (HPGR).
2. Hydro separator cutting at 28 mesh (600 µm).
3. Classification using hydrocyclones cutting at 200 mesh (75 µm).
4. Hydro separator cutting at 48 mesh (300 µm).
5. Dewatering hydrocyclones and flotation Columns of the size fraction 200x325 mesh (75x44 µm).
6. Grinding in a ball mill the +48 mesh (+300 µm).

CAPEX Estimates

The CAPEX cost estimate is presented in Table 17-10 and shows that the cost will change depending on the final pieces of equipment to be added to the Wash Plant, which will be defined upon performing the metallurgical recommendations (see Item 26). CAPEX does not include taxes, tariffs, duties, and so forth, nor spare parts, concrete bases, or Programmable Logic Controllers (PLCs).

Table 17-10: CAPEX Estimates +/-50% Level

Flowsheet Modification	Equipment	CAPEX \$	Observations
1	HPGR	1,650,000	To be decided (TBD), considered if needed, studies.
2	Hydro separator cutting at 28 mesh	515,000	Including Installation.
	Attrition Scrubbing	650,000	Including Installation.
3	Sump and Pump	250,000	Including Installation.
	Hydrocyclones cutting at 200 mesh	125,000	Including Installation.
4	Hydro Separator cutting at 48 mesh	515,000	Including Installation.
5	Dewatering Hydrocyclones	125,000	Including Installation.
	Cav-Tube Flotaion Columns	650,000	Based on Eriez Report.
6	Ball mill for 250 tph, -48 mesh product	5,500,000	TBD, Installation and accessories included.
	Piping, Connection, cabling & switches	200,000	For Installations.
	Total	10,180,000	

Conclusions

The following conclusions are offered in regard to this Item:

- The CPP Wash Plant could be used for H1 and NDR Phosphate Ores with modifications after carrying out the corresponding studies (see Item 26 Recommendations-Metallurgy).
- The CAPEX required is estimated to be about US\$10,180,000.
- Flotation may be required on a limited basis for the 200 x 325-mesh size fraction (75x44 µm).
- The product could be of two qualities both achieving the required specifications, depending on the characteristics of the ore:
 - Without flotation: 30.34% P₂O₅, 0.59% Al₂O₃, 0.56% MgO, 0.31% Fe₂O₃, and 8.35% SiO₂. Recovery: 84.88% of P₂O₅; Rejections: 84.78% of Al₂O₃, 76.33% of MgO, 77.65% of Fe₂O₃, and 61.20% of SiO₂.
 - With flotation: 30.41% P₂O₅, 1.05% Al₂O₃, 0.56% MgO, 0.36% Fe₂O₃, and 8.26% SiO₂. Recovery: 82.92% P₂O₅; Rejections: 73.71% Al₂O₃, 77.12% MgO, 74.87% Fe₂O₃, and 62.61% SiO₂.
- Metallurgical studies for H1 and NDR need to be conducted.

18.0 PROJECT INFRASTRUCTURE

This Item provides a summary of infrastructure and logistic requirements for the RVM and LCM projects. Infrastructure for the current operations is in place and adequate for the duration of mining. Key items of infrastructure are as follows.

Public site access is provided by State Highway 34 up to the WV Tipple and Ore Stockpile Area. Beyond the WV Tipple, a 14-mile long purpose-built mine haul road connects the WV Tipple to the RVM and LCM mining operations.

Electric power is supplied to the WV Tipple from the local grid via an incoming 46-kv transmission line. Power for the RVM and LCM sites is supplied by diesel generators.

The RVM mine office/shop facilities are located on the main haul road between the WV Tipple and the RVM and include the following:

- Four equipment maintenance bays
- Lubricant storage room
- Mine office that includes a conference room, break room, male and female locker rooms, shop office, and warehouse
- Analytical laboratory

Fuel farm storage capacity in support of the RVM and LCM operations consists of approximately 40,000 gallons of diesel, 3,000 gallons gasoline and 5,000 gallons of used oil.

Explosives storage for prill, emulsion, detonators, and caps sufficient to support the operation.

Other constructed building and facilities include the following:

- Cinder storage shed
- Wash bay
- Mining contractor's office.
- Main survey base station
- Equipment parts storage area
- 1,800 square foot (ft²) cement pad for changing haul truck tires
- Water stand

The RVM and LCM operations are connected to the CPP and outside services by telephone lines and fiber optic computer networking. All pits have two-way radio equipment, including repeaters and dedicated radio frequencies for communication between personnel and mobile equipment.

For both the RVM and LCM, topsoil is pre-stripped prior to mining. The topsoil stockpiles are placed around the perimeter of each pit.

Overburden Storage Area (OSA) backfill designs were completed for both RVM and LCM. Overburden from LCM is currently being backfilled into the mined-out phases of the LCM pit. The overburden from Phase 1 of RVM is currently being placed in the mined-out SRM pit, which was previously mined as part of Bayer's operations. To comply with the Mining and Reclamation Plan (MRP), all overburden will be backfilled into mined-out pits. Periodically, a portion of the overburden will require temporary over-stacking both within and outside the pit limit. The over-stacked locations and quantities were identified by Golder as part of the mine plan. To optimize over-stacking requirements over the near term, the RVM overburden will be placed into the LCM. At the end of the mine life, both overburden from the temporary over-stacked areas and the existing LCM OSAs will be re-handled into the final phase of the RVM.

Water management BMPs and sediment ponds are strategically located to control surface water from the RVM, LCM, and WV Tipple operations. These ponds are also used as a source of dust control water for the mining and tipple operations.

The WV Tipple is located 10.5 miles from RVM, 14.0 miles from LCM and 13.0 miles from the CPP. The Tipple is adjacent to a rail line that connects the mines to the CPP. The WV Tipple facility includes a forty-acre area for ore stockpiling and a reclaim and conveyor system with the capacity to load rail cars at a rate of 13 train cars per hour.

Rail transportation is provided by UPRR via approximately 13.0 miles of track connecting the WV Tipple to the CPP ore stockpile.

Figure 18-1 shows the locations of the key infrastructure described for the RVM and the LCM.

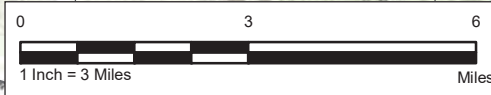
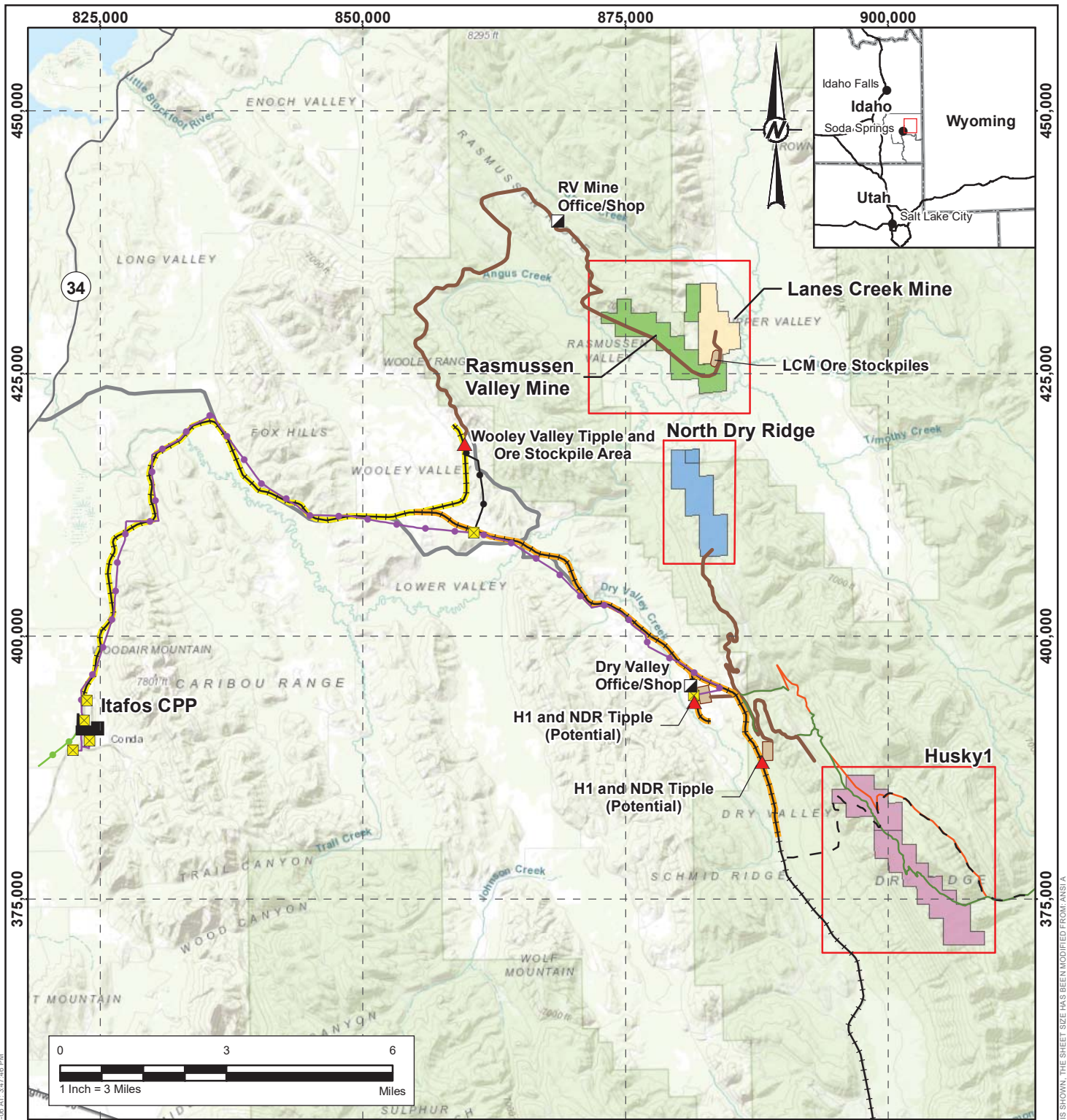

LEGEND

- Project Map Extents
- Ore Stockpile Area
- State Highway
- Haul Road
- Public Vehicle Access
- Existing Forest Service Road
- Road Realignment
- 12.5 kV Distribution Line
- 46 kV Transmission Line
- 138 kV Transmission Line
- Railroad - Existing
- Railroad - Existing to be Refurbished
- Buried Pipeline
- Itafos CPP
- Site Office/Shop
- Tipple
- Substation

REFERENCE(S)

1. COORDINATE SYSTEM: NAD 1983 STATE PLANE IDAHO EAST FIPS 1101 FEET
2. DATA PROVIDED BY ITAFOS CONDA LLC

CLIENT
ITAFOS CONDA LLC

PROJECT
NI 43-101 TECHNICAL REPORT FOR CONDA PHOSPHATE OPERATIONS

TITLE
EXISTING AND PLANNED INFRASTRUCTURE MAP

CONSULTANT	YYYY-MM-DD	2019-12-06
DESIGNED	-	
PREPARED	EFT	
REVIEWED	RM	
APPROVED	TM	



PROJECT NO.	CONTROL	REV.	FIGURE
18114499	0001	-	18-1

BATH: P:\Itafos - Conda - 18114499\GIS\Map\Final18-1_Infrastructure.mxd PRINTED ON: 2019-12-06 AT: 3:47:46 PM

1 in IF THIS MEASUREMENT DOES NOT MATCH WHAT IS SHOWN, THE SHEET SIZE HAS BEEN MODIFIED FROM: ANSIA

19.0 MARKET STUDIES AND CONTRACTS

19.1 CRU Market Study

A summary of reasonably available information is as follows concerning markets for Itafos' phosphate rock production. Itafos currently ships and plans to continue to ship all production from its mineral projects described in this report to the existing Itafos CPP near Soda Springs, Idaho. The mined phosphate ore will be beneficiated and processed into fertilizer products at the CPP. See Item 24.0 for additional information on the CPP.

All other phosphate ore produced in southeastern Idaho is similarly captive to vertically integrated fertilizer and phosphorous processing plants. For this reason, there are no transparent markets or commodity prices for southeastern Idaho phosphate rock. However, the Itafos CPP's demand and its ability to pay the cost of phosphate ore mined and transported from the Itafos mineral projects are dependent on the demand and prevailing commodity market prices for its fertilizer products, which consist of approximately 550 kt per year of specialty liquid and solid phosphates including monoammonium phosphate (MAP), superphosphoric acid (SPA), merchant grade phosphoric acid (MGA), and specialty products including ammonium polyphosphate (APP).

Itafos commissioned CRU Consulting, a division of CRU International Ltd. of London, UK to produce the Conda Phosphate Study (CRU Study) of the markets and forecast prices for the fertilizer products produced and shipped from the Itafos CPP. Due to its location in southeastern Idaho, the Itafos CPP serves North American fertilizer markets primarily west of the Mississippi River and in western Illinois. This market encompasses specialty agriculture growers of fruits, vegetables, and perennials of the western U.S., corn and soybean farmers of the American Midwest, and canola and wheat farmers of the Northern Plains of the U.S. and Canada.

SPA, MGA, and APP are sold to crop input retailers who re-sell to end users. Itafos is one of three key U.S. producers of SPA. All MAP production from the CPP is currently sold to Nutrien under a term sales contract that is due to expire in 2023.

The CRU study concludes that phosphate demand will grow slowly but steadily over the medium and long term, supporting demand for Itafos' fertilizer products. Relevant excerpts from the CRU Study are as follows. The QP added bracketed language for clarification or to remove irrelevant information.

"CRU's forecasts of increasing global consumption of agricultural production, both globally and in North America, establish a backdrop of price-supportive fundamentals for phosphate markets. This outlook for crop production translates to a P_2O_5 consumption forecast which is steadily increasing globally and mostly holding steady, with modest increases in North America.

Out of all mature consumption regions, we consider that North America has the most upside. It will continue to be a key exporter of soybean, canola and corn. Fertilizer efficiency per unit of agricultural production has improved significantly, but this has been in line with yield gains, meaning application rates have remained steady. P_2O_5 intensity of use, which measures the kg of nutrient per tonne of agricultural production, is expected to fall in North America over the long term due to this trend in rising fertilizer efficiency.

Global demand for phosphates is expected to grow [strongly]. This growth comes from gradual substitution from nitrogen-based fertilizers to phosphates due to changes in the global crop mix as well as policy shifts to balance the use of fertilizers in countries such as India.

Long term demand is set to grow at the highest rates in developing regions including Africa, South America, Eastern Europe, Southeast Asia and South Asia. Contrastingly, however, consumption growth in developed regions, namely in Eastern Asia, Western Europe and North America are forecast to remain subdued.¹

Although demand growth in North America is expected to be modest, the CRU Study forecasts strong increases in fertilizer product prices in North American markets. CRU's price forecast is based primarily on reductions in the capacity to supply North American markets. The forecast capacity reduction results in supply/demand balancing and is due to: CRU's forecast of strong international demand for fertilizer products coupled with reduced production and exports of fertilizer products from China, and lower MAP production capacity due to a plant closure and a plant conversion in Canada.

In the CRU Study, North American fertilizer product price forecasts are in real 2019\$ terms and are based on the following three fertilizer commodity bulk price benchmarks.

- DAP New Orleans, Louisiana (NOLA): The pricing basis is FOB barge New Orleans, Louisiana at the mouth of the Mississippi River from the US Gulf. Barges can be loaded from plants around the US Gulf and from oceangoing vessels discharging cargoes along the lower Mississippi River in Louisiana. DAP NOLA price indications assume that the barge shipment is loaded and begins delivery to customers at the river mouth. The main consumer markets are mostly US inland discharge points along the Mississippi River system.
- MAP Twin Cities: This FOB benchmark can be seen as a reference price for the Northern Plains. The pricing basis is FOB trucks/rail cars usually loaded from warehouses in the Minneapolis, St. Paul, Rosemont areas of Minnesota. Shipment sizes are 25-short ton trucks or 100-short ton rail cars.
- MAP Pacific Northwest: This benchmark represents a delivered price to distributors throughout Washington, Oregon and the Idaho panhandle.

The CRU Study states, "CRU's DAP FOB NOLA price forecast serves as a driver for the MAP price forecasts for the Twin Cities and Pacific Northwest benchmarks. We have selected these regional MAP benchmarks based on their status as key, accessible markets for [Itafos'] MAP production, and based on those US DAP and MAP price references that CRU publishes.

CRU projects long term US benchmark prices for DAP and MAP to increase in real terms, driven by escalating raw material and production costs."²

CRU also forecast prices for Itafos' SPA product:

"[P]rice forecasts for SPA [are] based on the realised Itafos SPA price, which is defined by Itafos as SPA revenues, net divided by sales volumes. This represents a composite price of its sales of SPA in different markets."... CRU and Itafos have mutually agreed for CRU to construct a price forecast for SPA based on market relationships provided specifically by Itafos. This established a historical average premium ... for delivered Western US SPA versus MAP NOLA.

CRU has derived a premium [for delivered western US SPA] over the MAP NOLA price by linking our historical MAP NOLA prices (as reported by [CRU's] Fertilizer Week [industry publication]) to

¹ (CRU, 2019), pp. 11-12.

² (CRU, 2019), p. 4.

our base case forecast for DAP NOLA, and a gradual reversion to the historical premium by 2021.”³

The CRU Study also contains estimated transportation costs to deliver MAP from the Itafos CPP to the Twin Cities and Pacific Northwest markets and resulting net-back MAP prices at the CPP.

The CRU price forecasts are based on the following key assumptions:

“[O]ur MAP Twin Cities and MAP Pacific Northwest price forecasts are linked to the DAP NOLA price via assumed premium levels based on historical analysis and CRU’s view of the market.”⁴

“CRU’s medium-term forecasts are cyclical, driven by foreseeable developments in the supply/demand balance and short run marginal costs (e.g. the production costs of Chinese producers). Beyond five years into the future, there exists greater degree of uncertainty in cyclical forecasts which necessitates an alternative long-term approach for price guidance.

In the longer term, markets are assumed to be self-correcting. Periods of high prices encourage producers to invest in additional capacity. Periods of low prices cut investment in the supply-side and may encourage additional consumption. Therefore, over the long term, prices trend towards an average level that is set by the industry’s fundamental supply characteristics.

Our main assumptions when assessing long-term pricing dynamics are threefold:

- Food consumption and economic growth will determine demand for fertilizers, while industrial productivity and technological development will provide the basis for non-agricultural demand.
- There is an implied supply gap based on our view of foreseeable capacity (existing supply and committed future supply) and the forecast of long-term demand.
- Supply will respond to this implied market scarcity and resulting price increases with new capacity investments, the operating and capital costs (Long Run Marginal Cost, or “LRMC”) of which will provide the basis for the price trend over the long run.”⁵

Risk factors related to CRU’s price forecasts are described in the CRU Study as follows.

“The following factors are not expected in our base case outlook but have the potential to move prices up or down, as detailed below.

Upside risk factors

- Brazilian phosphate rock mines experience prolonged production disruptions as a result of technical studies and actions and compliance with new regulations, for example in relation to new tailings dam regulations. Such delays would cause shortages of phosphate rock and MAP.

³ (CRU, 2019), p. 18.

⁴ (CRU, 2019), p. 14.

⁵ (CRU, 2019), p. 10.

- Ramp-up at Ma'aden's Wa'ad Al Shamal operation is slower than projected, constricting market supply.
- Greater than expected increases in raw material prices and long term cost drivers for production of phosphate fertilizers.

Downside risk factors

- The US planting season is weaker than expected, below CRU's already downward-revised outlook for 2019 on the back of Mississippi flooding and difficult weather. Long term increased occurrence of such weather events would weaken US fertilizer demand.
- Brazilian MAP import demand is weaker than expected, which would reduce some of the upward price pressure we are expecting in our base case view due to strength in the Brazilian market.
- Indian phosphate fertilizer subsidies turn out to be lower than expected, reducing affordability, demand and prices.
- Supply cuts by Chinese DAP producers, which are factored into our base case forecast, fail to materialise. Such a development could lead to surplus product in the Chinese and international markets, putting downward pressure on prices.
- Uncertain risk factors with potential upside and downside implications over the long term
 - Climate change and associated government policy
 - Farming technology innovations and agricultural productivity
 - Land and water resource constraints.”⁶

The CRU Study forecasts of MAP net-back prices and Itafos realized SPA prices are reproduced on Table 19-1. The forecasts are in real 2019\$ terms on a US\$/metric tonne basis.

⁶ (CRU, 2019), p. 15.

Table 19-1: Forecast Prices for MAP and SPA (Real 2019\$ terms)

Description	Units Year:	2019	2020	2021	2022	2023	2024	2025	2026	2027
MAP Price Netback Twin Cities to CPP	\$/mt	377	397	420	427	430	458	485	511	535
MAP Price Netback Pac. NW to CPP	\$/mt	453	461	470	477	480	509	536	562	587
Itafos Realised SPA Price	\$/mt	917	934	966	976	985	1,040	1,094	1,146	1,195
Description	Units Year:	2028	2029	2030	2031	2032	2033	2034	2035	2036
MAP Price Netback Twin Cities to CPP	\$/mt	559	581	603	609	616	624	633	642	646
MAP Price Netback Pac. NW to CPP	\$/mt	611	633	655	662	669	677	686	695	700
Itafos Realised SPA Price	\$/mt	1,242	1,286	1,329	1,342	1,357	1,373	1,390	1,409	1,418
Description	Units Year:	2037	2038	2039	2040	2041	2042	2043	2044	2045
MAP Price Netback Twin Cities to CPP	\$/mt	652	657	662	667	671	675	678	681	684
MAP Price Netback Pac. NW to CPP	\$/mt	706	712	717	722	726	730	733	737	740
Itafos Realised SPA Price	\$/mt	1,430	1,441	1,452	1,461	1,470	1,478	1,485	1,492	1,499

Source: CRU Study (CRU, 2019).

Fertilizer Product Costs and Margins

The CRU Study included estimated production costs for MAP and SPA in real 2019\$ for the year 2019 and for 2025 to show forecast cost escalation in real terms. The CRU Study states that the fertilizer product cost estimates were based on the following information and assumptions:

“The phosphate rock costs and phosphoric acid to SPA conversion costs are based on historical cost figures provided by Itafos and escalated by CRU.

The ex-rock, or plant, costs for phosphoric acid and MAP have been modeled with the CRU Phosphate Cost Model with some inputs provided by Itafos including:

- Beneficiated phosphate rock specifications
- Phosphate rock reactor consumption factor
- Labour rates and number of workers
- Electrical power rates and consumption
- Consumables

These costs, shown in real 2019\$ terms, indicate a forecast of modest real cost escalation ... driven by CRU projections for labour, power and supplies increasing at a rate slightly above general inflation. Our forecast for a moderately greater rate of increase in plant costs is driven by expectations of higher escalation for ammonia and sulfuric acid prices.

These cost estimates assume that phosphate rock mining and beneficiation, as well as the plant, continue to operate with the same steady-state processes and production levels from 2019 to 2025. However, by 2025 changes will likely impact the cost of mining, phosphate rock transport

and beneficiation. At the time of writing, we understand such changes are still being studied by Itafos. As a result, they have not been factored into the 2025 cost estimates.”⁷

The CRU Study concludes that:

”[...] with a 2019 MAP Pacific Northwest price of \$490/mt and [...] given our estimated costs, Conda has scope for positive margins. We note that this delivered MAP cost [...] does not detail the entirety of Conda’s economics and competitive position. This is in part due to a substantial portion of Conda’s profits being generated from sales of SPA [...].”⁸

The CRU Study also shows that based on the 2019 Itafos Realized SPA price of \$917/mt (\$832/st), Itafos earns a substantial margin on SPA sales.

The Qualified Person confirms that he has reviewed the CRU Study and analyses and that the results support the assumptions in the technical report.

19.2 Gross Margins Available for Mined Phosphate Ores

RVM and LCM are captive feedstock suppliers to the CPP, and there is no open commodities market in southeastern Idaho for mined phosphate ores. Therefore, for estimating the RVM and LCM mineral reserves disclosed in this report, in lieu of transparent mined phosphate ore commodity market prices, the QP estimated Gross Margins Available at the CPP to pay for mined phosphate ores FOB WV Tipple (GMAs) over the Study period.

The GMAs were estimated per dry ton of P₂O₅ required by the CPP and contained in the ore mined and loaded at the WV Tipple. The estimated GMAs are the maximum average annual transfer prices that the CPP could pay for mined ores from the projects and breakeven on a cash basis. GMAs are the forecast fertilizer product revenues minus all CPP cash costs associated with the chemical plant, ore washing and rail transport from RVM and LCM to the CPP. From the viewpoint of Itafos and the CPP, the estimated annual GMAs are economic limits on mining.

To estimate the GMAs, the QP first converted CRU’s \$/mt forecast prices to \$/st. The MAP net-back price forecasts and Itafos Realized SPA price forecast from the CRU Study for the 2019 – 2045 period are shown in \$/st on Figure 19-1.

⁷ (CRU, 2019), pp. 19-20.

⁸ (CRU, 2019), p. 22.

Figure 19-1: Net-back MAP and Realized SPA Price Forecasts for 2019 – 2045 (\$/short ton, real 2019\$ terms)

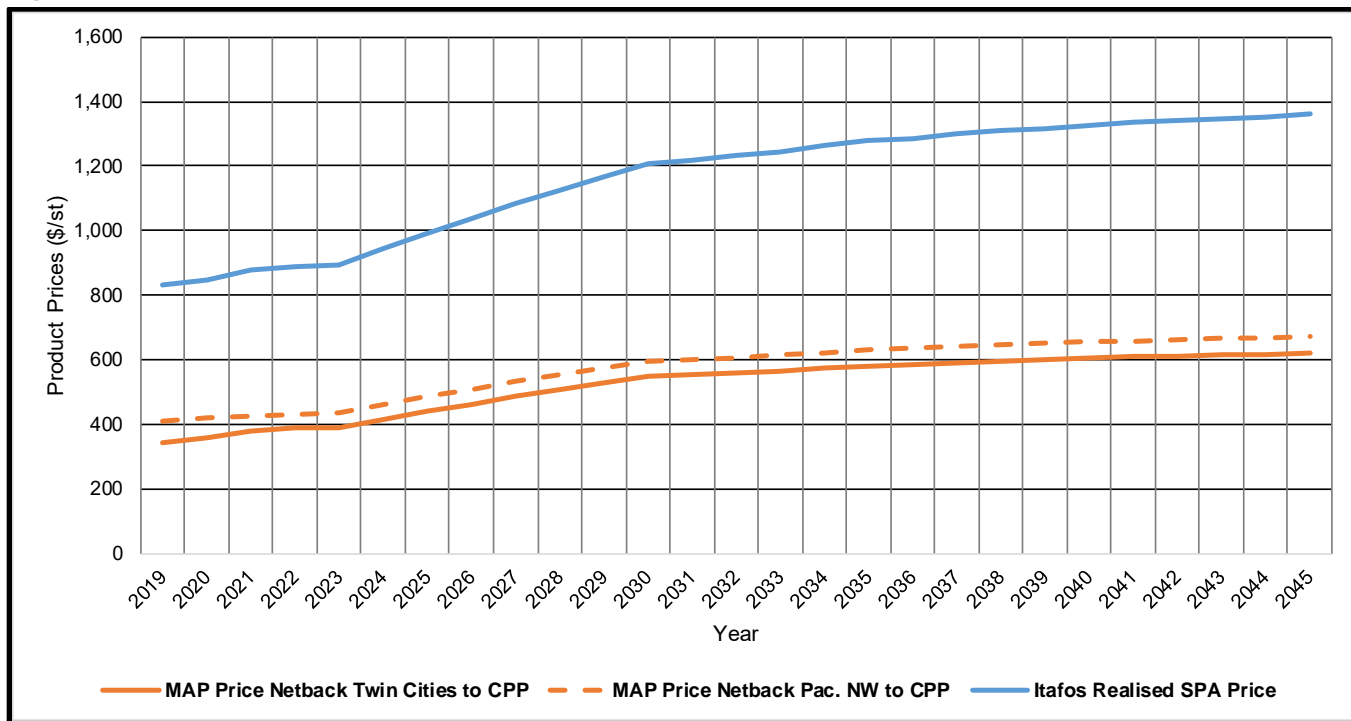

For the Gross Margin Analysis, the QP used the following MAP and SPA prices. The QP used the CRU forecast prices, except for MAP Net-back to CPP prices for 2019 through 2023. For these years, the QP used the 2019 forecast price of \$360/st (\$397/mt) for MAP net-back to CPP that was provided by Itafos. For the years 2020 to 2023, the QP escalated the Itafos-provided 2019 MAP price using the annual percentage change in the CRU Study DAP FOB NOLA price forecast for 2019 to 2023. Itafos reported that the DAP FOB NOLA price index is the price escalator used in Itafos’ current MAP sales agreement. From 2024 to the end of the Study period, the MAP Net-back prices used by the QP were assumed to equal the average of the MAP net-back to CPP prices from the Pacific Northwest and Twin Cities markets to the CPP shown in the CRU Study, see Table 19-1 and Figure 19-1. This assumption was based on Itafos’ direction that after 2023 MAP would be sold in the open market through Itafos’ network of buyers.

Itafos also provided the MAP and SPA annual production tonnages and the CPP’s annual P₂O₅ requirement that remained constant over the Study period. The annual P₂O₅ requirement was also used to drive the LCM and RVM mining and production plans described in Item 16.0 and the H1 and NDR PEA summarized in Item 24.0.

To estimate annual CPP ex-mine cash costs, the QP used the chemical plant cost estimates stated in the CRU Study for years 2019 and 2025 in real 2019\$ terms. Based on these costs, the QP estimated annual escalation rates to apply to the costs each year during the Study period. The QP assumed that annual escalation rates were equal each year between 2019 and 2025, and that those annual rates were assumed to be constant for all years after 2025 for chemical plant costs to produce SPA and MAP. To obtain a total estimated CPP ex-mine cash cost for 2019, the QP added to CRU’s estimated chemical plant costs the actual 2019 year-to-date costs provided by Itafos of washing and transporting phosphate ores from LVM and RVM. The washing and transport costs were escalated thereafter base on CRU’s reported costs for 2019 and 2025. Annual forecast escalation rates in real

2019\$ terms from July 1, 2019 are as follows: chemical plant MAP ex-rock costs – 1.278%%; chemical plant SPA ex-rock costs – 0.922%; and ore washing and rail transport – 0.321%.

The estimated annual CPP ex-mine cash costs were subtracted from the forecast revenues from MAP and SPA sales to determine the GMAs for phosphate ores from RVM and LCM. Table 19-2 shows the details of the QP's GMAs analysis for 2019 and 2025.

Table 19-2: Estimated Gross Margins Available for LCM/RVM Phosphate Ore in 2019 and 2025 (real 2019\$ terms)

Item	Units	2019	2025
MAP Tons Produced	000s st	394.2	394.2
SPA Tons Produced	000s st	190.1	190.1
Total MAP/SPA Production	000s st	584.3	584.3
Average Net-back MAP Price ¹	\$/st	360	463
Itafos Realised SPA Price Forecast	\$/st	832	993
Total Forecast Fertilizer Product Revenue	\$ million	300.2	371.4
CPP Ex-Mine Costs ²	\$ million	-153.1	-162.7
Gross Margin Available for Phosphate Ore	\$ million	147.1	208.7
Total P ₂ O ₅ Requirement from Mines	000s dry st	547.5	547.5
Gross Margin Available per Ton of P₂O₅ Required	\$/dry st	269	381

Notes: 1. 2019 price is based on information provided by Itafos combined with CRU's DAP NOLA price forecast. 2025 forecast is from CRU Study converted to US\$/st by the QP.

2. CPP Ex-Mine Costs include chemical plant cost derived from CRU cost estimates, and ore washing and rail costs based on actual 2019 costs provided by Itafos.

As shown on Table 19-2, there are substantial estimated GMAs to cover costs of mined phosphate ores per ton of P₂O₅ required in 2019 and 2025. The GMAs are forecast to increase in real 2019\$ terms due to forecast fertilizer prices that grow faster than expected real escalation related to all non-mining costs of fertilizer production. The estimated GMAs during the Study Period for LCM and RVM ores are shown in Table 19-3.

Table 19-3: Estimated Gross Margins Available for LCM/RVM Phosphate Ore from 2019 to 2025 (real 2019\$ terms)

Description	Units Year:	2019	2020	2021	2022	2023	2024	2025
MAP Tons	000s st	394.2	394.2	394.2	394.2	394.2	394.2	394.2
MAP Net-Back Price	\$/st	360.2	380.6	401.1	407.7	411.2	438.4	463.2
SPA Tons	000s st	190.1	190.1	190.1	190.1	190.1	190.1	190.1
Realised SPA Price	\$/st	831.9	847.3	875.9	885.7	893.7	943.9	992.8
Total MAP and SPA Tons	000s st	584.3	584.3	584.3	584.3	584.3	584.3	584.3
MAP and SPA Revenues	\$millions	300.2	311.1	324.7	329.1	332.0	352.3	371.3
CPP Ex-Mine Costs	\$millions	-153.1	-154.6	-156.2	-157.8	-159.4	-161.0	-162.7
Gross Margin Available	\$millions	147.1	156.5	168.5	171.3	172.6	191.3	208.7
Required P2O5 CPP Feed (dry st)	000s dry st	547.5	547.5	547.5	547.5	547.5	547.5	547.5
Gross Margin Available per Ton of P₂O₅ Required	\$/dry st	269	286	308	313	315	349	381

19.3 Material Contracts

Contracts are as follows that are material to the issuer and required for project development, including mining, concentrating, smelting, refining, transportation, handling, sales and hedging, and forward sales contracts, or arrangements.

Itafos has a mining contract in place with Kiewit Mining Group of Denver, Colorado (KMG). KMG currently conducts all mining operations at RVM and LCM including waste and ore mining and haulage and all ancillary activities. KMG provides all equipment, labor, supervision, general and support required for the mines. The current contract expires the earlier of December 31, 2023, or the date when mining ceases in RVM.

The QP has reviewed the terms of the mining contract and confirms that the terms, rates or charges are within industry norms.

Itafos has a contract for rail transportation with the Union Pacific Railroad. The terms of the contract are confidential.

Itafos sells 100% of its MAP production to Nutrien under an offtake agreement with pricing tied to an industry benchmark. The offtake agreement is due to expire in 2023. Itafos uses a portion of its CPP SPA production to produce 10-34-0 at four third-party locations. The 10-34-0 produced is contracted and sold as it becomes available. The remaining SPA production is contracted and sold to customers on annual term contracts.

20.0 ENVIRONMENTAL STUDIES, PERMITTING, AND SOCIAL OR COMMUNITY IMPACT

This Item presents the available material information on environmental, permitting, and social or community factors related to the Itafos Conda and PH projects.

20.1 Environmental Studies

For each project, a summary is provided of the results of any environmental studies and a discussion of any known environmental issues that could materially impact Itafos' ability to extract the mineral resources or mineral reserves

Rasmussen Valley Mine

Minerals at RVM are a federal mineral estate leased by Itafos. As such, environmental impacts associated with mining the deposit must be analyzed under the National Environmental Policy Act (NEPA). An Environmental Impact Study (EIS) was jointly conducted by the BLM and the USFS with the participation of other various federal and state agencies. In September 2016, the BLM and USFS issued the Final EIS for the Rasmussen Valley Mine.

The EIS evaluated the following natural resources with respect to anticipated impacts associated with mining the Rasmussen Valley deposit.

- Surface Water
- Groundwater
- Geology and Minerals
- Paleontology
- Air
- Climate
- Noise
- Hazardous Materials and Solid Waste
- Soils
- Vegetation
- Wetlands and Riparian Areas
- Terrestrial Wildlife
- Fisheries and Aquatic Species
- Threatened, Endangered, or Sensitive Species
- Cultural

In addition to evaluating these natural resources, the EIS also evaluated other social impact issues including:

- Land Use Plan Compliance
- Grazing
- Traffic
- Recreation
- Tribal Treaty Rights and Interest
- Social and Economic impacts
- Public Health and Safety

The EIS concluded that the submitted Rasmussen Valley MRP would not create unwarranted environmental impacts with the notable exception of potentially mobilizing selenium into the environment.

The issue of mobilization of selenium is a well-documented and understood phenomenon in the southeast Idaho phosphate patch. The issue centers around historical mines placing overburden that contains selenium in large external overburden stockpiles or piles, i.e., overburden piles placed directly on in-situ soils and former requirements to use selenium bearing shales (e.g., middle or center shales) as growth media on these stockpiles. Over periods of years and decades, as water percolates through these overburden stockpiles or piles, it mobilizes selenium that is released through natural drainage into surface waters and shallow groundwater. The solution to this issue is to place all overburden that contains selenium into the pit backfill. By placing the material into the pits,

water that leaches into the backfill and has sufficient opportunity to undergo various geochemical reactions allows for the leached selenium to attenuate out of the water therefore protecting both surface water and groundwater systems.

The EIS proposed an alternative that utilized the neighboring South Rasmussen Mine's available open pit to eliminate these external overburden stockpiles. By adopting this alternative, the RVM successfully mitigated the issue of potentially impacting local rivers and other surface waters.

In January 2017, the BLM and the USFS issued individual Records of Decision (RODs) recommending that the BLM and USFS issue the necessary permits to commence mining. In February 2017, an Appeal was filed and is currently awaiting review at the US Department of Interior Board of Land Appeals (IBLA). Despite the appeal, in May 2017, the BLM issued a Notice to Proceed. Additionally, the Idaho Department of Lands (IDL) and the Idaho Department of Environmental Quality (IDEQ) utilized the analysis conducted in the EIS to support decisions on various other permits and authorization necessary to commence mining.

Lanes Creek Mine

In February 2004, IDEQ published a report titled "Area Wide Risk Management Plan (RMP): Removal Action Goals and Objectives, and Action Levels for Addressing Releases and Impacts from Historic Phosphate Mining Operations in Southeast Idaho" (Idaho Department of Environmental Quality (DEQ), 2004). Within this report, the LCM was listed as a "non-time critical removal action" site (as defined by the Comprehensive Environmental Response, Compensation, and Liability Act (CERCLA)). At the time of the 2004 Report, the LCM was an inactive historical mine controlled by J. R. Simplot Company (Simplot).

In July of 2008, the IDEQ published the "Lanes Creek Mine Preliminary Assessment Report" (Idaho Department of Environmental Quality (DEQ), 2008). In general, the report found that due to historical mining at the facility there was an environmental risk of selenium entering surface water and groundwater at levels above the then current water quality standards (Note: the standards for surface water have become more stringent since the report was published).

Additionally, the report found that detrimentally high selenium exposure levels potentially existed for both wildlife and livestock. Potential human exposure was determined to be moderate. The primary sources of these environmental impacts included the open pit, an external overburden pile, and abandoned surface water features. The report recommended an early remedial action for the LCM.

In 2009, Agrium approached Simplot regarding the acquisition of LCM. At that time, Agrium began extensive environmental investigations of the site including studies of:

- Surface Water
- Groundwater
- Geology and Minerals
- Air
- Soils
- Vegetation
- Wetlands and Riparian Areas
- Terrestrial Wildlife
- Fisheries and Aquatic Species
- Threatened, Endangered, or Sensitive Species

The results of these studies generally concurred with the 2008 IDEQ findings. In 2015, an MRP was developed and submitted to remediate the site through mining. Agency approval to mine was subsequently granted, mine operations commenced and continue at present. The three primary sources of environmental impact; various external water management features, the pit, and south external overburden stockpile, would be remediated while

the remainder of the economic ore deposit at LCM was mined. The water features were removed and replaced with lined ponds. The remainder of the pit was expanded during mining with overburden being temporarily stored external to the pit. Finally, the temporary external overburden piles would be fully re-handled into the pit as backfill.

H1 and NDR

Minerals at H1 and NDR are a predominantly federal mineral estates with minor amounts (40 acres) of state mineral estates leased by Itafos. As such, environmental impacts associated with mining the deposits must be analyzed under NEPA. An EIS will be jointly conducted by the BLM and the USFS with the participation of other various federal and state agencies. Under Itafos' current planning, the EIS will be performed and completed by the first quarter of 2021.

Itafos is currently performing baseline data collection at H1 and NDR that is required for the NEPA analysis. This work is scheduled to be completed by the last quarter of 2019. To date, other than the previously discussed issue with mobilization of selenium that is common throughout the region, the baseline data collection has not identified any material issues.

Paris Hills

As part of its acquisition of Stonegate Agricom Ltd., Itafos acquired the results of the environmental studies conducted at the PH Project, which were summarized in the July 2013 Paris Hills Project Technical Report (AAI (Agapito Associates, Inc.) Gilbride, Leo J., P.E., Santos, Vanessa, P.G., Skaggs, Gary L., P.E., P.Eng., Patton, Susan B., Ph.D., P.E., Dursterler, Eric, P.E., C.F.M. 2013, dated 18 January 2013, Restated 08 July 2013. (AAI Ref. 758-08)). At the time of the technical report, environmental studies that had been conducted and drawn upon at or near the PH Project site included:

- Environmental Assessment for Paris Hills Prospecting and Exploration Drilling Program (United States Department of the Interior Bureau of Land Management , July 2011).
- Wildlife Habitat - Key wildlife species considered of importance near the PH Project area were identified and based on hunting and environmental sensitivity including Bonneville cutthroat trout, big game (mule deer and elk), migratory birds and sage grouse.
- Wetlands – Wetland studies indicate that insignificant wetlands are anticipated to be affected.
- Surface water – Surface water baseline monitoring and creek flow rate data began to be collected in September 2010, and the monitoring program has continued periodically through 2018. Surface water monitoring was conducted for over 25 stations near the Property, including: creeks, springs, canals (associated with Bear Lake) and intermittent streams located throughout the Project area and vicinity.
- Groundwater - Eight groundwater wells were drilled in 2012 and 2013 to monitor baseline groundwater quality, levels, and flow direction. Six of the wells are within the Project boundary and monitor groundwater near the planned underground mine operation, and two of the wells are located in the valley east of the Project and monitor water levels in the valley fill sediments.
- Geochemistry - A draft Geochemistry study plan was submitted to IDEQ, IDWR, and BLM for review in September of 2012. The agencies requested only minor revisions.

Since the 2013 technical report, additional work and studies were performed related to baseline geochemistry and water resources reporting and mine dewatering. Mine dewatering studies included numerical modeling and sensitivity analyses. This work predicted maximum predicted dewatering flow rates that are significant. Further environmental baseline, characterization and other studies and modeling were recommended to examine in greater detail potential impacts and mitigation required related to groundwater. Work related to mine dewatering is ongoing.

To date, the results of the environmental studies and groundwater work have shown that potential impacts of underground mining at the PH Project may be mitigated through project adaptation, seasonal restrictions, mitigation measures and other approved strategies.

20.2 Overburden Disposal, Tailings Disposal, Water Management, and Site Monitoring

The requirements and plans at each project are as follows for: i) overburden disposal, ii) tailings disposal, and iii) site monitoring and water management both during operations and post mine closure.

Overburden Disposal

At all Itafos Conda projects, overburden is removed to uncover the phosphate beds for mining.

Rasmussen Valley Mine

Overburden at RVM is segregated into three categories; Growth Media (GM), Selenium Overburden (SOVB), and Non-Selenium Overburden (N-SOVB). During the initial phases of mining, all GM is stored in external piles for eventual re-handle as reclamation needs require. All SOVB is placed directly into the existing South Rasmussen Mine (SRM) final phase open pit. SRM is controlled by P4 Production LLC which is a wholly owned subsidiary of Bayer under State and Federal leases. N-SOVB is either utilized to build necessary facilities, such as the haul road, or placed directly into the existing South Rasmussen Mine final phase open pit.

As mining progresses and pit space within the RVM becomes available for backfill, direct placement of overburden as pit backfill begin. Both SOVB and N-SOVB from current phases will be placed in previous mined phases. Backfilling with overburden continues in this fashion for the duration of mining activities in the open pit. This process is termed 'concurrent reclamation.'

During mining, concurrent reclamation will not always be possible as the various phases are of different volumes. At times there is an excess of overburden with no backfill availability. In this case, the excess overburden will be placed on previously backfilled areas. This will create "over filled" areas within the mine backfill. At the end of mining, these overfilled areas will be re-handled and placed as backfill into the final phase of the RVM. This process will leave no final open pit at the end of mining.

The RVM provides a store-and-release cover for all overburden at the RVM to provide additional protection of water quality resulting from any deep percolation of precipitation into and through the overburden. The store-and-release cover consists of three layers; a bottom layer of three (3) feet of alluvium (GM material), a middle layer of two (2) feet of material salvaged from external borrow sites, and a top layer of one (1) foot of GM. The material for the middle layer is a high storage/low permeability material that will be borrowed from areas contiguous with the mine. The entire mine will be seeded with a mix that includes species suited to the various aspects and elevations found at the Rasmussen Valley Mine.

Lanes Creek Mine

Location, surface features, and land ownership greatly constrained the design of the LCM. The LCM is designed as a three-phase mine from south to north with no opportunity for concurrent reclamation. Therefore, three piles external to the pit are designed to temporarily store overburden during mining.

The northern pile is designed for non-Selenium Overburden (N-SOVB), the eastern pile is designed for Growth Media (GM), and the southern pile is designed for Selenium Overburden (SOVB). The southern Selenium Overburden stockpile is built on top of an historic external overburden pile noted in the “Lanes Creek Mine Preliminary Assessment Report” (Idaho Department of Environmental Quality (DEQ), 2008). This historical pile is the source of a majority of the selenium related impacts associated with the LCM.

Overburden disposal will consist of complete re-handle of all three piles with material placed into the open pit as backfill post mining. Backfill operation will be followed by construction of an approved earthen cap and cover over the entire backfill. The requirements for the LCM cap are a minimum of 10 feet of low-Se overburden placed on the uppermost portion of the pit backfill in two 5-foot lifts. These lifts will be compacted using a sheep’s foot roller to provide additional stability to the cover system. Low-Se overburden cover material will be overlain by a cap comprising a minimum thickness of 2 feet of suitable (low-Se) Growth Media.

The removal and placement of the historic external pile material as backfill will address the environmental impacts associated with the historical mining of the site.

Husky 1 and North Dry Ridge

Overburden at H1 and NDR will be segregated into three categories; Growth Media (GM), Selenium Overburden (SOVB), and non-Selenium Overburden (N-SOVB).

The current MRP proposes that during the initial phases of mining, all GM will be stored in external overburden piles for eventual re-handle as reclamation needs require. All SOVB will be placed directly into the existing Maybe Mine open pits. N-SOVB will be either utilized to build necessary facilities, such as the haul road, or placed directly into the existing Maybe Mine open pit.

As mining progresses and pit space within the H1 and NDR becomes available for backfill direct placement of overburden as pit backfill begin. Both SOVB and N-SOVB within the current phases will be placed in previously mined phases. Backfilling with overburden will continue in this fashion for the duration of mining activities in the open pit. This process is termed ‘concurrent reclamation.’

During mining, concurrent reclamation may not always be possible as the various phases are different volumes. At times, there may be an excess of overburden with no backfill space available. At these times the excess overburden may be placed on previous backfill or temporary external storage piles. Excess overburden placed on previously backfilled phases would create an “over filled” area within the mine backfill. At the end of mining these overfilled areas and temporary external storage piles would be re-handled and placed as backfill into the final phase of the H1 and NDR mine. This process would leave no final open pit areas at the end of mining.

The H1 and NDR MRP will propose a store-and-release cover for all overburden at the H1 and NDR site to provide additional protection of water quality resulting from any deep percolation of precipitation into and through the overburden. This store-and-release cover is currently under design.

The entire mine will be proposed to be seeded with a mix that includes species that are suited to the various aspects and elevations found at the H1 and NDR site.

Tailings Disposal

There is no tailings disposal at any site. All phosphate ore is shipped or planned to be shipped by rail to the CPP. All tailings disposal from ore processing is at the CPP site, see Item 24 for additional information on the CPP.

Water Management

At each site, water is, or planned to be, segregated into 'contact' and 'non-contact' water. Contact water is defined as any water that has potentially contacted SOVB material. Contact water is managed under the SWPPP for zero release. The water that is collected as contact water is disposed of by evaporation and dust suppression within the containment area. As an example, all water that contacts the haul road is considered contact water. This water is then collected into lined ponds. This water can then evaporate from the ponds or be utilized for dust suppression on the haul roads where it will either evaporate or flow back to the lined ponds.

Non-contact water is or will be collected in various unlined ponds and allowed to infiltrate or be released once applicable water quality standards are met. The primary water quality criteria that are managed with non-contact water are turbidity and total dissolved solids (TDS).

Site Monitoring

All sites operate or will operate under site-specific Environmental Monitoring Plans (EMP). These plans cover monitoring requirements, procedures, and reporting for: surface water, groundwater, vegetation and soils. The EMPs for RVM and LCM have been approved by all applicable federal and state agencies. Results of monitoring efforts are reported annually. For H1 and NDR, Itafos will develop and submit an EMP for approval by applicable federal state agencies prior to commencing mining at these sites.

For each project, post closure monitoring plans will be developed and submitted for approval to relevant agencies as mining at each site nears each site's end of life.

Paris Hills

PH is not an advanced property because there is no current PFS or PEA for a mining project on the mineral resources. Nonetheless, any future development of the PH mineral resources will require underground mining, which will minimize disposal of mined rock on surface. Under current plans, any economic production from PH would be transported to the CPP for washing and no tailings facility would be required at the project site. Water management presents an issue due to required mine dewatering that will pump substantial groundwater to surface for disposal. Water management studies are in progress as of the Effective Date of this report. Any mining activity at PH will be subject to an EMP, site monitoring and other state and federal regulatory requirements.

Status of Project Permitting Requirements and Applications

For each project, permitting requirements, the status of any permit applications, and any known requirements to post performance or reclamation bonds are as follows.

Rasmussen Valley Mine and Lanes Creek Mine

RVM and LCM are fully permitted and approved for operations. There are no outstanding permits or applications. For RMV, USACE determined that a Section 404 CWA permit is not required as no jurisdictional wetlands are impacted.

Husky1 and North Dry Ridge

Itafos expects that NEPA review will begin on the H1 and NDR projects in early Q1 of 2020 with the BLM and the USFS both issuing individual Record of Decisions (RODs) within 12 months of the commencement of NEPA. It is anticipated that the BLM and USFS will recommend the issuance of the necessary permits to commence mining per the NEPA determined "Preferred Alternative." It is anticipated that the Preferred Alternative will essentially be the submitted MRP but will contain some change and refinements that cannot be anticipated at this time.

Additionally, it is anticipated that the United States Army Corps of Engineers (USACE), the Idaho Department of Lands (IDL), and the Idaho Department of Environmental Quality (IDEQ) will utilize the analysis conducted in the EIS to support decisions on various other permits and authorizations necessary to commence mining.

A list of permits necessary to commence operations at H1 and NDR is as follows:

- BLM: ROD, Notice to Proceed, Lease Modification Approvals
- USFS: ROD and Special Use Permit(s)
- USACE: 404 Permit and Stream Alteration Permit
- IDEQ: 401 Permit, Permit to Construct (Air Permit), SWPPP, and Points of Compliance (POC).
- IDL: Mine Reclamation Approval
- Caribou County: Conditional Use Permit

It is anticipated that all permits will be issued by the end of 2021.

Paris Hills

PH is not an advanced property, because there is no current PFS or PEA for a mining project on the PH mineral resources. No development or mining plan exists for PH and therefore no permits are required at this time.

If a decision is made to proceed with further development of an underground mining operation, then the preferred permitting scenario is to mine on state and private lands before federal leases that trigger the NEPA review process. However, any development or mining at PH will require baseline environmental and all other studies required for mine permitting. Due to the complex nature of surface and mineral ownership at PH, once an MRP is prepared and submitted, an Idaho State Mine and Reclamation Plan and/or a Federal NEPA-based EIS approval will be required dictating the full extent of environmental studies to be addressed. In any case, further environmental baseline characterization and other studies and modeling are very likely to be required in greater detail to address potential impacts and mitigation required related to surface water and ground water, geochemistry, wildlife habitat, and wetlands. The results from future baseline studies will be used to support environmental impact studies for permitting and for required Point of Compliance (POC) applications.

Because most of the underground mining at the PH Project would take place below the regional water table; substantial quantities of groundwater must be pumped from the mine before and during mining. Water from the dewatering wells will be retained, as needed, on site, or discharged off site. Itafos is currently conducting further technical studies associated with groundwater pumping and discharges.

Future permits required for such dewatering will include drilling permits and an appropriation permit to dewater. Permitting for dewatering will be a phased process with additional permits added as needed. Itafos would apply for an individual Idaho Pollutant Discharge Elimination System (IPDES) Permit to authorize surface water discharges of dewatered groundwater and treated mine drainage water (MDW).

Reclamation Bonds

Reclamation bonds are required by BLM, USFS, and IDL as assurance to cover the estimated costs of mine reclamation and closure. Bond amounts are based on reclamation plans and cost estimates that are reviewed and revised periodically with bonding requirements adjusted appropriately. Financial assurances required for post closure long-term monitoring and maintenance costs are also estimated and incorporated into bond amounts. Approvals are required from both Federal and State regulatory agencies for amendments to reclamation, closure plan amendments and bond adjustments.

Itafos maintains surety bonds for all current bonding requirements associated with mining. Currently, reclamation bonds are posted in the total amounts of \$21.3 Million for RVM and \$16.5 Million for LCM. The bond amounts will be adjusted as the mines are closed and reclamation is completed.

Reclamation bonds will be required at H1, NDR, and PH prior to commencement of mining. Bond amounts have not yet been established.

Potential Social or Community Related Matters

The following discusses any potential social or community related requirements and plans for the projects and the status of any negotiations or agreements with local communities.

Itafos Conda Projects

There are no known social or community related requirements associated with any of the Itafos Conda operating mines and planned projects. There are no ongoing negotiations or agreements with local communities.

Itafos actively supports and develops partnerships with stakeholder groups (governments, development agencies, non-profit entities, and citizens) who display their own commitment toward sustainability. The partnerships may be formal agreements or more informal relationships, but in general serve the purpose of maintaining close ties with local communities and open communications regarding potential issues that may arise related to Itafos' active operations, development, or exploration projects. Expenses associated with the partnerships are primarily in the form of employee time and associated expenses of meetings, sponsored events and donations to local activities and charities. The costs related to the partnerships are typically in the range of \$50,000 to \$100,000 annually.

Paris Hills

PH is not an advanced property, because there is no current PFS, or PEA, for a mining project on the PH mineral resources. Currently there are no known potential social or community related requirements and plans for the project and nor any negotiations or agreements with local communities.

Reclamation and Asset Retirement Obligation Requirements

Final reclamation and closure of any active mine is required for both federally permitted and state permitted mines. Mine closure (i.e. reclamation) is analyzed through NEPA and is a required part of a submitted MRP (43 CFR 3592). The State of Idaho also requires approval of mine reclamation plans (IDAPA 20.03.02.69 & 70).

Rasmussen Valley Mine

During operations, direct placement of overburden as pit backfill (concurrent reclamation) reduces the volume of material requiring re-handle post mining. Direct placement of overburden is not always possible as the volume of overburden and available volumes of open pit space are not always fully synchronized. As such the RVM will create overfill piles that will be placed on backfill during mining.

Additionally, the process of concurrent reclamation leaves open pit space at the end of mining.

Post mining closure will include the re-handling of these overfill piles into the final phases of the mine, so no open pit remains. All facilities will be removed from the site. All earthen features; haul roads, equipment ready lines, and water management features, will be removed and collected material placed in the pit as backfill. The approved cap and cover will be built on all areas that did not receive the cap and cover during mining.

Post mining monitoring is expected to include monitoring of groundwater, surface water, and vegetation. Additionally, it is expected that minor issues such as rilling, slumping, and washouts will require repairs while the site settles and reaches a state of balance.

The final reclamation and mine closure cost estimate associated with RVM (including the haul road to Wooley Valley tipple and the mine shop) is about \$52 Million, which is to be predominately incurred over a period of 4 years after production ceases in the year 2025.

Lanes Creek Mine

The LCM is designed as a three-phase mine from south to north with no opportunity for concurrent reclamation. Therefore, three piles external to the pit are designed to temporarily store overburden during mining. The northern pile is designed for non-Selenium Overburden, the eastern pile is designed for Growth Media (GM), and the southern pile is designed for Selenium Overburden. The southern Selenium Overburden pile is built on top of the historic external pile noted above and in the Lanes Creek Mine Preliminary Assessment Report. This historic pile is the source of a majority of the negative environmental impacts associated with the LCM.

Mine closure and reclamation will include overburden disposal that consists of full re-handle of all three piles into the final open pit as backfill. The removal of the historic external pile as backfill will address the environmental impacts associated with the historic mining of the site, remediation through mining.

The approved cap and cover will be built on all areas disturbed by mining.

All facilities will be removed from the site.

All earthen features; haul roads, ready lines, and water management features, will be removed and collected material placed in the pit as backfill.

Post mining monitoring is expected to include monitoring of; groundwater, surface water, and vegetation.

Additionally, it is expected that minor issues such as rilling, slumping, and washouts will require repairs while the site settles and reaches a state of balance.

The final reclamation and mine closure cost estimate associated with LCM is about \$4.8 million to be incurred over a period of 2 years after production and backfilling ceases in the year 2021.

H1 and NDR

During operations, direct placement of overburden as pit backfill (concurrent reclamation) reduces the volume of material requiring re-handle post mining. Direct placement of overburden is not always possible as the volume of overburden and available volumes of open pit space are not always fully synchronized. As such, the H1 and NDR site may create overfill piles that will be placed on backfill and/or temporary external storage piles during mining. Additionally, the process of concurrent reclamation leaves open pit space at the end of mining.

Post mining closure will include the re-handling of these overfill and temporary piles into the final phases of the mine so no open pit remains. All facilities will be removed from the site. All earthen features; haul roads, ready lines, and water management features, will be removed and collected material placed in the pit as backfill. The approved cap and cover will be built on all areas that did not receive the cap and cover during mining.

Post mining monitoring is expected to include monitoring of; groundwater, surface water, and vegetation.

Additionally, it is expected that minor issues such as rilling, slumping, and washouts will require repairs while the site settles and reaches a state of balance.

The final reclamation and mine closure cost estimate associated with H1 and NDR is about \$86 million to be incurred over a period of 5 years for H1 and 2 years for NDR after production ceases.

Paris Hills

PH is not an advanced property, because there is no current PFS, or PEA, for a mining project on the PH mineral resources. Currently there are no requirements related to mine closure and reclamation at this site and final reclamation and mine closure costs have therefore not been estimated for the PH project.

21.0 CAPITAL AND OPERATING COSTS

For the PFS, Golder estimated the annual production costs of the phosphate ore produced in the LOMP as described in Item 16. Costs were estimated on an FOB basis for run-of-mine ore loaded onto trains at the WV Tipple. Currently, mining at RVM and LCM is performed by Kiewit Corporation (Kiewit) under a mining contract. Kiewit costs therefore represent the bulk of the mine operating costs. Cash operating costs include operating and maintenance labor; supplies; repair parts; power; equipment leases; overheads and administration; royalties; and, miscellaneous costs. All costs are estimated in real 2019\$ terms.

The PFS cost model developed to estimate operating costs was based on historical costs from January of 2016 through May of 2019. Cost data was provided through Itafos Conda's SAP financial accounting system. The data was organized and analyzed to develop functional costs, suitable to develop the operating costs model, with due consideration of changes to the operation over the data collection timeline. Golder used the functional cost data to develop the operating cost model to estimate future LOMP costs. Table 21-1 summarizes the economic assumptions that were built into the cost model.

Table 21-1: Summary of Economic Assumptions

Mine Production	Units	Total	Annual Average
Overburden/Interburden Mined	cubic yards 000s	51,680	7,951
Overburden/Interburden Mined	wet tons 000s	102,585	15,782
Ore Mined	wet tons 000s	14,362	2,210
Ore Mined	dry tons 000s	12,926	1,989
Strip Ratio	cubic yard/wet ton ore	3.60	3.60
Ore Delivered to the CPP (includes stockpile reclaim)	dry tons 000's	14,363	2,052
Grade Delivered P ₂ O ₅	% dry basis	26.6%	26.6%
Contained P ₂ O ₅ Delivered to the CPP	dry tons 000s	3,826	547
Unit Costs	Units	Average	
Ore Cost per ton Mined	\$/wet ton	7.47	
Overburden/Interburden Cost per ton Mined	\$/wet ton	3.86	
Overburden/Interburden Cost per cubic yard Mined	\$/cubic yard	7.65	
Royalty Cost per ore ton Mined	\$/wet ton	1.75	
Royalty Cost per ore ton Mined	\$/wet ton	1.94	
Tipple Cost per ore ton Delivered	\$/wet ton	1.32	

Notes:

Starting stockpile inventory is 1.4 Mt dry

Mining total and annual averages based on mining from July 2019 through December 2025.

Delivered total and annual averages include reclaim from stockpile through June 2026.

All costs developed were for the production and delivery of phosphate ore to the WV Tipple and loaded on to rails cars. Costs included mine development; all pre-stripping and mining functions; mine services, concurrent reclamation, stockpiling at the WV Tipple and loading onto rail cars. Cost associated with final reclamation and asset retirement are provided in Item 20.

As shown in Table 21-2, the average cash operating cost during the production of the reserve areas of the mine plan is \$38.42/dry ton of ore and \$144.22/dry ton of contained P₂O₅.

Table 21-2: Mean Operating Cost (US\$)

Item	Units	Value
Total Cost	\$000s	551,851
Total Cost Delivered Ore	\$/dry ton	38.42
Total Cost Delivered P ₂ O ₅	\$/dry ton	144.23

Mining capital for the completion of the RVM and the LCM was minimal as the properties are both fully developed, and mining is accomplished through a mining contractor. Capital expenses were estimated for the Blackfoot River Road realignment and Main Shop Generator and totaled \$1.7 M.

22.0 ECONOMIC ANALYSIS

Principal Assumptions

The following principal assumptions were used for the RVM and LCM PFS economic analysis supporting the mineral reserve estimates stated in Item 15.0.

- The phosphate ore production schedule is based on the Measured and Indicated Mineral Resources stated in Item 14 for RVM and LCM and the Modifying Factors applied to those Resources as described in Item 15. In accordance with CIMDS, only Measured and Indicated Mineral Resources are used to estimate Mineral Reserves.
- The annual phosphate ore production schedule is based on supplying annually about 547,500 dry tons of P_2O_5 to the CPP in phosphate ore with P_2O_5 grade greater than 20%.
- The RVM and LCM mining and production plans are based on the surface mining methods described in Item 16.
- Operating and capital cost estimates for the economic analysis are as described and justified in Item 21.
- Contract mining operations were assumed to continue for the full period of the economic analysis. Contract mining has been successful at the Itafos Conda mines historically and it is reasonable to assume that contract mining services will continue to be available in southeastern Idaho at competitive prices over the period of the economic analysis.
- Union Pacific rail service is assumed to continue over the economic analysis period. The UPRR is a major national rail service provider and rates for transport of phosphate ore to the CPP are assumed to remain consistent with existing rates.
- The economic analysis period is 7 years (including 6 months of stockpile reclaim after mining), which exhausts the Measured and Indicated Resources at the RVM and the LCM. All ore production and final reclamation costs at the RVM and the LCM are assumed to be recovered through annual imputed transfer prices of ore delivered to the Rail Loadout for transport to the CPP.
- To determine the annual cost to Itafos Conda of phosphate ore FOB WV Tipple including time value of money and risk, an assumed margin is added to the estimated annual capital and operating costs that is sufficient to generate a 7% pre-tax IRR to the mining operation. The 7% figure reflects the estimated time value of money over the economic analysis period plus a risk premium. The risk premium reflects the assumptions that future conditions affecting the mineral projects are not materially different than conditions prevailing as of the Effective Date. That is, expected geological and mining conditions at the mineral projects and economic and political conditions prevailing generally as of the Effective Date will continue over the LOMP period.
- In the cashflow forecast, the production cost plus the assumed margin is shown as an imputed transfer price of phosphate ore FOB Railcar.

Discounted Cashflow Forecast

In the PFS, a discounted cashflow (DCF) model was developed to perform an economic analysis of the projected LOMP capital and operating costs described in Item 21. The discounted cashflow forecast for phosphate ore produced and loaded in the LOMP from RVM and LCM is shown in Table 22-1.

Table 22-1: DCF Forecast (real 2019\$ terms)

Item	Units	Totals or Avg.	2019 (H2)	2020	2021	2022	2023	2024 to 2029	2030 to 2055
<u>Production</u>									
Waste Tonnage	short tons (wet) 000s	102,585	8,186	15,965	18,069	17,572	16,108	26,684	-
Ore Mined @ 10% Moisture	Tons (wet) 000s	14,362	1,102	2,104	2,231	2,338	2,338	4,250	-
P2O5 in Ore Mined	Wt. % (dry)	26.7%	28.1%	27.6%	27.2%	26.9%	26.4%	25.8%	-
Ore Loaded FOB Rail (includes Stockpiles)	Tons (dry) 000s	14,363	1,040	2,013	2,002	2,023	2,053	5,232	-
P2O5 Grade in Ore Loaded FOB Rail	Wt. % (dry)	26.6%	26.3%	27.2%	27.4%	27.1%	26.7%	26.0%	-
Tons P2O5 in Ore Loaded FOB Rail	Tons (dry) 000s	3,826	274	548	548	548	548	1,360	-
<u>Mining Costs</u>									
Waste	\$ 000s	395,480	33,148	62,068	69,173	67,271	61,667	102,152	-
Ore	\$ 000s	107,231	9,205	16,701	16,156	16,986	17,044	31,138	-
Concurrent Reclamation Cost	\$ 000s	4,051	225	695	918	878	467	868	-
Royalty Cost	\$ 000s	25,117	2,464	4,389	3,756	3,897	3,827	6,785	-
Tipple and Stockpile Cost	\$ 000s	19,972	1,418	2,990	2,902	3,086	3,086	6,490	-
Total Mining Cost	\$ 000s	551,851	46,460	86,844	92,905	92,119	86,091	147,433	-
Total Cost per Ore Ton	\$/ton (wet)	38	42	41	42	39	37	35	
Total Cost per Ton P2O5	\$/ton P2O5	144	170	158	170	168	157	108	0
<u>Final Reclamation & Closure Costs</u>									
Total Final Reclamation & Closure Costs	\$ 000s	54,216	0	0	370	1,054	1,308	33,700	17,783
<u>Capital</u>									
Capital Costs	\$ 000s	1,734	0	0	34	1,700	0	0	0
Working Capital (Initial is at Time 0)	\$ 000s	62,681	0	-14,292	11,465	2,568	-2,770	-60,552	688
Total Capital	\$ 000s	1,523	0	-14,292	11,499	4,268	-2,770	-60,552	688
<u>Margin</u>									
Final Reclamation Accrual	\$ 000s	26,296	1,883	3,766	3,766	3,766	3,766	9,348	0
Risk Margin	\$ 000s	30,434	2,179	4,359	4,359	4,359	4,359	10,818	0
Total Cost of Ore	\$ 000s	623,183	50,522	94,969	101,400	101,299	95,524	179,469	0
Total Cost Of Ore (Transfer Price)	\$/ton P2O5	163	184	173	185	185	174	132	0
<u>Discounted Cash Flow Analysis</u>									
	Period	0	1	2	3	4	5	6-10	11 - 36
Annual Cash Flows	\$ 000s	-62,681	4,063	22,417	-3,374	3,857	10,895	58,888	-18,472
Cumulative Cash Flow	\$ 000s	-62,681	-58,618	-36,201	-39,575	-35,718	-24,823	138,855	90,315
Discounted Cash Flows	\$ 000s	0	3,926	20,248	-2,848	3,043	8,033	38,987	-8,709
Internal Rate of Return	7%								

As shown in Table 22-1, an average transfer price of \$163 per ton of contained P_2O_5 in run-of-mine ore delivered FOB Rail at WV Tipple is required to cover all phosphate ore production and final reclamation costs and produce a 7% pre-tax IRR to the mining operations. During full production years, the transfer prices required vary over the period from \$173 to \$185/ton of P_2O_5 (note: last year of full production is 2024).

Net Present Value, Internal Rate of Return, Payback Period

The IRR on the estimated discounted cashflows is 7%, which is considered reasonable for these ongoing mining operations and the market certainty of the CPP. By definition, using the 7% IRR as a discount rate yields an NPV of \$0. This economic treatment is considered reasonable given that the RVM and the LCM are captive feedstock suppliers to the CPP and are not selling to a commodities market. Working capital required for the operation is substantial at nearly \$63 M, which is primarily the imputed value of the ore stockpiles existing as of the Effective Date. This value is assumed to be a negative cash flow at time zero, and changes in working capital are considered in the calculation of cash flows for the IRR and transfer price calculations. . Because the mining operation is well established, only \$1.7 M of ongoing capital expenditure is required in 2021 and 2022. Including the working capital, the overall payback period is less than six years.

Taxes, Royalties, Other Government Levies or Interests

Because Itafos is vertically integrated, the phosphate mines do not file separate tax returns on their operations. Costs of exploration, development and production including depreciation, depletion and amortization related to the mining operations are deductions on the overall corporate returns for Itafos Conda LLC and Paris Hills Agricom Inc. Because of the vertically integrated nature of Itafos Conda, no state or federal income tax expense or benefit has been included in the DCF model for the mining operations.

Economic Analysis

Because the Itafos phosphate mines are captive suppliers of run-of-mine ore to the Itafos CPP, market demand risk is negligible. Market price risk is dependent on the ability of Itafos to pay the mining and loading costs of the run-of-mine phosphate ore over the study period. Itafos' ability to cover the mining and loading costs is dependent upon sales of fertilizer products produced from the CPP and the Gross Margin available after all CPP operating costs except for phosphate ore. Item 19 summarizes the 2019 CRU Phosphate Study of forecast fertilizer MAP and SPA sales prices and estimated chemical plant ex-Rock costs. Based on the CRU Study information, Table 22-2 shows the forecast Gross Margins from fertilizer product sales in 2019 and 2025 that are available to cover phosphate ore production costs.

Phosphate ore is economical if the estimated transfer price is less than the estimated Gross Margin available. Table 22-2 compares the total estimated cost of phosphate ore with the forecast GMAs from MAP and SPA fertilizer product sales.

Table 22-2: Economic Analysis – Comparison of Transfer Prices with Gross Margins Available (real 2019\$ terms)

Item	Units	2019	2020	2021	2022	2023	2024	2025
Gross Margin Available per ton of P_2O_5 Required	\$/dry st	269	286	308	313	315	349	381
Transfer Price per ton of P_2O_5 Loaded FOB Rail	\$/dry st	184	173	185	185	174	175	124
Excess Gross Margin per ton of P_2O_5 Required	\$/dry st	85	113	123	128	141	174	257

For both MAP and SPA products the forecast net margins remaining are positive and substantial as percentages of the forecast market prices of MAP and SPA. For this reason, the phosphate ore production plan from the RVM and the LCM is economical and supports the Mineral Reserve estimates stated in this Technical Report.

Sensitivity Analyses

Using variants in commodity price, grade, capital and operating costs, or other significant parameters, as appropriate, a sensitivity analysis was performed on the discounted cashflow model with the following results.

If capital and operating costs in the economic model are increased by 25% in real 2019\$ terms, then the result is that the average transfer price over the life of the RVM and the LCM will increase from \$163 to \$201 per ton of P₂O₅, delivered or about 23%. The impact of the price increase can be absorbed by forecast increases in fertilizer product prices and the resulting forecast GMAs to cover phosphate ore production, see Table 22-3.

Table 22-3: Operating Cost Sensitivity Analysis (real 2019\$ terms)

Item	Units	2019	2020	2021	2022	2023	2024	2025
Gross Margin Available per ton of P ₂ O ₅ Required	\$/dry st	269	286	308	313	315	349	381
Transfer Price per ton of P ₂ O ₅ Loaded FOB Rail	\$/dry st	229	215	229	229	216	217	152
Excess Gross Margin per ton of P ₂ O ₅ Required	\$/dry st	40	71	79	84	99	132	229

If the P₂O₅ grade is diminished, then more tons of phosphate ore must be mined to maintain the CPP P₂O₅ requirement of 547,500 tons (dry basis) per year. This will increase mining contractor costs and will also reduce the GMAs due to increased costs associated with washing, rail transportation and royalties. Assuming that the average grade of ore in the production plan is reduced from 26.6% to a minimum of 20% P₂O₅, then ore production required would need to increase by 25%, which would result in an associated increase to the average transfer price over the life of the RVM and the LCM will increase from \$163 to \$217 per ton of P₂O₅ delivered of phosphate ore.

As shown on Table 22-4, the estimated GMAs per year are remain significantly higher than the estimated transfer price of the 20% P₂O₅ phosphate ore. For this reason, a lower P₂O₅ grade does not undo the economic viability of phosphate ore production from the RVM and the LCM.

Table 22-4: Grade Sensitivity Analysis (real 2019\$ terms)

Item	Units	2019	2020	2021	2022	2023	2024	2025
Gross Margin Available per ton of P ₂ O ₅ Required	\$/dry st	269	286	308	313	315	349	381
Transfer Price per ton of P ₂ O ₅ Loaded FOB Rail	\$/dry st	246	231	247	246	232	233	165
Excess Gross Margin per ton of P ₂ O ₅ Required	\$/dry st	23	55	61	67	83	116	216

23.0 ADJACENT PROPERTIES

Under NI 43-101, an “adjacent property” means a property:

- a) in which Itafos does **not** have a [real property] interest; (bracketed language added by the QP)
- b) that has a boundary reasonably proximate to the property being reported on; and
- c) that has geological characteristics similar to those of the property being reported on.

The sources of the information in this Item are identified in Item 27.

The qualified person has been unable to verify the information presented in this Item and the information is not necessarily indicative of the mineralization on the Property that is the subject of this report;

The following adjacent properties are material to the development of the RVM, LCM, NDR projects, and H1 Project. See Figure 23-1 for locations of each adjacent property.

The South Rasmussen Mine (SRM) on State Lease E-07958 and Federal Lease I-23658 is owned by Bayer. SRM is located about one half-mile northwest of the RVM and was operated from 2001 to 2013. Site reclamation was largely completed in 2014, and in 2015 the Idaho Department of Environmental Quality (DEQ) issued Bayer a Point of Compliance (POC) Determination. Subsequently, POC groundwater monitoring wells were installed in addition to construction of a series of permeable reactive barriers (PRB) to reduce selenium concentrations in the groundwater. In January 2017, a Record of Decision (ROD) was issued for the RVM. The preferred alternative, the Rasmussen Collaborative Alternative (RCA), included placement of the initial RVM overburden into the SRM open pit to facilitate additional reclamation of the SRM. Itafos commenced backfilling operations into SRM in October 2017 and is planned to continue until into the first half of 2020.

The Nutrien North Maybe Mine (NMM) on Federal Lease I-04 abuts the south end of the NDR Lease. The North Maybe Mine is currently undergoing investigation and remediation through Comprehensive Environmental Response, Compensation and Liability Act (CERCLA) under an Administrative Settlement Agreement and Order on Consent (ASAOC) between Nutrien, US Forest Service (USFS), Idaho Department of Environmental Quality (IDEQ) and the Shoshone -Bannock Tribes with the (USFS) as Lead Agency. It is anticipated that mining on the NDR Lease will occur in the first few years of the mine plan and initiated by overburden removal to gain access to the ore. Overburden from NDR will be placed in the existing NMM pit as backfill, contingent on successful execution of agreement with Nutrien, approval with the regulatory agencies and the compatibility of NEPA (National Environmental Policy Act).

The NMM West Ridge on Lease ID-04, located just south of the NDR Lease, is currently undergoing investigation and remediation through CERCLA under a Unilateral Administrative Order (UAO) between Huntsman Advanced Polymers and Wells Cargo Corporation and Federal Agencies (USFS as Lead Agency). Itafos plans to utilize a portion of this area to access NDR.

The South Maybe Canyon Mine (SMCM) on Federal Lease I-04 is currently owned by Nutrien. Itafos plans to initially haul and place overburden from H1 into the existing SMCM north and south pits as backfill. This plan is contingent on a successful agreement with Nutrien, approval with the regulatory agencies and compatibility with NEPA. There are phosphate ore resources remaining in the southern portion of the SMCM that will be extracted in conjunction with mining the Known Phosphate Leasing Area (KPLA) described later in this Item. This will facilitate access to the SMCM for backfilling the pit(s). The SMCM is currently undergoing investigation and remediation through CERCLA under an Administrative Settlement Agreement and Order on Consent (ASAOC) between Nutrien, USFS, IDEQ, and the Shoshone -Bannock Tribes with the USFS as Lead Agency).

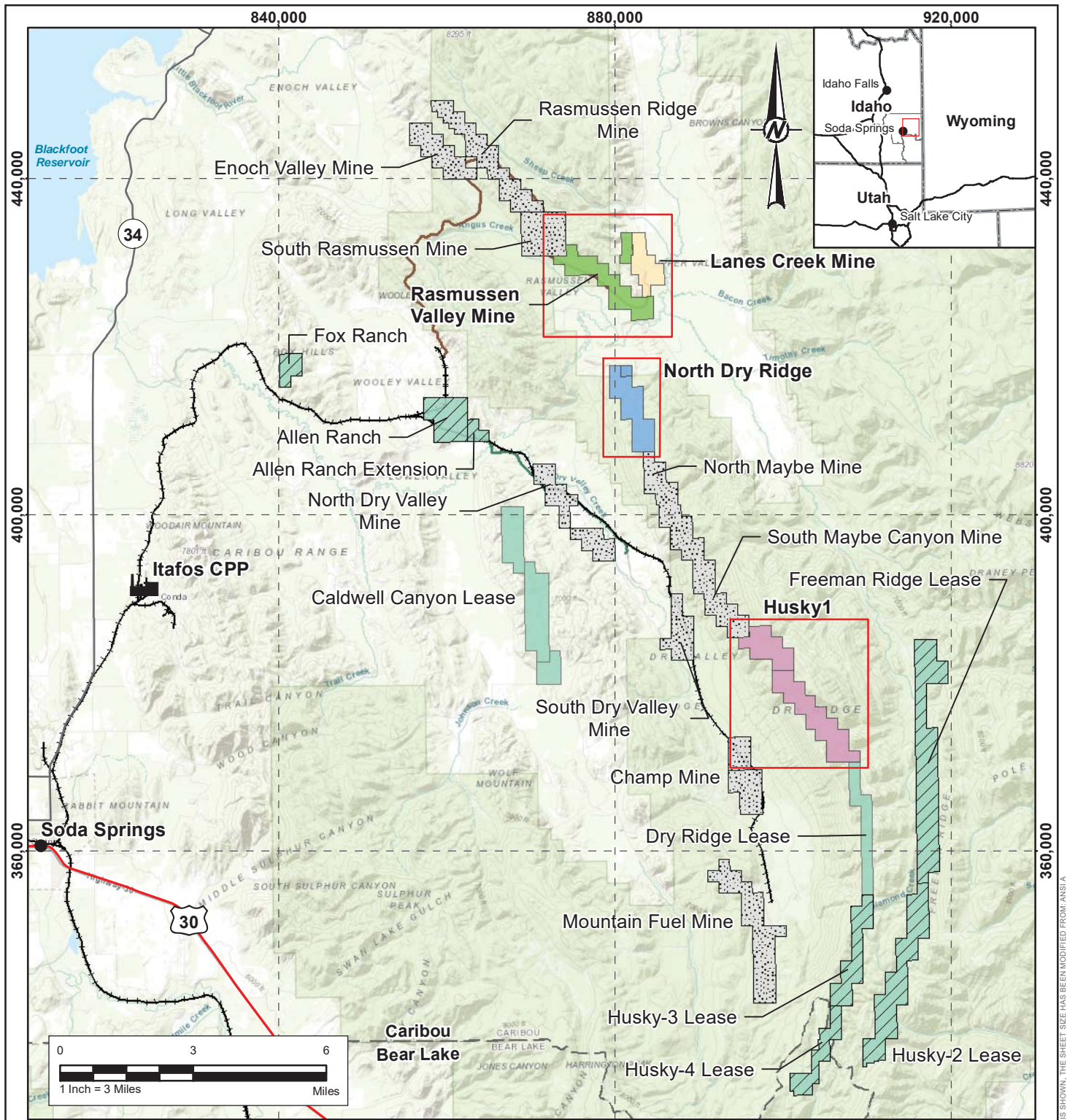

LEGEND

- Project Map Extents
- U.S. Highway
- State Highway
- Public Vehicle Access
- Haul Road
- Railroad
- Itafos CPP
- Adjacent Leases**
- Potential Resources
- Mined Out
- Leased by Itafos

REFERENCE(S)
 1. COORDINATE SYSTEM: NAD 1983 STATE PLANE IDAHO EAST FIPS 1101 FEET
 2. DATA PROVIDED BY ITAFOS CONDA LLC

CLIENT
 ITAFOS CONDA LLC

PROJECT
 NI 43-101 TECHNICAL REPORT FOR CONDA PHOSPHATE OPERATIONS

TITLE
ADJACENT PROPERTIES MAP

CONSULTANT	YYYY-MM-DD	2019-11-22
	DESIGNED	-
	PREPARED	EFT
	REVIEWED	RM
	APPROVED	TM



PROJECT NO.	CONTROL	REV.	FIGURE
18114499	0001	-	23-1

IF THIS MEASUREMENT DOES NOT MATCH WHAT IS SHOWN, THE SHEET SIZE HAS BEEN MODIFIED FROM: ANSI/A

Separating the H1 Lease and the SMCM is an unleased section of land called the KPLA. As part of the H1 Mine and Reclamation Plan (MRP) application, Itafos requested that this KPLA be joined to the H1 Lease through a lease modification which would allow Itafos to extract the KPLA phosphate resources. Notable to this KPLA is that an active pipeline currently traverses the area, however, an agreement is in place that the pipeline will be relocated at the owner's cost.

The following adjacent properties not owned by Itafos have phosphate mineralization.

The Dry Ridge Federal Lease I-07238 held by Solvay USA Inc. abuts the south end of the H1 Lease and is approximately 520 acres and extends along the known north-south trending outcrop of phosphate bearing horizons.

The Caldwell Canyon Leases ID-000002, ID-014080 and ID-013738 are owned by Bayer. The center of the Caldwell Canyon Leases is located about six miles south-southeast of the North Dry Ridge (NDR) Lease. In May 2019, the Bureau of Land Management (BLM) released the Final Environmental Impact Statement (EIS) for the Caldwell Canyon Mine and issued a Record of Decision (ROD) in August 2019 to approve the Caldwell Canyon Mine Project, an open pit phosphate mine.

24.0 OTHER RELEVANT DATA AND INFORMATION

This Item presents additional information or explanations that were referenced in other Items. Although the references were not specific to the Property, the additional information or explanations are provided to make the references more understandable and not misleading.

24.1 H1 and NDR Preliminary Economic Assessment (Mining)

Itafos engaged Golder to compile this NI 43-101 TR on its ID mineral projects that are in operation or under development. As part of this TR, Golder was requested to prepare a Preliminary Economic Assessment (PEA) for the H1 and NDR properties.

Itafos Conda operates the RVM and the LCM with phosphate ore depletion estimated in the second half of 2025. H1 and NDR are being developed to replenish the ore reserves and ensure phosphate rock continuity to the CPP. Mining methods are the same for the new properties and ore will continue to be transported via the Union Pacific Railroad (UPRR) from the mines to the CPP. H1 and NDR are located just a few miles south of the RVM and are in proximity to other historical mine sites. These properties benefit from existing haul access, rail line and shop facilities, all of which will facilitate development of the deposits at a reduced cost. The proposed plan makes use of backfill areas available in the historical mine sites guided by best management practices encouraged by the regulators. Significant exploration drilling has been completed on the properties and metallurgical testing is underway.

The following sub-Items describe the mine planning and economic analysis performed at the PEA level for H1 and NDR. The basis for mine production is the MII Mineral Resources presented in Item 14. For the H1 deposit, preliminary rock characterization and metallurgical studies are discussed in Item 17. It should be noted that the PEA includes Inferred Mineral Resources which is not allowed for mineral reserve classification. PEA level studies are limited in their use as defined by the Canadian Institute of Mining (CIM Standing Committee on Reserve Definitions, Nov. 27, 2010):

“Due to the uncertainty that may be attached to Inferred Mineral Resources, it cannot be assumed that all or any part of an Inferred Mineral Resource will be upgraded to an Indicated or Measured Mineral Resource as a result of continued exploration. Confidence in the estimate is insufficient to allow the meaningful application of technical and economic parameters or to enable an evaluation of economic viability worthy of public disclosure. Inferred Mineral Resource must be excluded from estimates forming the basis of feasibility or other economic studies.”

Golder performed a high-level exercise of the typical mine planning process. This exercise included pit optimizations, pit designs, overburden stockpile designs and a high-level schedule for both H1 and NDR. Rudimentary haulage analysis and unit costs were used to estimate operating costs. Capital cost estimates were developed by Itafos and Golder based on current and historical Conda projects, information developed for similar projects and costing services such as RS Means.

Pit Optimizations

A pit optimization was completed utilizing the block models for both H1 and NDR, and the following assumptions found in Table 24-1.

Table 24-1: Preliminary Economic Assumptions

Item	Units	Value
Overburden Cost	\$/wet ton	3.83
Potential Feed	\$/wet ton	7.27
Stockpile and Tipple	\$/wet ton	1.32
Royalty Cost (average)	\$/wet ton	1.70
Gross Margin per Ton P ₂ O ₅ FOB Rail	\$/dry ton	271
Mining Recovery	percent	100
Dilution	percent	0

For information on the Gross Margin available per P₂O₅ ton FOB Rail refer to Item 19.0.

Additional information included in the pit optimizations included:

- A P₂O₅ cutoff-grade (COG) of 20% was applied to the exercise.
- Only blocks classified as Measured, Indicated and Inferred (MII) above the COG were allowed as potential mill feed.
- H1:
 - The southern pit edge was limited to the federal lease boundary.
 - The northern pit edge could extend into the historical Maybe Pit area to extract the remaining phosphate material left by the previous operator.
 - The west and east pit edges could cross the lease boundary. The pit limits outside the lease will be included in a permit modification process.
- NDR:
 - The northern pit edge was limited to the federal lease boundary and the state wildlife management area (WMA) boundary.
 - The southern pit edge was limited to the federal lease boundary.
 - The west and east pit edges could cross the lease boundary. The pit limits outside the lease will be included in a permit modification process.

Results of the pit optimization analysis included a range of pit sizes and shapes generated by varying the “Gross Margin available per P₂O₅ ton FOB Rail” value by small increments. Each pit shell can be evaluated based on a discounted cash flow. Golder and Itafos Conda reviewed the optimization results and selected the appropriate pit for both properties.

Preliminary Mine Designs

PEA level pit designs were completed for both the H1 and NDR deposits using the pit shells selected from the pit optimization and geotechnical parameters provided by Itafos Conda. Ultimate pit designs for H1 and NDR are provide below as Figure 24-1 and Figure 24-2.

The geotechnical parameters used for H1 and NDR pit designs are based on an analysis performed Call & Nicholas, Inc. (CNI) in 2015 and are summarized below in Table 24-2.

Table 24-2: H1 and NDR Geotechnical Parameters

Rock Type	Bench Width (ft)	Bench Height (ft)	Bedding Dip (°)	Bench Face Angle (°)	Inner-ramp slope Angle (°)
Unconsolidated	n/a	80	n/a	34	n/a
Chert	20	80	n/a	63	48
Phosphate Zone	20	80	n/a	63	48
Limestone	0	n/a	0-37	0-37	0-37
	30	80	35-45	35-45	34
	30	80	48-56	48-56	39
	30	80	56-53	56-63	45
	30	80	>63	63	48

Preliminary Overburden Stockpile Area (OSA) Design

Preliminary OSAs were designed for both H1 and NDR. Both pits assume utilizing the Maybe Canyon pits to handle the overburden from the early phases of mining. It is estimated approximately 12 Mbcy of NDR overburden will be placed in NMM, and approximately 14 Mbcy of H1 overburden will be placed in SMC. The remaining overburden will go into H1 and NDR as backfill. Material that cannot be directly placed into the Maybe pits or advancing development of the H1 or NDR pits will be over stacked as temporary internal OSAs or placed into temporary external OSAs. The temporary external OSAs are estimated at 12.8 Mbcy for H1 and 2.1 Mbcy for NDR. This material will be rehandled and placed in the final pit phases as part of final reclamation.

Figure 24-1: Preliminary NDR Ultimate Pit Design (Golder, 2019)

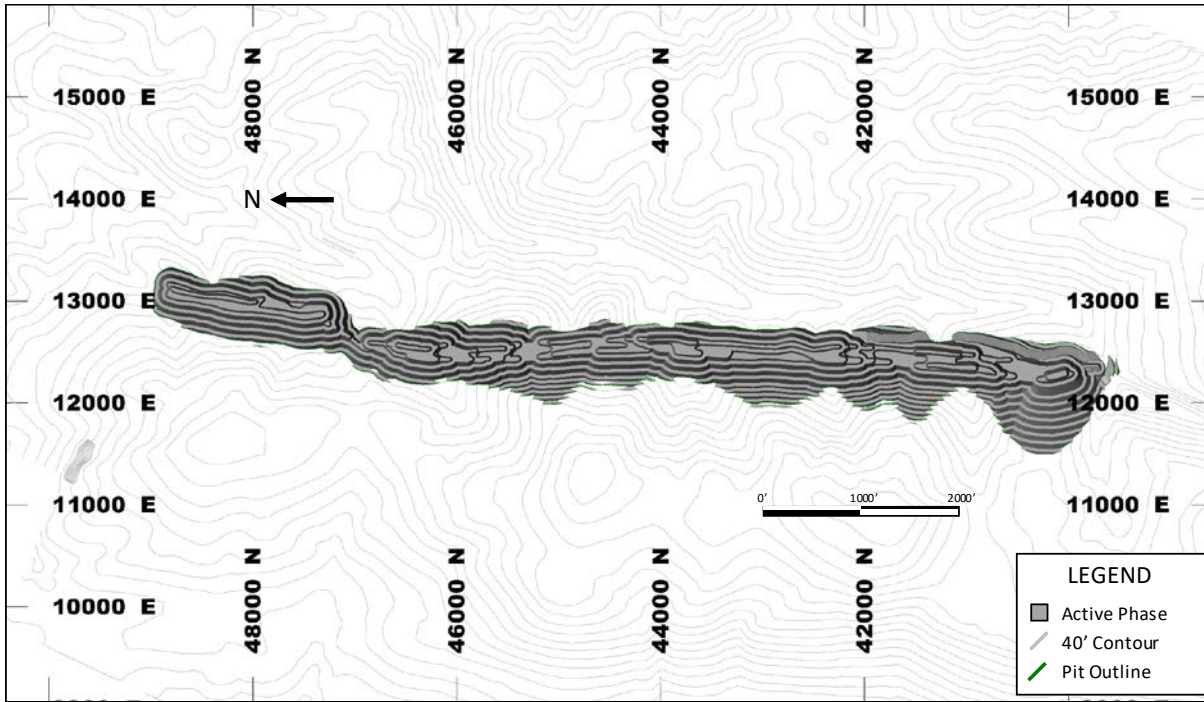
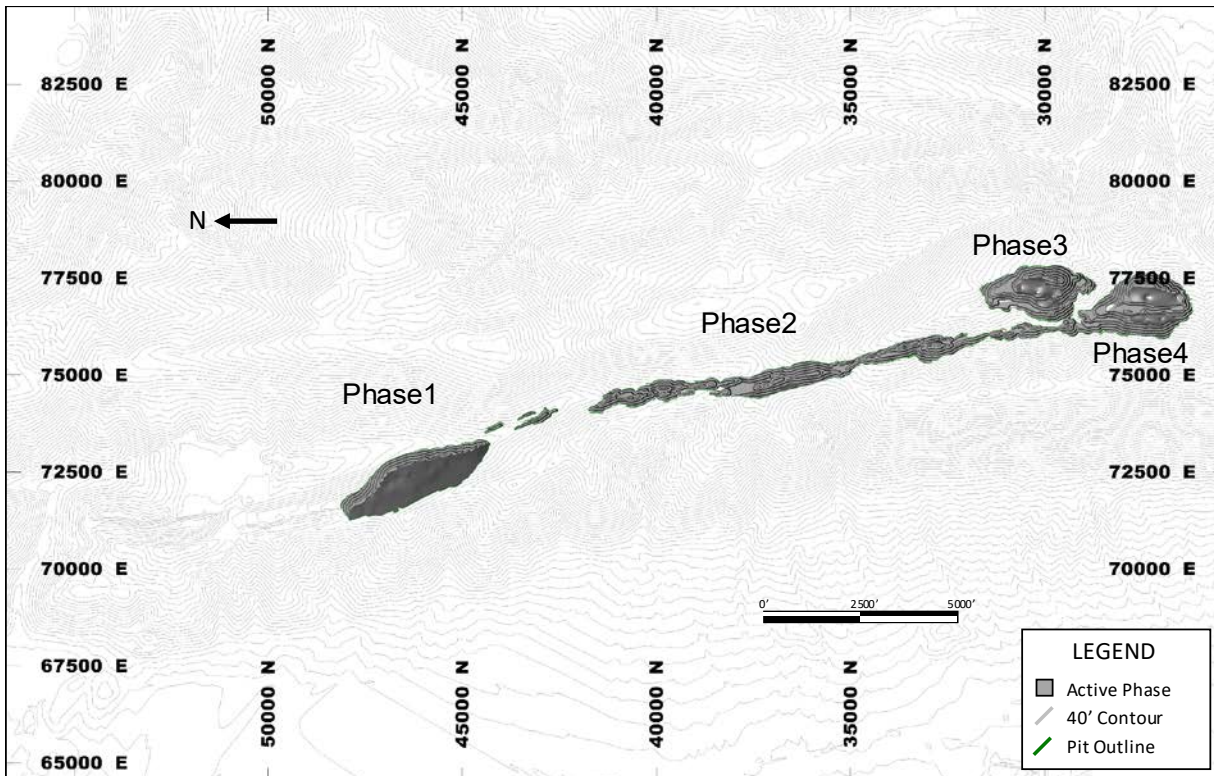

Figure 24-2: Preliminary H1 Ultimate Pit Design (Golder, 2019)



PEA Level Schedule and Economic Analysis

A PEA level schedule was developed to provide 548 Kt dry of contained P_2O_5 annually to the CPP. The PEA plan was developed to provide an uninterrupted supply of ore and maintain a stockpile inventory of about six months of feed. A summary of the mining schedule is provided as Figure 24-3. The PEA mine plan was also used to perform a high level analysis of the economic potential for the H1 and NDR deposits. The results of the economic analysis are provided below in Table 24-3.

Figure 24-3: Preliminary H1 and NDR Mill Feed Schedule

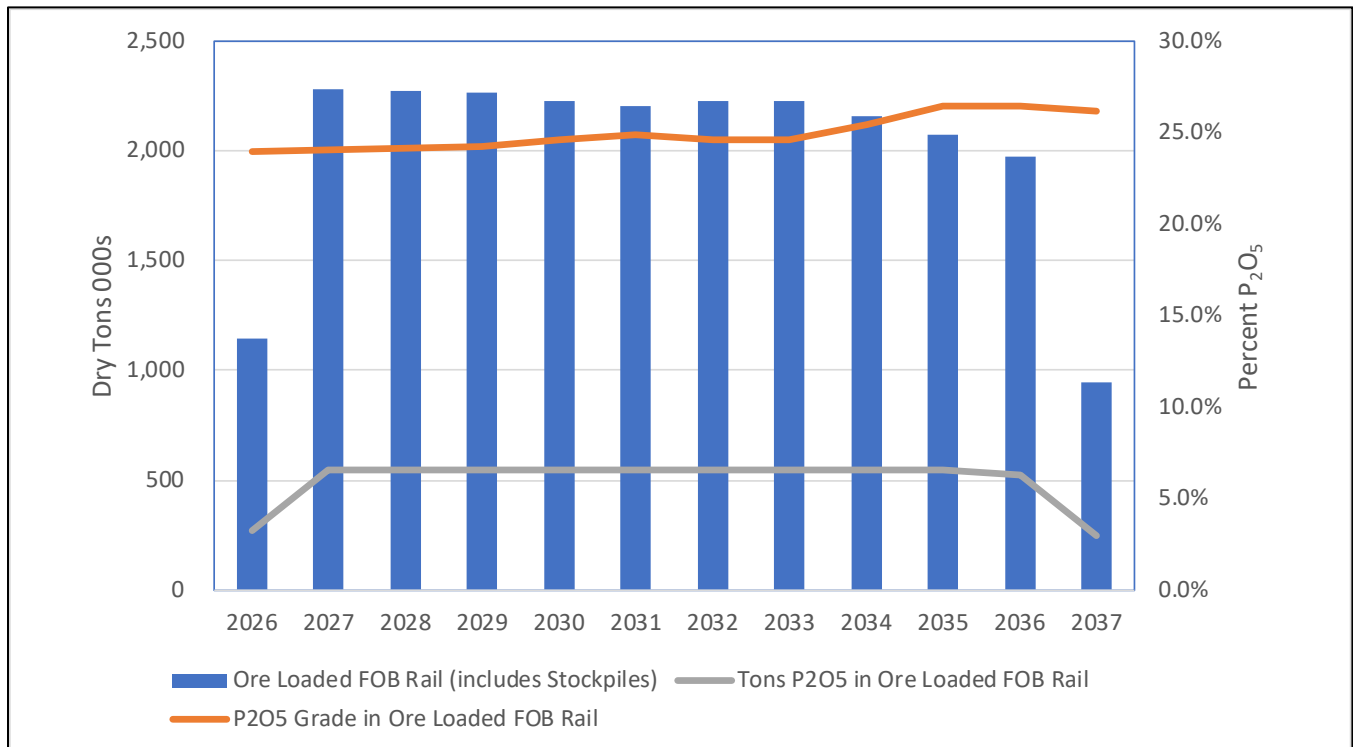

Table 24-3: Mine Plan Statistics and Economic Analysis

Item	Units	Totals or Avg.	2025	2026	2027	2028	2029	2030 to 2034	2035 to 2039	2040 to 2066
<u>Production</u>										
Waste Tonnage	short tons (wet) 000s	209,924	7,008	16,515	19,046	19,050	19,020	93,716	35,568	-
Waste Volume	bcy 000's	105,755	3,531	8,320	9,595	9,597	9,582	47,212	17,919	-
Tonnage Strip Ratio	bcy / short ton (wet)	4.0	4.9	4.2	3.8	3.8	4.0	4.0	3.9	-
Ore Moisture	percent	10%	10%	10%	10%	10%	10%	10%	10%	-
Ore Mined @ 10% Moisture	Tons (wet) 000s	26,655	723	1,977	2,535	2,528	2,421	11,866	4,605	-
Ore Mined (dry)	Tons (dry) 000s	23,989	650	1,779	2,282	2,275	2,178	10,679	4,145	-
P ₂ O ₅ in Ore Mined	Wt. % (dry)	25.0%	24.4%	23.9%	24.0%	24.2%	24.2%	24.9%	26.9%	0.0%
Ore Loaded FOB Rail (includes Stockpiles)	Tons (dry) 000s	23,989	-	1,145	2,280	2,269	2,266	11,040	4,990	-
P ₂ O ₅ Grade in Ore Loaded FOB Rail	Wt. % (dry)	24.9%	0.0%	23.9%	24.0%	24.2%	24.2%	24.8%	26.4%	0.0%
Tons P ₂ O ₅ in Ore Loaded FOB Rail	Tons (dry) 000s	5,976	-	274	548	548	548	2,740	1,318	-
<u>Mining Costs</u>										
Waste	\$ 000s	803,642	26,829	63,225	72,913	72,928	72,812	358,771	136,165	-
Ore	\$ 000s	157,382	3,833	10,739	14,095	14,377	14,073	72,613	27,653	-
Concurrent Reclamation Cost	\$ 000s	9,129	-	60	624	1,149	431	3,727	3,139	-
Royalty Cost	\$ 000s	41,080	1,091	2,930	3,766	3,798	3,630	18,309	7,556	-
Tipple and Stockpile Cost	\$ 000s	35,184	514	2,170	3,347	3,337	3,195	15,663	6,959	-
Total Mining Cost	\$ 000s	1,046,417	32,266	79,123	94,745	95,588	94,141	469,083	181,471	0
Total Cost per Ore Ton	\$/ton (wet)	39	45	40	37	38	39	40	39	-
Total Cost per Ton P ₂ O ₅	\$/ton P ₂ O ₅	175	0	289	173	174	172	171	138	0
<u>Final Reclamation & Closure Costs</u>										
Total Final Reclamation & Closure Costs	\$ 000s	83,411	0	0	0	0	0	16,340	54,456	12,615
<u>Capital</u>										
Capital Costs	\$ 000s	76,938	71,823	4,388	727	0	0	0	0	0
Change in Working Capital	\$ 000s	0	29,614	57,894	-34,057	1,083	-4,365	-13,587	-37,433	851
Total Capital	\$ 000s	76,938	101,437	62,282	-33,330	1,083	-4,365	-13,587	-37,433	851
<u>Margin</u>										
Final Recl. & Mine Closure Cost	\$ 000s	13,258	0	608	1,216	1,216	1,216	6,079	2,923	0
Risk Margin	\$ 000s	219,829	0	10,080	20,159	20,159	20,159	100,797	48,473	0
Total Cost of Ore	\$ 000s	1,329,572	32,266	89,810	116,120	116,963	115,516	592,299	266,597	0
Total Cost Of Ore (Transfer Price)	\$/ton P₂O₅	222	0	328	212	213	211	216	202	0
<u>Discounted Cash Flow Analysis</u>										
	Period	0	1	2	3	4	5	6-10	11-15	16+
Annual Cash Flows	\$ 000s	0	-101,437	-51,594	54,706	20,292	25,740	120,463	68,103	-13,466
Cumulative Cash Flow	\$ 000s	0	-101,437	-153,032	-98,326	-78,034	-52,294	90,300	656,595	122,806
Discounted Cash Flows	\$ 000s	0	-90,569	-41,131	38,938	12,896	14,606	48,829	18,627	-2,197
Internal Rate of Return	12%									

The mine operating costs were developed based on the unit costs developed for the RVM with some adjustment for reduced ore haul distances. ARO costs were developed based on studies performed on the RCM with appropriate adjustment for H1 and NDR conditions. Capital costs for H1 and NDR included:

- Refurbishment of the rail line
- Refurbishment of existing tipples or construction of a new tipples (new tipples is the base case for economics)
- Refurbishment of the maintenance shop
- Road work to widen existing roads for mining equipment access
- Exploration drilling
- Metallurgical test work
- Power supply
- Stream alteration
- Permitting and other studies
- Water control structures
- Contractor mobilization
- Preparation of growth media stockpile areas

Based on the preliminary mine plan and cost estimate, the H1 and NDR deposits justify further evaluation as a potential replacement source for the Conda ore feed. Golder recommends that Conda perform a PFS Level study with optimization studies for:

- Owner operated mining
- Full integration with RVM and LCM ore supply and reclamation activities
- Upgrades to the wash plant to accommodate the H1 and NDR mineralization characteristics

24.2 Itafos Conda Phosphate Plant

The Itafos Conda Phosphate Plant (CPP) started operations in 1965. Since then, the CPP has used 7 different local mines to supply the plant with phosphate ore. All of the mines are within 50 miles of the CPP and historically ore has been transported to the plant predominantly via rail.

Since starting operations, the CPP has been modified to treat the mined ore in support of the phosphoric acid plant. In 1967 a wash plant and 2 calciners were constructed and commissioned on the site, and from 1967 through late 2001, the washed ore was calcined to remove organics prior to processing in the phosphoric acid plant. In 2001 a new Prayon reactor was installed, replacing the original reactors and calcination of the washed ore ceased late that year.

Current CPP Process and Facilities

The CPP consists of the following plant, major facilities and operations.

Phosphate Ore Supply and Plant Stockpile

Phosphate ore (fluorapatite) is mined, transported to a loading tippel, and then loaded into rail cars for transport from Itafos' captive mines to the CPP. The ore is mined year-round, but only shipped between late March and November due to winter railroad track conditions. This necessitates the building and use of a local ore stockpile at the CPP site for use over the winter months.

Wash Plant

The Wash Plant prepares the ore for use by the phosphoric acid plant. The ore is screened, with the smaller ore going to a sump and oversize material crushed prior to reporting to the sump. At the sump, the ore is slurried and pumped to a hydrocyclone bank to separate slimes from the ore. The hydrocyclone operation has the net effect of raising the % of P₂O₅ in the underflow, which allows for an easier reaction later in the process. The hydrocyclone underflow is then sent to ball mills for further size reduction. Finally, the washed ore is sent to a holding tank for use by the phosphoric acid plant.

Phosphoric Acid Plant

The phosphoric acid plant uses a Prayon Mark IV digester to react the washed ore with sulfuric acid, producing a phosphoric acid and phosphogypsum slurry. The overall reaction is:

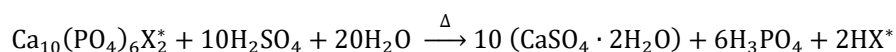

* Note: X – Typically Fluorine (F) but can be Chlorine (Cl) or a hydroxyl group (OH)

The slurry is sent to one of several filters to separate the phosphogypsum (gyp), a waste product, from the phosphoric acid. The liquid phosphoric acid is the starting point for the rest of the process and will end up as one of three (3) final products:

- Super Phosphoric Acid (SPA) is liquid phosphoric acid with a P₂O₅ content of 69-70%.
- Merchant grade phosphoric Acid (MGA) is clarified (<0.3%solids) 54% Phosphoric acid.
- Monoammonium Phosphate (MAP) is a dry granular fertilizer, which contains both Nitrogen and Phosphate nutrients.

The process starts with evaporating about 1/3 of the water out of the phosphoric acid made in the reactor. This occurs in a forced circulation evaporator, which uses steam to heat the acid and vacuum to lower the boiling point of the acid, thus removing the water as efficiently as possible. This process raises the acid from 28% to 42% P₂O₅. Some of the 42% phosphoric acid is sent to the granulation plant where it is reacted with ammonia to form MAP. The MAP is screened for size and sent to the dry shipping warehouse for storage and loading for delivery to our customers.

The balance of the 42% P₂O₅ phosphoric acid is sent to evaporators where another 1/3 of the water is removed. This increases the P₂O₅ content to 52-54%. Some of this will be aged, settled for solids removal, and sold as MGA. The rest of the acid will continue to the SPA evaporators. The SPA evaporators remove the remaining water and convert some of the orthophosphoric acid into polyphosphoric acid, which has the effect of further raising the % P₂O₅ in the phosphoric acid. The SPA acid is then sent to a series of tanks for organic removal, aging and storage. Finally, the SPA is filtered to remove impurities, such as magnesium, and loaded into rail cars or trucks for transport.

Sulfuric Acid Supply

For every ton of P₂O₅ made about 3 tons of sulfuric acid is needed. The supply of sulfuric acid comes from two sources. The first is long term contracts from sulfuric acid producers that ship sulfuric acid to the plant in rail cars. These are unloaded and stored in the sulfuric acid tank farm. The second is to produce sulfuric acid on site. Molten sulfur is brought in by rail car and off loaded into a sulfur pit and sulfur storage tank. The sulfur is burned and converted into sulfuric acid in the sulfuric acid plant and then pumped to the sulfuric acid tank farm where it combines with the purchased sulfuric acid. The tank farm continuously provides the phosphoric acid plant with the sulfuric acid required to maintain production.

Phosphogypsum (Gyp) Stacks

The phosphogypsum produced in the reactor is sent to a gyp stack. The gyp stack is continuously built until the design height/volume is reached at which point the stack will be closed and remediated. Another gyp stack will be built and in use prior to the first one reaching end of life. There is currently one inactive gyp stack, two operational gyp stacks, and one gyp stack under construction.

Tailings Pond

There is a tailings pond on site that collects the wash plant slimes/rejects for settling. Decanted water from the pond is reused in the wash plant.

CPP Permits and Environmental Liabilities

The CPP, including all mineral processing activities, complies with all applicable Federal and State laws and regulations established to prevent unnecessary or undue degradation to the environment.

Itafos holds Tier I Permit No. T1-2016.0015 for the CPP that was issued by the Idaho DEQ on January 30, 2019 and expiring January 30, 2024. The Tier I operating permit (also known as a Title V operating permit) consolidates all applicable federal, state, and local air requirements for an air pollution source into one federally enforceable document.

Itafos Conda LLC is also a “self-designated” large quantity generator under the Resource Conservation and Recovery Act (RCRA). Although no permits are required, Itafos complies with all waste stream reporting required of the CPP. Idaho DEQ serves as the lead agency in Idaho under RCRA. All spills, leaks and containments at the CPP are handled under the general rules and regulations of RCRA.

Itafos Conda LLC operates an onsite construction and demolition (C&D) landfill for certain designated and acceptable wastes such as construction and demolition debris, which typically consists of roadwork material, excavated material and demolition waste. C&D landfills do not receive hazardous waste or industrial solid waste, unless those landfills meet certain standards and are permitted to receive such wastes. C&D landfills are under the regulatory oversight of the DEQ and Idaho public health agencies. All municipal solid wastes from the CPP are hauled to the Caribou County Landfill.

Reclamation and Closure Bonds

Itafos Conda LLC has the following bonds in place related to the CPP: 1) Closure Bond with the Idaho Department of Water Resources for closure of the ore process tailing pond in the amount of \$808,500; and 2), Reclamation Bond in the amount of \$130,000 with the Idaho Department of Lands for the area designated for borrow material.

Financial assurance instruments for reclamation and closure of the gypsum (Gyp) stacks may be required and various options are currently being considered.

Asset Retirement Obligations

In connection with the acquisition of Itafos Conda from subsidiaries of Agrium, Inc (“Agrium”), a wholly-owned subsidiary of Nutrien Ltd., Agrium agreed to assume full liability for all environmental and asset retirement obligations relating to the pre-closing operations of Itafos Conda. As current owner and operator of Itafos Conda, the Company will be liable for certain environmental and asset retirement obligations relating to the post-closing operations of Itafos Conda. Accordingly, the Company recognizes the present value of its respective share of environmental and asset retirement obligations relating to the post-closing operations of Itafos Conda. As at September 30, 2019, Itafos Conda had environmental and asset retirement obligations of \$36.5 M.

24.3 Exploration Targets

The following areas are potential exploration targets located near the Property controlled by Itafos, see Figure 23-1 for the locations of these targets.

The Freeman Ridge (FR) Lease is located about two miles east of the H1 Lease and located on USFS surface-owned land. The FR Lease phosphate zones run along both sides of FR to the east of Upper Diamond Creek and to the west of Sage Valley. The FR Lease extends approximately five miles in length with steeply dipping phosphate beds. Previous exploration drilling on the FR Lease was conducted in 1967, with only limited data collected from this program.

The Husky 2 (H2) Lease ID-007942 abuts the FR Lease to the south and the USFS is the surface landowner. The H2 Lease is approximately four miles long, and the deposit is steeply dipping. The steep anticlinal fold explains the varying structural thickness of the Meade Peak Member. Exploration drilling in the H2 Lease was conducted by International Minerals and Chemical Corporation in 1975 where 23 drill holes were reportedly completed.

Agrium conducted some preliminary geologic surface mapping and exploration planning on FR and H2 in 2012 and 2013.

The Husky 3 (H3) Lease ID-007239 abuts the Dry Ridge Federal Lease I-07238 held by Solvay USA Inc. which abuts the south end of the H1 Lease. H3 is approximately 3 miles south of H1 and approximately 2.5 miles long. The Husky 4 (H4) Lease ID-007240 abuts the south end of the H3 Lease and is approximately 2 miles long.

In addition, Itafos holds ten more leases located within a reasonable distance to the CPP. The potential for each lease will be evaluated in the future.

25.0 INTERPRETATION AND CONCLUSIONS

This Item presents the interpretation and conclusions of the TR Authors.

25.1 Geology and Mineral Resource Estimates

Regarding geology and Mineral Resource estimation, the Golder QP has the following interpretations and conclusions for the five projects presented in this TR:

- Golder's review of data collection methods and independent data verification process has confirmed the following:
 - Data were collected under the supervision of senior Company geologists and engineers that meet the definition of Qualified Persons under NI 43-101.
 - The data appear to have been obtained using appropriate industry standards.
 - The data compiled in digital tabular format appears to be free of errors or omissions relative to original source files (descriptive logs, laboratory certificates, wireline logs and so forth).
 - The data appears to be a reliable and representative of the geology and grade data for each of the five projects and are suitable for the development of geological models and preparation of Mineral Resource estimates.
- The development of resource pits for the Itafos Conda projects and high-level cost and pricing analysis for the PH Project, using reasonable cost and pricing parameters and assumptions, support reasonable prospects for future economic extraction for each of the five projects.
- Golder has estimated categorized Mineral Resources, in accordance with the definitions presented in NI 43-101, for each of the five projects addressed in this TR. A summary of the Resource Estimates is presented in Item 14 of this TR.
- The current estimates summarized in Item 14.0 of this TR reflect increases in Mineral Resources for RVM, LCM, NDR, and H1 relative to the previous internal Company estimates discussed in Item 6.0. The increases are attributable to the following:
 - Less conservative modeling methodology
 - Revised interpretation of stratigraphy and structure, resulting in localized volumetric changes to the modeled units
 - A more robust grade data evaluation and interpolation process.
 - Updated current resource pit shell constraints.
- The current PH estimate summarized in Item 14.0 of this TR reflects a slight decrease in Mineral Resources relative to the previous publicly disclosed Mineral Resources for PH (Agapito Associates Inc., 08 July 2013). The slight decrease is attributable to the following:
 - Subtle differences in the structural modeling and grade modeling methodology

- Opportunities exist to further upgrade current categorization of Mineral Resources (i.e., potential to upgrade Inferred to Indicated, Indicated to Measured) as well as to add additional resource tons currently not included in the estimates. The opportunities for additional future resources include but are not limited to the following:
 - Along strike and down dip (at depth) of existing delineated resources for the Itafos Conda projects
 - Potential UPZ and LPZ mineralization in the overturned limb at PH
 - Potential vanadium mineralization below the UPZ at PH

Golder has identified the following risks and opportunities relating to geological modeling and mineral resource estimation for the five projects presented in this TR:

- Risk relating to the potential impact of RC drilling on grade, to be assessed via a comparison of core versus RC drill hole grade data when available from the 2019 core drilling program
- Risk relating to the potential impact of positional reliability of drill hole intercepts in some Itafos Conda projects drill holes due to lack of downhole positional survey data. Future drilling programs should include downhole positional surveys to allow for evaluation of the impacts of drill hole deviation on the spatial positioning of downhole data used for modeling and estimation purposes.
- Risk relating to the assignment of average densities from limited number of samples introduces risk to the geological model and mineral resource estimation process as it assumes that there will be minimal variability in density within each of the units across their spatial extents within the individual deposits.
- Risk relating to the reliability of topographic elevation data and models for NDR and H1.
- Potential impact on CPP process with higher MgO values in H1.
- Risk relating to the dewatering estimates and costs at PH.
- Risks and opportunities relating to the need to assess metallurgical data for the NDR and H1 projects to understand impacts on changes in P₂O₅, MgO, and other key grade parameters as well as potential impacts from changes to the CPP process.
- Opportunities to revisit minimum P₂O₅ grade requirements pending evaluation of alternative process methods at CPP.
- Opportunity for potential additional phosphate resources not currently included in the estimates of Mineral Resources (i.e., overturned limb at PH, vanadium zone at PH, along-strike and down-dip opportunities at NDR and H1).

25.2 Mining and Mineral Reserve Estimates

Regarding Mining, the Golder QP has the following interpretations and conclusions for the RVM and the LCM for the Mineral Reserve Estimates presented in this TR:

- Golder's review of these operations indicates:
 - The mining operation has a LOM of 6.5 years after which the stockpiles can continue to supply the CPP with sufficient ore for approximately six months.
 - There is a total of 14.36 Mst (dry) of mineable ore reserves including 12.93 Mst (dry) of ore in the RVM and LCM mining operations and 1.43 Mst (dry) in stockpile inventory.
 - The implemented equipment is suitable for mining in this type of environment.
 - Golder recommends that the current reconciliation methodology be reviewed and revised, as appropriate, to support the operation.
- Golder used information provided by Itafos Conda as well as material gathered from site visits to prepare the following:
 - A pit optimization analysis, which included a wide range of economic pit shells:
 - Based on the assumptions used for the pit optimization and the existing mining method, Golder and Itafos Conda selected the agreed-upon pit shells for which to base the mine designs.
 - Phase pit designs and overburden storage designs closely follow the mining methods employed at Itafos Conda operations.
 - A production schedule.
- Golder identified the following risks and opportunities, which relate to mining and the Mineral Reserve estimation:
 - Risks related to geotechnical uncertainties.
 - Risks related to dewatering and heavy inflow of surface water.
 - Opportunities to reduce haulage and re-handle costs by optimizing OSA locations.
 - Opportunities to increase reserves, if mining below the water table proves economic.
 - Opportunities to increase reserves by preparing a PFS on the H1 and NDR projects.

26.0 RECOMMENDATIONS

26.1 Geology and Mineral Resource Estimation Recommendations

Regarding geology and Mineral Resource estimation, the Golder QP's recommendations include the following:

- Update the H1 and NDR Project models with data from the 2019 metallurgical drilling program once results are available.
- Evaluate additional drilling needs with consideration towards additional quality control/verification purposes for areas reliant on older vintage drilling such as NDR (legacy drilling from 1989 and 1990) and the South Maybe Canyon drilling (legacy drilling performed on behalf of and results supplied by a competitor) at the north end of the H1 Project. Additional drilling at NDR should also target collecting core to perform project specific metallurgical test work. See below for a high-level cost estimate for recommended drilling.
- Evaluate additional drilling opportunities to expand resource inventory along strike and down dip (at depth) of the current delineated resources
- As part of any future exploration work, it is recommended to perform additional external check assays for Itafos Conda projects analytical data performed primarily at CPP
- As part of future exploration work perform downhole positional surveys on drill holes at Itafos Conda projects
- Perform additional density and moisture data for all projects to develop more robust default values
- Acquire improved topographic data to develop new topographic models for NDR and H1
- Perform evaluation of potential for mineralization within the overturned limb at PH
- Perform evaluation of the potential vanadium zone at PH

As stated above, Golder recommends additional drilling at H1 and NDR as follows:

- H1 Drilling Recommendations:
 - Approximately ten core drill holes twining historical SMCM drilling conducted by operators other than Conda and its predecessors. The purpose of this program is to evaluate the reliability and representativeness of the historical SMC drilling used in the north end of the H1 model.
 - Depending on the results of the 2019 H1 drilling program, there may be further opportunities for both resource expansion and infill drilling to upgrade resource classification, especially in the southern part of H1 where the structure is more complex. Based on initial evaluations this additional drilling could include up to 40 drill holes.
 - All proposed drilling should include a robust analytical QA/QC program of standards, blanks and duplicate/replicate analyses. Drill collars should be surveyed by the Itafos Conda mine surveying department or a professional surveyor and downhole directional surveying should be considered.
 - Estimated cost for the ten core drill holes in the SMCM area is approximately \$1.5 M. Estimated cost for drilling up to 40 drill holes for resource expansion and infill drilling in the H1 Project, pending evaluation of results of the 2019 program, is approximately \$6 M.

- NDR Drilling Recommendations:
 - Approximately ten core drill holes spatially distributed across the NDR Project. The purpose of this program is to evaluate the reliability and representativeness of the 1989 and 1990 Conda drilling as well as to collect project specific metallurgical data for further studies and estimates.
 - All proposed drilling should include a robust analytical QA/QC program of standards, blanks and duplicate/replicate analyses. Drill collars should be surveyed by the Itafos Conda mine surveying department or a professional surveyor and downhole directional surveying should be considered.
 - Estimated cost for these five core drill holes is approximately \$1.5 M.

26.2 Metallurgy Recommendations

In regard to metallurgy, recommendations include the following:

- Characterization studies on RVM, LCM, H1, and NDR representative samples of each project are necessary. These studies should include beside the regular chemical analyses; screen assays, mineralogical, and QEMSCAN studies. These last studies should concentrate on dolomite and carbonate minerals with special detail on their morphology, primary particles size, and crystal structure.
- Optimization studies on horizontal scrubbing should be carried out not only taking into consideration particle-particle interactions, but also rheological behavior. The purpose should be to maximize dolomite and fine silica rejection.
- Crushing of the +1.375-inch material (+34,925 μm) should be revisited. Apparently, the use of bed-comminution mechanism instead of impact mode should be explored to take advantage of selective comminution of dolomite.
- Attrition scrubbing and optimization studies of this unit operation on the -0.375-inch size fraction (-9,525 μm) should be conducted to determine if rejection of dolomite and SiO_2 may be sufficient using attrition scrubbing to upgrade the washed product to specs (>30% P_2O_5 and < 0.60% MgO).
- Improve process control for the Wash Plant should be considered. For example, it could include moisture determination (using microwaves or infrared) with the weight meters for both the phosphate feed and the washed product, continuously measuring dry tons. In addition, solids content or density meters of the tailings stream (overflow of the Krebs gMax-20 hydrocyclones) should be considered in conjunction with chemical analysis to determine tailings P_2O_5 losses. This tailings controls should be complemented with pump flowmeters.
- Develop the adequate procedure for the flotation feed preparation based on optimized results of the horizontal scrubbing, crushing, and attrition scrubbing studies. For this purpose, sizing must be investigated at the corresponding cutting meshes, as determined by the characterization studies, before and after classification at 325 mesh (44 μm). Thus, the actual size fraction to be submitted to flotation could be determined.
- If flotation is required, grinding of the 0.375 inch x 48-mesh size fraction (9525x300 μm) to minus 48 mesh (-300 μm) must be studied to define the grinding parameters and best operating conditions.

- Flotation studies at the required size fraction should be carried out. These studies should include reagents types and dosages necessary, pH, solids content, conditioning techniques, and flotation cell types and operating conditions.
- Pilot plant tests for H1 and NDR Phosphate Ores must be considered once the final flowsheet is determined.

26.3 Mining

- Prepare a PFS level study on the H1 and NDR projects once the metallurgical information becomes available.
- Evaluate the potential for lowering the cutoff grade and increasing reserves.
- Develop and perform additional reconciliation studies as mining progresses in RVM and incorporate the results into future mining studies.

27.0 REFERENCES

27.1 Acronyms and Abbreviations

Acronym/Abbreviation	Definition
\$	United States Dollars
% C _s	Percentage of Critical Speed
°	degree
µm	micrometer
2D	2-dimensional
3D	3-dimensional
AIF	Annual Information Form
Al	Aluminum
Al ₂ O ₃	Aluminum oxide
AOC	Administrative Order on Consent
APP	ammonium polyphosphate
APPC	Agricultural Potassium Phosphate Company of California
ARO	asset retirement obligation
ASAOC	Administrative Settlement Agreement and Order on Consent
B	Billion
BLGC	Bear Lake Grazing Company
BLM	Bureau of Land Management
BMP	best management practice
calcite	calcium carbonate
CaO	Calcium oxide
CAPEX	Capital Expenditure
CERCLA	Comprehensive Environmental Response, Compensation, and Liability Act
CIB	Center Interburden
CIM	Canadian Institute of Mining and Metallurgy and Petroleum
CIMDS	CIM Definition Standards on Mineral Resources and Reserves
CNI	Call & Nicholas, Inc.
CO	Consent Order
CPO	Cond Phosphate Operations
CPP	Conda Phosphate Plant
Cr-Mo	Chromium Molybdenum
CRU	CRU International Ltd.
DAP	Diammonium phosphate
dolomite	magnesium carbonate
EA	environmental assessment
EIS	Environmental Impact Statement
EMP	Environmental Monitoring Plan
ESI	Earth Sciences, Inc.
Fe ₂ O ₃	Iron Oxide

Acronym/Abbreviation	Definition
FOB	free-on-board
FR	Freeman Ridge
ft	feet
ft ²	square feet
FWM	Foot Wall Mud
gamma	natural gamma ray logs
GM	Growth Media
Golder	Golder Associates Inc.
gpm	gallons per minute
H1	Husky 1
H2	Husky 2 Exploration Target
H3	Husky 3 Exploration Target
HP	Horsepower
HPGR	high pressure grinding rolls
HWM	Hanging Wall Mud
IBLA	Idaho Department of Interior Board of Land Appeals
ICP-OES	Inductively coupled plasma - optical emission spectrometer
ID	Idaho
ID ²	Inverse Distance Squared
IDEQ	Idaho Department of Environmental Quality
IDL	Idaho Department of Lands
IPDES	Idaho Pollutant Discharge Elimination System
Itafos Conda	Itafos Conda LLC
Jacobs	Jacobs Engineering S.A.
Kiewit	Kiewit Corporation
KPLA	Known Phosphate Leasing Area
kt	kiloton
kV	kilovolt
kwh/t	kilowatt hour/short ton
LCM	Lanes Creek Mine
LEA	Lease Exchange Agreement
LG	Lerchs Grossman
LOI	Loss on Ignition
LOMP	life-of-mine plan
LPZ	lower phosphate zone
M	Million
Major	Major Drilling Group International, Inc
MAP	monoammonium phosphate
Mbcy	Million bank cubic yard
MDW	mine drainage water
Meade Peak	Meade Peak Phosphatic Shale Member

Acronym/Abbreviation	Definition
MER	Minor Elements Ratio
MGA	merchant grade phosphoric acid
MgO	Magnesium oxide
mi	mile
MLA	Mineral Leasing Act
MRC	Metals Reserve Company
MRP	Mine and Reclamation Plan
MSSO	MineSight Strategic Optimizer
Mt	Million short ton
Mtpa	million short tons per annum
NDR	North Dry Ridge
NEPA	National Environmental Policy Act
NGO	non-governmental organization
NI	National Instrument
NMM	North Maybe Canyon Mine
NOLA	New Orleans, Louisiana
NPV	net present value
N-SOVB	Non-Selenium Overburden
OK	Ordinary Kriging
OPEX	Operational Expenditure
P ₂ O ₅	Phosphorus pentoxide
PAP	Phosphoric Acid Plant
PEA	preliminary economic assessment
PFS	pre-feasibility study
PH	Paris Hills Project
PHA	Paris Hills Agricom Inc.
PLC	Programmable Logic Controller
POC	Points of Compliance
psi	pounds per square inch
QA/QC	Quality Assurance/Quality Control
QP	Qualified Person
RC	reverse circulation
RF	revenue factor
RFC	Reconstruction Finance Corporation
RMP	RMP Resources, Corp.
ROD	Record of Decision
ROM	run-of-mine
rpm	revolution per minute
RQD	Rock Quality Determination
RVM	Rasmussen Valley Mine
SGS Denver	SGS laboratory in Denver, Colorado

Acronym/Abbreviation	Definition
Simplot	J.R. Simplot Company
SiO ₂	Silicon dioxide
SMCM	South Maybe Canyon Mine
Solar	Solar Development Company, Ltd.
SPA	superphosphoric acid
SRM	South Rasmussen Mine
st/ft ³	short tons per cubic foot
SUP	special use permits
SOVB	Selenium Overburden
SWPPP	Stormwater Pollution Prevention Plan
tds	total dissolved solids
tpd	tons per day
tph	tons per hour
TR	Technical Report
TSX-V: IFOS	TSX Venture Exchange
UAO	Unilateral Administrative Order
UPRR	Union Pacific Railroad
UPZ	upper phosphate zone
USA	United States of America
USACE	United States Army Corps of Engineers
USEPA	United States Environmental Protection Agency
USFS	US Department of Agriculture Forest Service
USGS	United States Geological Survey
UT	Utah
variography	semi-variogram analysis
VWP	vibrating wire piezometer
WMA	Wildlife Management Area
wt	wet tons
WV	Wooley Valley
Wyodak	Wyodak Coal Manufacturing Company

27.2 Works Sited

- AAI (Agapito Associates, Inc.) Gilbride, Leo J., P.E., Santos, Vanessa, P.G., Skaggs, Gary L., P.E., P.Eng., Patton, Susan B., Ph.D., P.E., Dursterler, Eric, P.E., C.F.M. 2013. (dated 18 January 2013, Restated 08 July 2013. (AAI Ref. 758-08)). *Amended and Restated NI 43-101 Technical Report - Paris Hills Phosphate Project, Bloomington, Idaho, USA, prepared for Stonegate Agricom Ltd.*, Grand Junction, CO, USA: AAI (Agapito Associates, Inc.).
- Agapito Associates Inc. (08 July 2013). *Amended and Restated NI 43-101 Technical Report, Paris Hills Phosphate Project*. Bloomington, Idaho, US: prepared for Stonegate Agricom Ltd.
- Agrium Conda Phosphate Operations. (2011, January). *Rasmussen Valley Mine Project, Mine and Reclamation Plan, Revision 1*. Retrieved from <https://eplanning.blm.gov/epl-front-office/eplanning/planAndProjectSite.do?methodName=renderDefaultPlanOrProjectSite&projectId=48240>
- Agrium Conda Phosphate Operations. (2013, March 1). *Freeman Ridge / Husky 2 Exploration Plan of Operations - Letter to USDI Bureau of Land Management*.
- Agrium Conda Phosphate Operations. (September 2014). *Lanes Creek Mine, Operating and Reclamation Plan*. Soda Springs, Idaho.
- Agrium Nutrients. (n.d., Historical Plant Description). *Historical Plant Description*. Agrium Nutrients.
- Agrium/Nu-West. (June 2014). *Husky 2 / Freeman Ridge Internal Estimate of Resource*.
- Altschuler, Z. S. V. . (1958). *Geochemistry of uranium in apatite and phosphorite*.
- Alumet Company. (1978, May 31). *Mine and Reclamation Plan: Lanes Creek Mine – The First Two Years of Operation*.
- Alumet Company. (1979, April 2). *Amended Lanes Creek Mine and Reclamation Plan*.
- CIM Standing Committee on Reserve Definitions. (Nov. 27, 2010). *CIM Definition Standards - for Mineral Resources and Mineral Reserves*. Adopted by CIM Council.
- CRU. (2019, August 2). *Conda Phosphate Study*, prepared for Itafos. Chancery Lane, London, United Kingdom: CRU (CRU Consulting, a division of CRU International Limited).
- EPA. (Basic Information About Landfills). *Basic Information About Landfills*. Retrieved from <https://www.epa.gov/landfills/basic-information-about-landfills>
- Eriez Flotation Division/USA. (August 2, 2019, pp. 28). *Studies on Feed Preparation and Flotation Response Evaluation of an Idaho Phosphate Ore, Laboratory Testing*. Final Report (Redacted Version) SAN 20669 MTR 18-226 (Service Agreement Q2 18254_R3).
- Fenneman, Nevin M. (January 1917). *Physiographic Subdivision of the United States*. Proceedings of the National Academy of Sciences of the United States of America.
- Fertoz. (2013, December 10). *Fertoz acquires the Dry Ridge Phosphate Project in Idaho, USA*. Retrieved from <https://www.fertoz.com/wp-content/images/1286996.pdf>

- Fertoz. (2014a, February 19). *Fertoz receives operating rights to Dry Ridge Phosphate Project - Media Release*. Retrieved from <https://www.fertoz.com/wp-content/images/FTZ%2019022014.pdf>
- Fertoz. (2014b, July 24). *Fertoz Limited Dry Ridge Project Progress Report - Media Release*. Retrieved from <https://www.fertoz.com/wp-content/images/1347031.pdf>
- Haley & Aldrich. (February 2015). *Lanes Creek Operating and Reclamation Plan*. Caribou, Idaho: Agrium Conda Phosphate Operations.
- Haley & Aldrich. (September 25, 2013.). *Amendment to Mine and Reclamation Plan RP509 (S00509), Lanes Creek Mine, Caribou County, Idaho*.
- Hein, J. R. . (2004). *Preface*. Handbook of Exploration and Environmental Geochemistry.
- Hein, J. R., McIntyre, B. R., Perkins, R. B., Piper, D. Z., & Evans, J. G. . (2004). *Chapter 14 Rex Chert member of the permian phosphoria formation: Composition, with emphasis on elements of environmental concern*. Handbook of Exploration and Environmental Geochemistry, 8, 399–426.
- Huntsman Advanced Polymers and Wells Cargo Corporation. (2010). *North Maybe Mine West Ridge, Unilateral Administrative Order*.
- Idaho Department of Environmental Quality (DEQ). (2004). *Area Wide Risk Management Plan: Removal Action Goals and Objectives and Action Levels for Addressing Releases and Impacts from Historic Phosphate Mining Operations in Southeast Idaho*. Retrieved from <https://www.deq.idaho.gov/media/856749-selenium-project-area-wide-risk-management-plan-0204.pdf>
- Idaho Department of Environmental Quality (DEQ). (2008). *Lanes Creek Mine Preliminary Assessment Report*. Retrieved from http://deq.idaho.gov/media/558523-_newinternet_waste_data_reports_mining_waste_lanes_creek_mine_pa_0708.pdf
- Idaho Department of Environmental Quality (DEQ). (Landfills in Idaho). *Landfills in Idaho* . Retrieved from <https://deq.idaho.gov/waste-mgmt-remediation/solid-waste/landfills.aspx>
- Idaho Department of Environmental Quality (DEQ). (Letter). *Letter*. Retrieved from <http://deq.idaho.gov/media/60182550/itafos-conda-permit-0119.pdf>
- Idaho Department of Environmental Quality (DEQ). (Pending 2019). *North Dry Valley Mine Preliminary Assessment, Caribou County, State of Idaho*.
- Idaho Department of Environmental Quality (DEQ). (Permits Issued). *Current Permits Issued*. Retrieved from <http://deq.idaho.gov/permitting/issued-permits/?records=10&type=all&sort=nameAscending>
- Idaho Department of Environmental Quality (DEQ). (Statement of Basis). *Statement of Basis* . Retrieved from <http://deq.idaho.gov/media/60180892/nu-west-agrium-soda-springs-ptc-statement-1117.pdf>
- Idaho Department of Environmental Quality (DEQ). (Tier 1 Air Qual. Ops. Permit). *Tier I Air Quality Operating Permit*. Retrieved from <http://deq.idaho.gov/permitting/air-quality-permitting/tier-i/>
- Idaho Department of Environmental Quality (DEQ). (Tier 1 Application). *Tier 1 Application* . Retrieved from <http://deq.idaho.gov/media/60182411/itafos-conda-soda-springs-t1-application-1218.pdf>

- Idaho Department of Environmental Quality (DEQ). (Tier 1 Ops. Permit). *Tier I Operating Permit; Permittee: Itafos Conda, LLC (Facility No. 029-00003), 3010 Conda Road, Soda Springs, Idaho; Permit No. T1-2016.0015 / Project No. 61693*. Permit Issued: January 30, 2019 and Permit Expires: January 30, 2024.
- Idaho Department of Environmental Quality (DEQ). (Tier 1 Permit). *Tier 1 Permit*. Retrieved from <http://deq.idaho.gov/media/60182409/itafos-condasoda-springs-t1-permit-1218.pdf>
- Idaho Department of Environmental Quality (DEQ). (Tier I Statement of Basis). *Tier I Statement of Basis* . Retrieved from <http://deq.idaho.gov/media/60182551/itafos-conda-statement-0119.pdf>
- Idaho Department of Environmental Quality (DEQ). (Transfer of Ownership). *Transfer of Ownership* . Retrieved from <http://deq.idaho.gov/media/60180891/itafos-condasoda-springs-ptc-permit-2017-0050-0118.pdf>
- Idaho DEQ. (2000). *North and South Maybe Mines, Idaho Department of Environmental Quality*. Retrieved from <https://deq.idaho.gov/regional-offices-issues/pocatello/southeast-idaho-phosphate-mining/north-south-maybe-mines.aspx>
- Idaho DEQ, US EPA and US Forest Service. (October 2017). *Update: Phosphate Mine Site Investigations and Cleanups in Southeast Idaho*. Retrieved from <https://semsub.epa.gov/work/10/100072714.pdf>
- Idaho Legislature. (n.d.). *Title 47 Mines and Mining*. Retrieved from Official Website of the Idaho Legislature: <https://legislature.idaho.gov/statutesrules/idstat/Title47/T47CH15/>
- (2014). *Lanes Creek Mine Environmental Monitoring Plan*. BC.
- Lee, William H. (200, Ch. 34). *A History of Phosphate Mining of Southeast Idaho, Chapter 34, Dry Valley Mine*. Retrieved from US Geological Survey: https://pubs.usgs.gov/of/2000/of00-425/chapters/34_Dry_Valley.pdf
- Lee, William H. Department of the Interior U.S. Geological Survey. (2000). *A History of Phosphate Mining in Southeastern Idaho, Open-File Report 00-425, Version 1.0, U.S.* Retrieved from Department of the Interior U.S. Geological Survey: <http://pubs.usgs.gov/of/2000/of00-425/>
- Lee, William H. Department of the Interior U.S. Geological Survey. (2000, Ch. 16). *A History of Phosphate Mining of Southeast Idaho, Chapter 16, Maybe Canyon Mine*. Retrieved from Department of the Interior U.S. Geological Survey: https://pubs.usgs.gov/of/2000/of00-425/chapters/16_Maybe_Canyon.pdf
- Lee, William H. Department of the Interior U.S. Geological Survey. (2000, Ch. 29). *A History of Phosphate Mining of Southeast Idaho, Chapter 29, Lanes Creek Mine*. Retrieved from https://pubs.usgs.gov/of/2000/of00-425/chapters/29_Lanes_Creek.pdf
- Mabey, Don R. and Oriel, Steven S. (1970). *Gravity and Magnetic Anomalies in the Soda Spring Region, Southeastern Idaho*. Retrieved from United States Department of the Interior: <https://pubs.usgs.gov/pp/0646e/report.pdf>
- Moyle, P. R., & Piper, D. Z. . (2004). *Chapter 21 Western phosphate field — depositional and economic deposit models*. Handbook of Exploration and Environmental Geochemistry 8, 575–598.
- Norwest. (2012). *Amendment to Mine and Reclamation Plan RP509 (S00509), Lanes Creek Mine*.

- Nu-West Mining, Inc. (2012). *South Maybe Canyon Mine, Administrative Settlement Agreement Order on Consent / Consent Order, Non-Time Critical Removal Action*. Nu-West Industries, Inc.
- Nu-West Mining, Inc. (2013). *North Maybe Mine, Administrative Settlement Agreement Order on Consent / Consent Order, Remedial Investigation and Feasibility Study*. Nu-West Industries, Inc.
- Nu-West Mining, Inc. and Nu-West Industries, Inc. dba Agrium Conda Phosphate Operations (CPO). (2012, January). *Husky 1 / North Dry Ridge Mine Project, Mine and Reclamation Plan*. Retrieved from <https://eplanning.blm.gov/epl-front-office/eplanning/projectSummary.do?methodName=renderDefaultProjectSummary&projectId=30852>
- Pilon, Richard. (January 23, 2015, pp. 52). *Husky 1 Metallurgical Test Work Program (Project A14-3001B), Phase 2 Final Report, Agrium Nu-West Industries Inc.* Albatross Environmental & Processing Consulting, Inc.
- Pilon, Richard. (July 30, 2012, pp. 33). *CPO Flotation Study*. Albatross Environmental & Process Consulting Inc.
- Pilon, Richard. (June 27, 2014, pp. 19). *Husky 1 Metallurgical Test Work Program (Project A14-3001A), Phase 1 Interim Report, Agrium Nu-West Industries, Inc.* Albatross Environmental & Processing Consulting, Inc.
- Pilon, Richard. (March 26, 2014, pp 26). *Husky 1 Mineralogy and Liberations Study (Project A13-2010), Agrium Nu-West Industries Inc.,* Albatross Environmental & Processing Consulting, Inc.
- Pilon, Richard. (November 28, 2013, pp. 32). *CPO Optimization Studies Phase II*. Environmental & Process Consulting Inc.
- Piper, D. Z., & Link, P. K. (2002). *An upwelling model for the Phosphoria sea: A Permian, ocean-margin sea in the northwest United States*. AAPG BULLETIN, (7), 1217.
- SGS Laboratories. (November 5, 2013, pp. 59). *SGS Laboratories 13626-002 Draft, SGS Flotation Copy*. Albatross Environmental & Process Consulting Inc.
- Tech Law, Inc. (August 2008). *Preliminary Assessment Report, Dry Valley Mine, Soda Springs, Idaho*. US EPA.
- United States Department of the Interior Bureau of Land Management . (July 2011). *Environmental Assessment - Paris Hills Prospecting and Exploration Drilling Program EA Number: DOI -BLM -ID - I020 -2011 -0018 - EA Case Serial Numbers: IDI -36773; IDI -012982; IDI -37055*. Pocatello Field Office.
- US Department of Interior, Bureau of Land Management. (n.d.). *Caldwell Canyon Mine Environmental Impact Statement (EIS) for Bayer/Monsanto/P4 Production, LLC*. Retrieved from <https://eplanning.blm.gov/epl-front-office/eplanning/planAndProjectSite.do?methodName=dispatchToPatternPage¤tPageId=87424>
- USDA Forest Service and USDI Bureau of Land Management. (2015, May). *Dry Ridge Phosphate Exploration Project Environmental* . Retrieved from http://a123.g.akamai.net/7/123/11558/abc123/forestservic.download.akamai.com/11558/www/nepa/99319_FSPLT3_2466577.pdf
- Weber, James J. . (May 1999). *Dry Ridge Report (Federal Phosphate Lease ID-07238)*.
- Whetstone. (2014a). *Geochemistry Baseline Report for the Paris Hills Phosphate Project*.

Whetstone. (2014b). *Infiltration Modeling Results for the Planned Rock Storage Facility, Paris Hills Phosphate Project.*

Whetstone. (2015). *Numerical Modeling of Mine Dewatering for the Paris Hills Phosphate Project .*

Whetstone. (2016a). *Final Baseline Water Resources Technical Report for the Paris Hills Phosphate Project.*

WSP/Parson Brinkerhoff. (February 5, 2016). *Updated [2015] Site Assessment Report, Nu-West Industries, Conda Phosphate Operations, Soda Springs, Idaho.*



golder.com